

描述 / Descriptions

TO-220F 塑封封装 N 沟道 MOS 场效应管。N-CHANNEL MOSFET in a TO-220F Plastic Package.

特征 / Features

低栅电荷,低反馈电容,开关速度快。
Low gate charge, low crss, fast switching.

用途 / Applications

用于高效 DC/DC 转换和功率开关。
These devices are well suited for high efficiency switching DC/DC converters and switch mode power supplies.

内部等效电路 / Equivalent Circuit

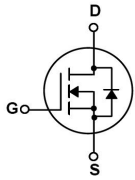

引脚排列 / Pinning



PIN 1 : G PIN 2 : D PIN 3 : S

放大及印章代码 / h_{FE} Classifications & Marking

见印章说明。 See Marking Instructions.

极限参数 / Absolute Maximum Ratings(Ta=25°C)

| 参数 Parameter | 符号 Symbol | 数值 Rating | 单位 Unit |
|---|------------------------|--------------|------------|
| Drain-Source Voltage | V_{DSS} | 250 | V |
| Drain Current | $I_D(T_C=25^\circ C)$ | 8.1 | A |
| Drain Current | $I_D(T_C=100^\circ C)$ | 5.1 | A |
| Drain Current - Pulsed | I_{DM} | 32.4 | A |
| Gate-Source Voltage | V_{GSS} | ±30 | V |
| Single Pulsed Avalanche Energy | E_{AS} | 200 | mJ |
| Repetitive Avalanche Energy | E_{AR} | 7.4 | mJ |
| Avalanche Current | I_{AR} | 8.1 | A |
| Power Dissipation | $P_D(T_C=25^\circ C)$ | 38 | W |
| Operating and Storage Temperature Range | T_J, T_{STG} | -55 to 150 | °C |

电性能参数 / Electrical Characteristics(Ta=25°C)

| 参数 Parameter | 符号 Symbol | 测试条件 Test Conditions | 最小值 Min | 典型值 Typ | 最大值 Max | 单位 Unit |
|------------------------------------|--------------|--|------------|------------|------------|------------|
| Drain-Source Breakdown Voltage | BV_{DSS} | $V_{GS}=0V$ $I_D=250\mu A$ | 250 | | | V |
| Zero Gate Voltage Drain Current | I_{DSS} | $V_{DS}=250V$ $V_{GS}=0V$ | | | 10 | μA |
| | | $V_{DS}=200V$ $T_C=125^\circ C$ | | | 100 | μA |
| Gate-Body Leakage Current Forward | I_{GSS} | $V_{GS}=\pm 30V$ $V_{DS}=0V$ | | | ±0.1 | μA |
| Gate Threshold Voltage | $V_{GS(th)}$ | $V_{DS}=V_{GS}$ $I_D=250\mu A$ | 2.0 | | 4.0 | V |
| Static Drain-Source On-Resistance | $R_{DS(on)}$ | $V_{GS}=10V$ $I_D=4.05A$ | | 0.37 | 0.45 | Ω |
| Forward Transconductance | g_{FS} | $V_{DS}=40V$ $I_D=4.05A$ | | 7.5 | | S |
| Drain-Source Diode Forward Voltage | V_{SD} | $V_{GS}=0V$ $I_S=8.1A$ | | | 1.5 | V |
| Input Capacitance | C_{iss} | $V_{DS}=25V$ $V_{GS}=0V$ $f=1.0MHz$ | | 735 | 960 | pF |
| Output Capacitance | C_{oss} | | | 120 | 155 | |
| Reverse Transfer Capacitance | C_{rss} | | | 35 | 45 | |
| Turn-On Delay Time | $t_{d(on)}$ | $V_{DD}=125V$ $I_D=8.1A$ $R_G=25\Omega$ | | 15 | 40 | ns |
| Turn-On Rise Time | t_r | | | 85 | 180 | |
| Turn-Off Delay Time | $t_{d(off)}$ | | | 80 | 170 | |
| Turn-Off Fall Time | t_f | | | 60 | 130 | |

电参数曲线图 / Electrical Characteristic Curve

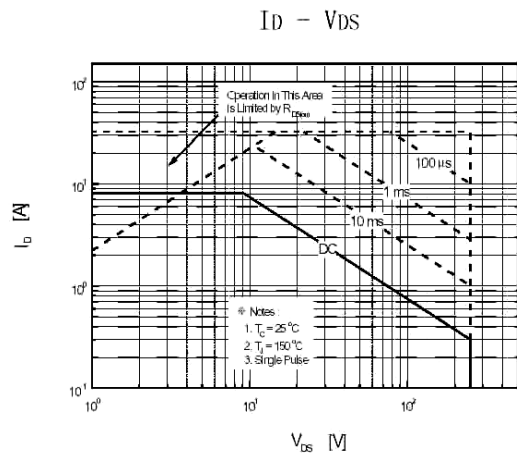
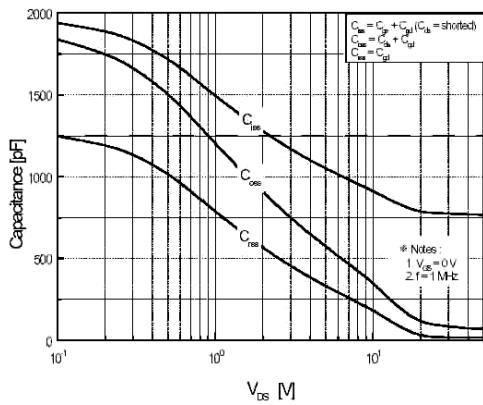
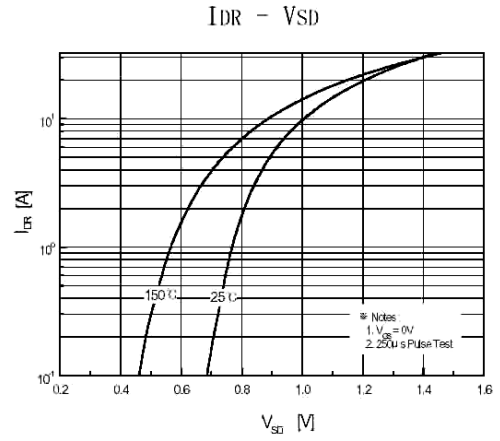
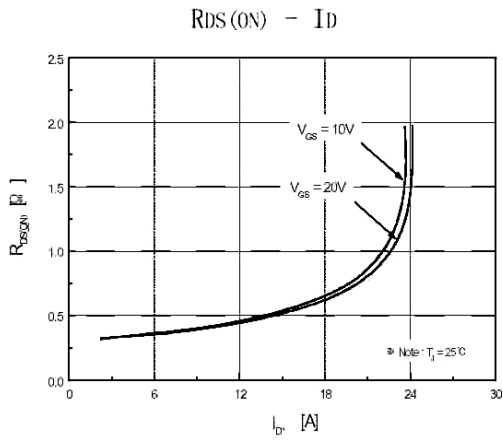
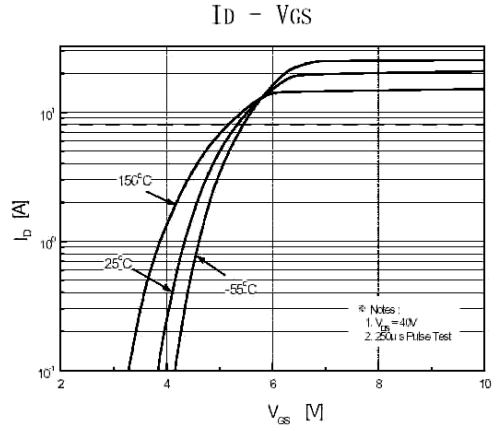
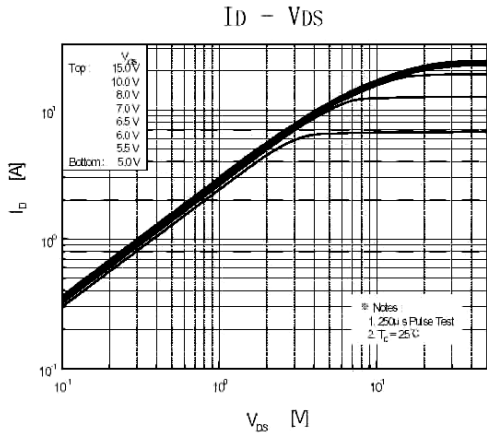

电参数曲线图 / Electrical Characteristic Curve

BVDSS - T_J

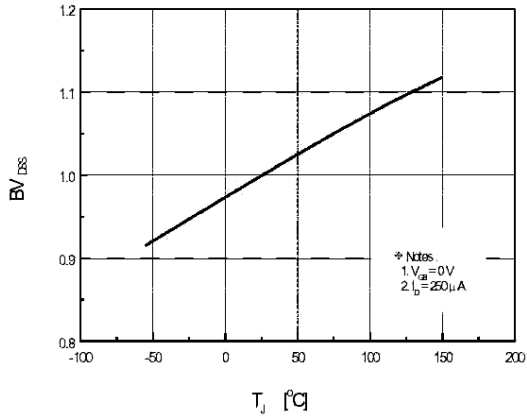

R_{DS(on)} - T_J

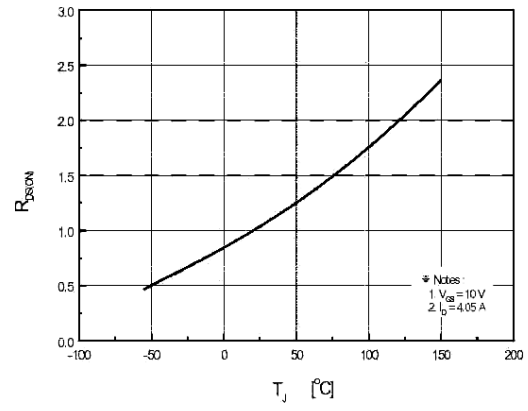

I_D - T_C

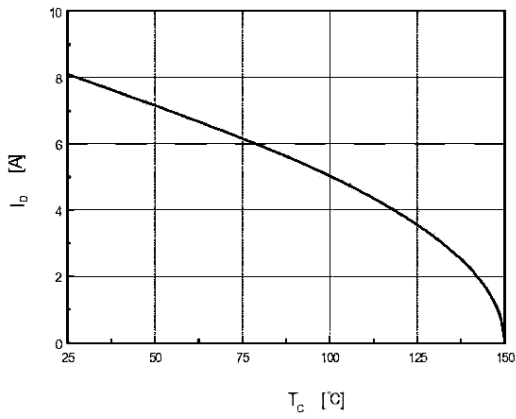

外形尺寸图 / Package Dimensions

TO-220F

单位: mm

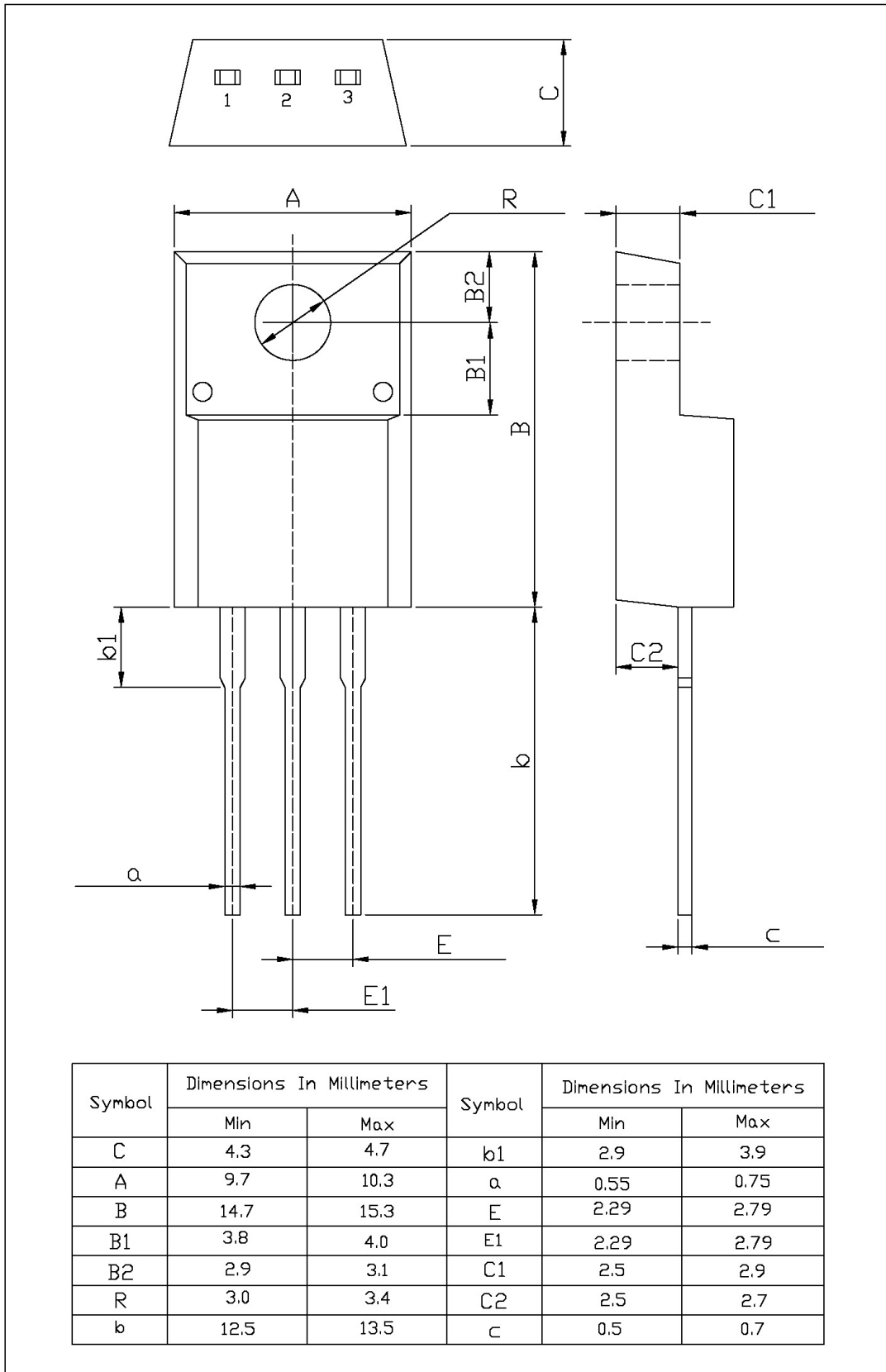

印章说明 / Marking Instructions

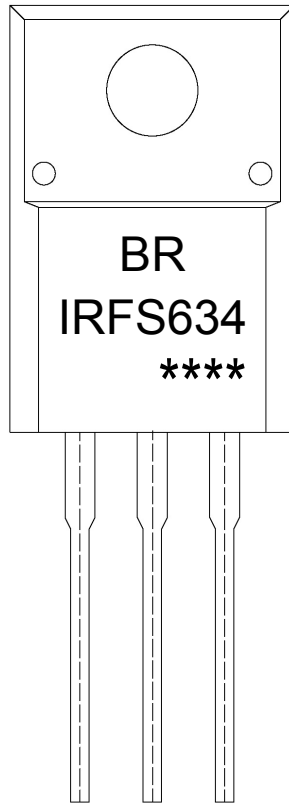

说明：

BR： 为公司代码

IRFS634： 为产品型号

****： 为生产批号代码，随生产批号变化。

Note:

BR: Company Code

IRFS634: Product Type.

****: Lot No. Code, code change with Lot No.

波峰焊温度曲线图(无铅) / Temperature Profile for Dip Soldering(Pb-Free)

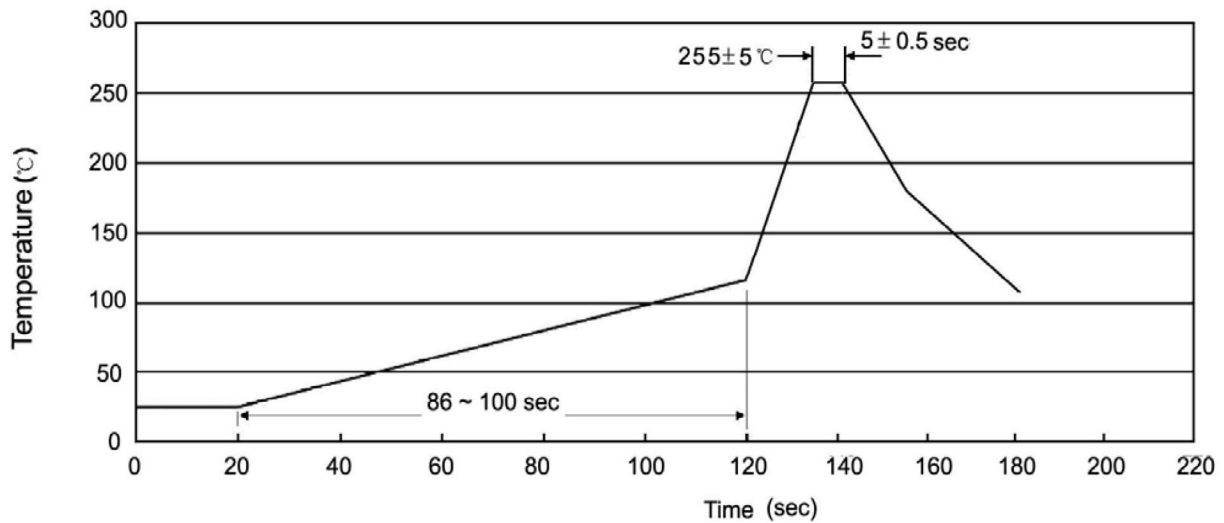

说明：

- 1、预热温度 25 ~ 150°C，时间 60 ~ 90sec；
- 2、峰值温度 255±5°C，时间持续为 5±0.5sec；
- 3、焊接制程冷却速度为 2 ~ 10°C/sec.

Note:

- 1.Preheating:25~150°C, Time:60~90sec.
- 2.Peak Temp.:255±5°C, Duration:5±0.5sec.
3. Cooling Speed: 2~10°C/sec.

耐焊接热试验条件 / Resistance to Soldering Heat Test Conditions

温度：270±5°C

时间：10±1 sec.

Temp.:270±5°C

Time:10±1 sec

包装规格 / Packaging SPEC.

散件包装 / BULK

| Package Type 封装形式 | Units 包装数量 | | | | | Dimension 包装尺寸 (unit: mm ³) | | |
|----------------------|------------------|-----------------------|------------------------|------------------------------|------------------------|---|-------------|-------------|
| | Units/Bag 只/袋 | Bags/Inner Box 袋/盒 | Units/Inner Box 只/盒 | Inner Boxes/Outer Box 盒/箱 | Units/Outer Box 只/箱 | Bag 袋 | Inner Box 盒 | Outer Box 箱 |
| TO-220/F | 200 | 10 | 2,000 | 5 | 10,000 | 135×190 | 237×172×102 | 560×245×195 |

套管包装 / TUBE

| Package Type 封装形式 | Units 包装数量 | | | | | Dimension 包装尺寸 (unit: mm ³) | | |
|----------------------|--------------------|-------------------------|------------------------|------------------------------|------------------------|---|-------------|-------------|
| | Units/Tube 只/套管 | Tubes/Inner Box 套管/盒 | Units/Inner Box 只/盒 | Inner Boxes/Outer Box 盒/箱 | Units/Outer Box 只/箱 | Tube 套管 | Inner Box 盒 | Outer Box 箱 |
| TO-220/F | 50 | 20 | 1,000 | 5 | 5,000 | 532×31.4×5.5 | 555×164×50 | 575×290×180 |

使用说明 / Notices