

用途:用于高效 DC/DC 转换和功率开关。

Purpose: These devices are well suited for high efficiency switching DC/DC converters and switch mode power supplies.

特点: 低栅电荷, 低反馈电容, 开关速度快。

Features: Low gate charge, low crss, fast switching.

极限参数/Absolute maximum ratings(Ta=25°C)

参数符号 Symbol	数值 Rating	单位 Unit
V _{DSS}	400	V
I _D (T _c =25°C)	10	A
I _D (T _c =100°C)	6.3	A
I _{DM}	40	A
V _{GSS}	±30	V
I _{AR}	10	A
E _{AS}	450	mJ
E _{AR}	13.4	mJ
P _D (T _c =25°C)	44	W
T _J , T _{STG}	-55 to 150	°C

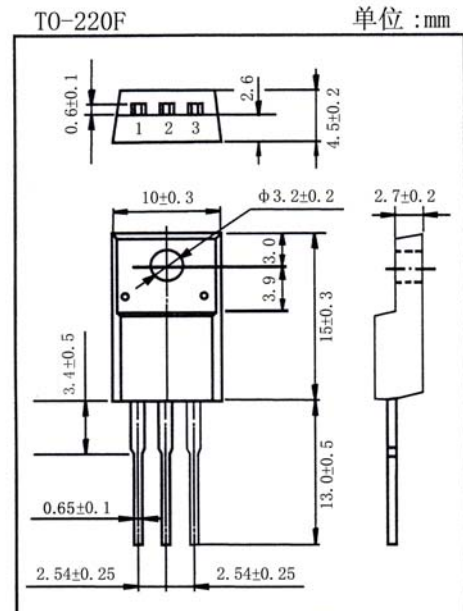

引脚: 1.G 2.D 3.S

电性能参数/Electrical Characteristics(Ta=25°C)

参数符号 Symbol	测试条件 Test Conditions	最小值 Min	典型值 Typ	最大值 Max	单位 Unit
BV _{DSS}	V _{GS} =0V I _D =250 μA	400			V
I _{DSS}	V _{DS} =400V V _{GS} =0V			10	μA
	V _{DS} =320V T _c =125°C			100	μA
I _{GSS}	V _{GS} =±30V V _{DS} =0V			±0.1	μA
V _{GS(th)}	V _{DS} =V _{GS} I _D =250 μA	2.0		4.0	V
R _{DS(on)}	V _{GS} =10V I _D =5.0A		0.44	0.55	Ω
g _{FS}	V _{DS} =40V I _D =5.0A		9.0		S
V _{SD}	V _{GS} =0V I _S =10A			1.5	V
C _{iss}	V _{DS} =25V V _{GS} =0V f=1.0MHz		1570	2040	pF
C _{oss}			150	195	
C _{rss}			15	20	
t _{d(on)}	V _{DD} =200V I _D =10A R _G =25 Ω		25	60	ns
t _r			75	160	
t _{d(off)}			115	240	
t _f			70	150	

IRFS740 (CS740F)

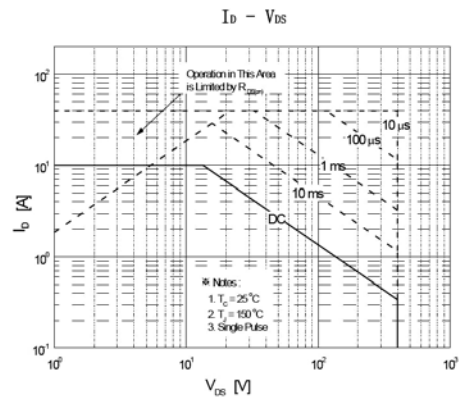
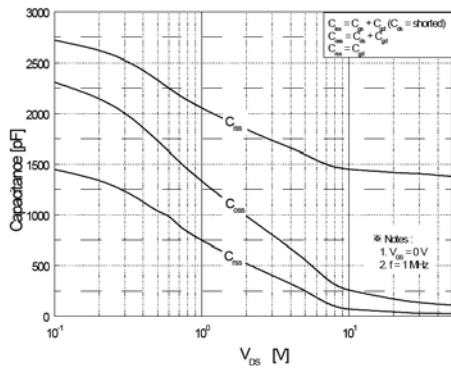
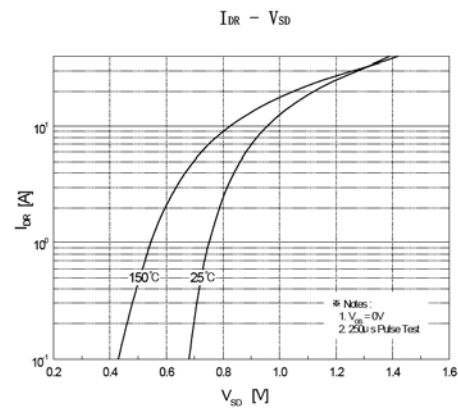
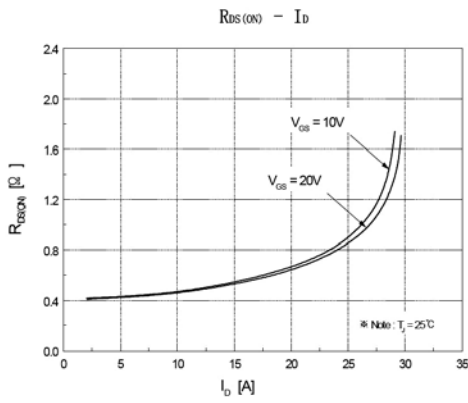
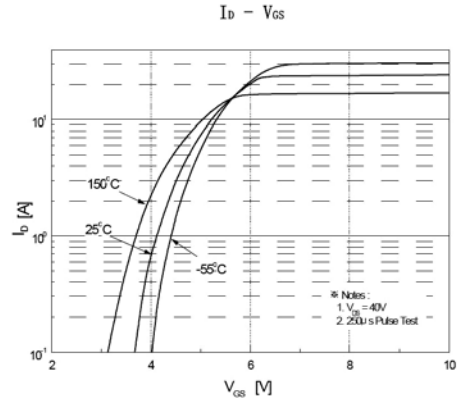
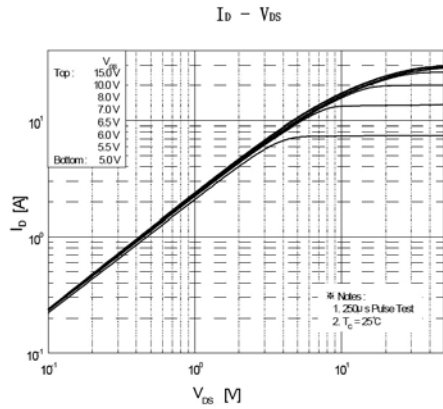

IRFS740 (CS740F)

