

IRFSL11N50A

HEXFET® Power MOSFET

- Dynamic dv/dt Rating
- Repetitive Avalanche Rated
- Fast Switching
- Ease of Paraleling
- Simple Drive Requirements

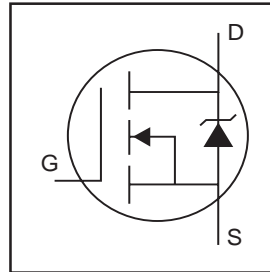

$V_{DSS} = 500V$
$R_{DS(on)} = 0.55\Omega$
$I_D = 11A$

Description

Third Generation HEXFETs from International Rectifier provide the designer with the best combination of fast switching, ruggedized device design, low on-resistance and cost-effectiveness.

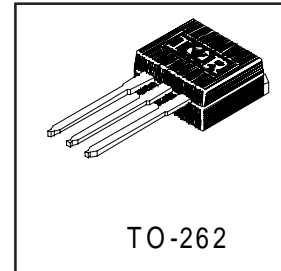

Absolute Maximum Ratings

	Parameter	Max.	Units
$I_D @ T_C = 25^\circ C$	Continuous Drain Current, $V_{GS} @ 10V$	11	A
$I_D @ T_C = 100^\circ C$	Continuous Drain Current, $V_{GS} @ 10V$	7.0	
I_{DM}	Pulsed Drain Current ①	44	
$P_D @ T_C = 25^\circ C$	Power Dissipation	190	W
	Linear Derating Factor	1.3	W/°C
V_{GS}	Gate-to-Source Voltage	± 30	V
E_{AS}	Single Pulse Avalanche Energy②	390	mJ
I_{AR}	Avalanche Current①	11	A
E_{AR}	Repetitive Avalanche Energy①	19	mJ
dv/dt	Peak Diode Recovery dv/dt ③	4.1	V/ns
T_J	Operating Junction and	-55 to + 175	°C
T_{STG}	Storage Temperature Range		
	Soldering Temperature, for 10 seconds	300 (1.6mm from case)	

Thermal Resistance

	Parameter	Typ.	Max.	Units
$R_{\theta JC}$	Junction-to-Case	—	0.75	°C
$R_{\theta JA}$	Junction-to-Ambient	—	40	

IRFSL11N50A

International
IR Rectifier

Electrical Characteristics @ $T_J = 25^\circ\text{C}$ (unless otherwise specified)

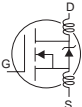
	Parameter	Min.	Typ.	Max.	Units	Conditions
$V_{(BR)DSS}$	Drain-to-Source Breakdown Voltage	500	—	—	V	$V_{GS} = 0V, I_D = 250\mu A$
$\Delta V_{(BR)DSS}/\Delta T_J$	Breakdown Voltage Temp. Coefficient	—	0.57	—	V/°C	Reference to 25°C , $I_D = 1\text{mA}$
$R_{DS(on)}$	Static Drain-to-Source On-Resistance	—	—	0.55	Ω	$V_{GS} = 10V, I_D = 6.6A$ ④
$V_{GS(th)}$	Gate Threshold Voltage	2.0	—	4.0	V	$V_{DS} = V_{GS}, I_D = 250\mu A$
g_{fs}	Forward Transconductance	6.0	—	—	S	$V_{DS} = 50V, I_D = 6.6A$
I_{DSS}	Drain-to-Source Leakage Current	—	—	25	μA	$V_{DS} = 500V, V_{GS} = 0V$
		—	—	250		$V_{DS} = 400V, V_{GS} = 0V, T_J = 150^\circ\text{C}$
I_{GSS}	Gate-to-Source Forward Leakage	—	—	100	nA	$V_{GS} = 30V$
	Gate-to-Source Reverse Leakage	—	—	-100		$V_{GS} = -30V$
Q_g	Total Gate Charge	—	—	51	nC	$I_D = 11A$
Q_{gs}	Gate-to-Source Charge	—	—	12		$V_{DS} = 400V$
Q_{gd}	Gate-to-Drain ("Miller") Charge	—	—	23		$V_{GS} = 10V$, See Fig. 6 and 13 ④
$t_{d(on)}$	Turn-On Delay Time	—	14	—	ns	$V_{DD} = 250V$
t_r	Rise Time	—	34	—		$I_D = 11A$
$t_{d(off)}$	Turn-Off Delay Time	—	32	—		$R_G = 9.1\Omega$
t_f	Fall Time	—	27	—		$R_D = 22\Omega$, See Fig. 10 ④
L_D	Internal Drain Inductance	—	4.5	—	nH	Between lead, 6mm (0.25in.) from package and center of die contact
L_S	Internal Source Inductance	—	7.5	—		
C_{iss}	Input Capacitance	—	1426	—	pF	$V_{GS} = 0V$
C_{oss}	Output Capacitance	—	208	—		$V_{DS} = 25V$
C_{rss}	Reverse Transfer Capacitance	—	9.6	—		$f = 1.0\text{MHz}$, See Fig. 5
C_{oss}	Output Capacitance	—	1954	—		$V_{GS} = 0V, V_{DS} = 1.0V, f = 1.0\text{MHz}$
C_{oss}	Output Capacitance	—	53	—		$V_{GS} = 0V, V_{DS} = 400V, f = 1.0\text{MHz}$
$C_{oss \text{ eff.}}$	Effective Output Capacitance ⑤	—	110	—		$V_{GS} = 0V, V_{DS} = 0V \text{ to } 400V$

Source-Drain Ratings and Characteristics

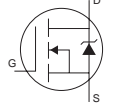
	Parameter	Min.	Typ.	Max.	Units	Conditions
I_S	Continuous Source Current (Body Diode)	—	—	11	A	MOSFET symbol showing the integral reverse p-n junction diode. 
I_{SM}	Pulsed Source Current (Body Diode) ①	—	—	44		
V_{SD}	Diode Forward Voltage	—	—	1.5	V	$T_J = 25^\circ\text{C}, I_S = 11A, V_{GS} = 0V$ ④
t_{rr}	Reverse Recovery Time	—	530	790	ns	$T_J = 25^\circ\text{C}, I_F = 11A$
Q_{rr}	Reverse Recovery Charge	—	3.4	5.1	μC	$di/dt = 100A/\mu s$ ④
t_{on}	Forward Turn-On Time	Intrinsic turn-on time is negligible (turn-on is dominated by L_S+L_D)				

Notes:

① Repetitive rating; pulse width limited by max. junction temperature. (See fig. 11)

② Starting $T_J = 25^\circ\text{C}$, $L = 6.4\text{mH}$
 $R_G = 25\Omega, I_{AS} = 11A$. (See Figure 12)

③ $I_{SD} \leq 11A, di/dt \leq 185A/\mu s, V_{DD} \leq V_{(BR)DSS}$,
 $T_J \leq 175^\circ\text{C}$

④ Pulse width $\leq 300\mu s$; duty cycle $\leq 2\%$.

⑤ $C_{oss \text{ eff.}}$ is a fixed capacitance that gives the same charging time as C_{oss} while V_{DS} is rising from 0 to 80% V_{DSS}

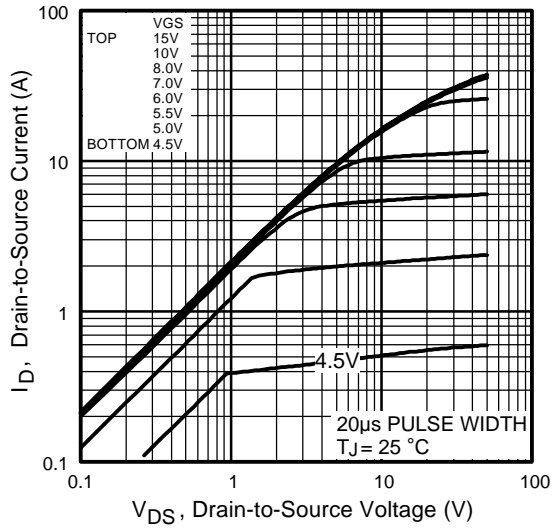

Fig 1. Typical Output Characteristics

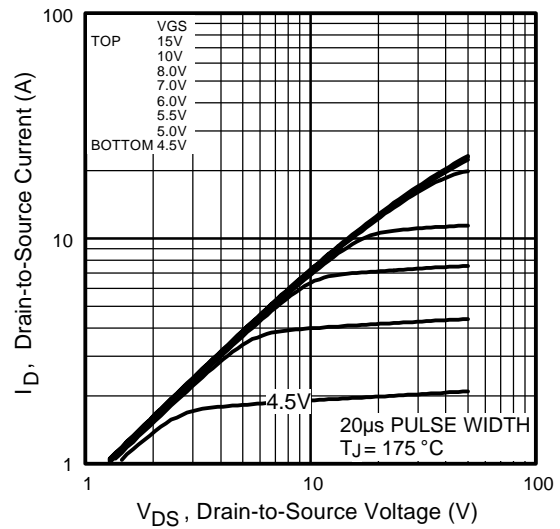

Fig 2. Typical Output Characteristics

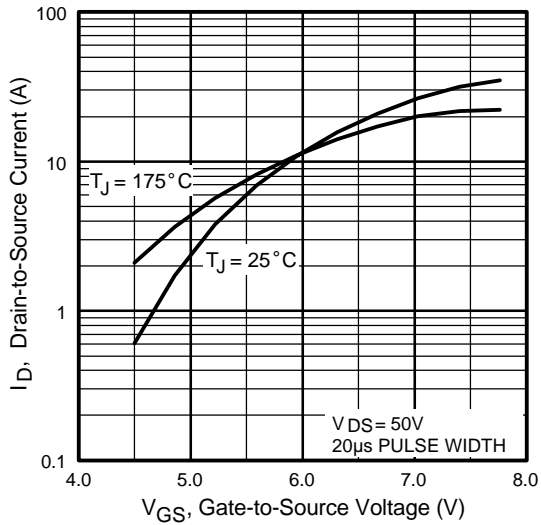

Fig 3. Typical Transfer Characteristics

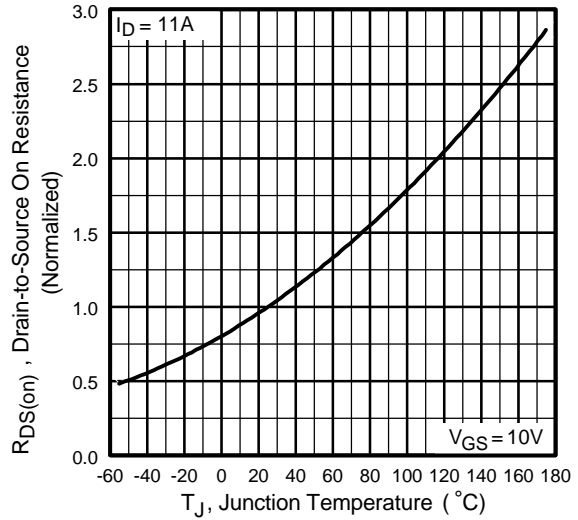

Fig 4. Normalized On-Resistance Vs. Temperature

IRFSL11N50A

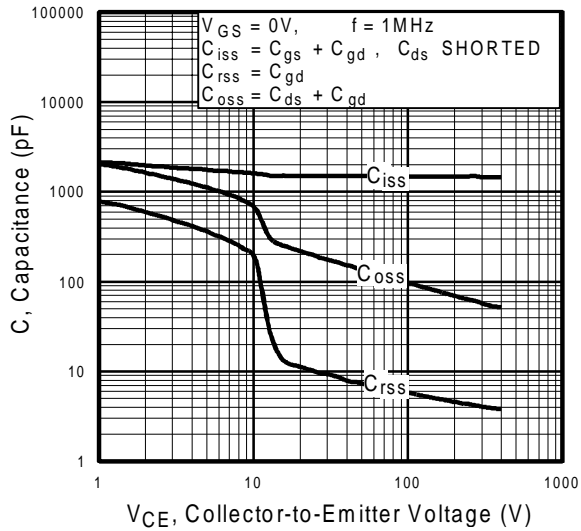

Fig 5. Typical Capacitance Vs. Drain-to-Source Voltage

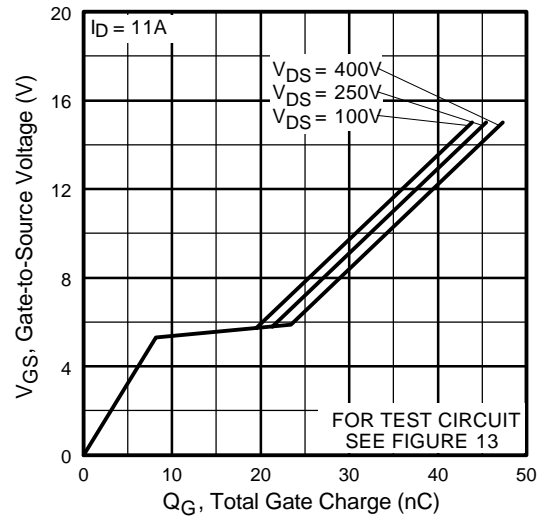

Fig 6. Typical Gate Charge Vs. Gate-to-Source Voltage

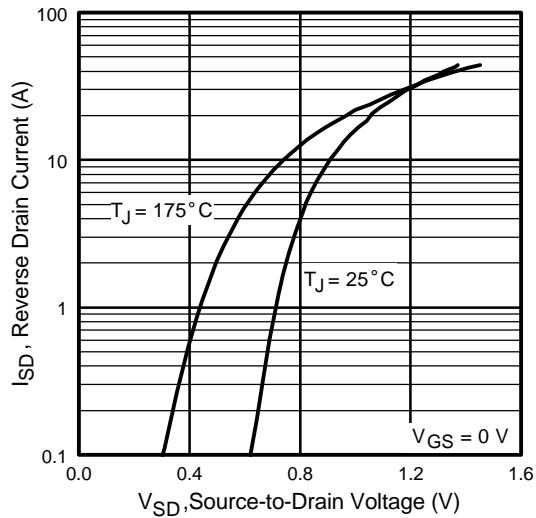

Fig 7. Typical Source-Drain Diode Forward Voltage

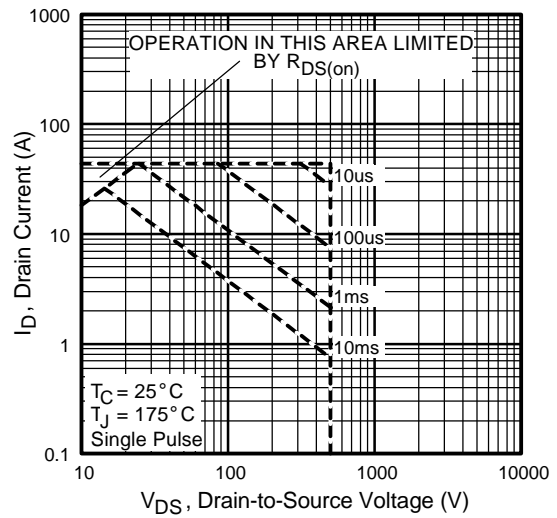

Fig 8. Maximum Safe Operating Area

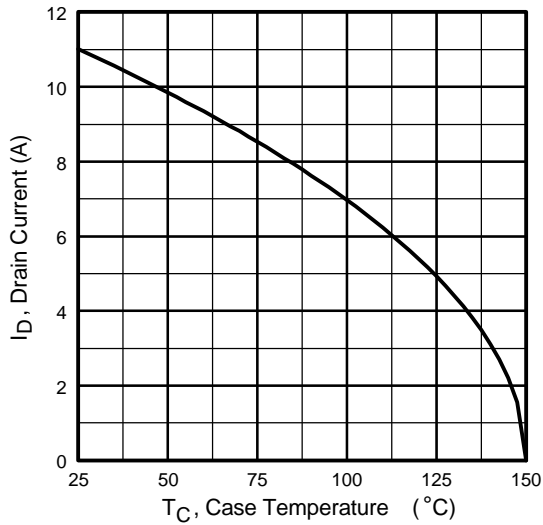

Fig 9. Maximum Drain Current Vs. Case Temperature

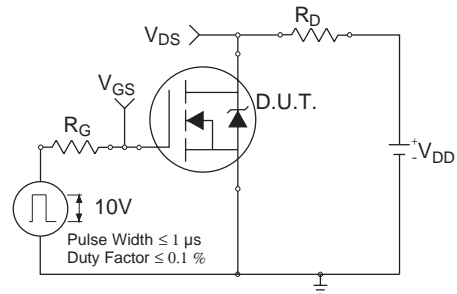

Fig 10a. Switching Time Test Circuit

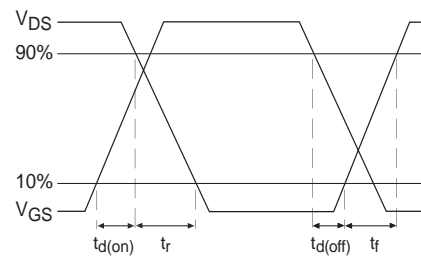

Fig 10b. Switching Time Waveforms

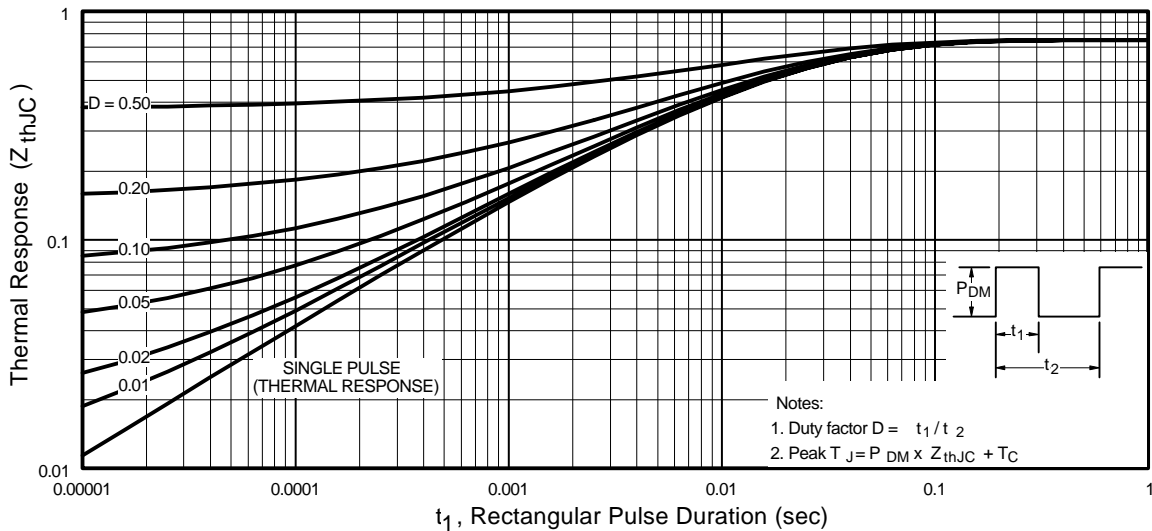

Fig 11. Maximum Effective Transient Thermal Impedance, Junction-to-Case

IRFSL11N50A

International
IR Rectifier

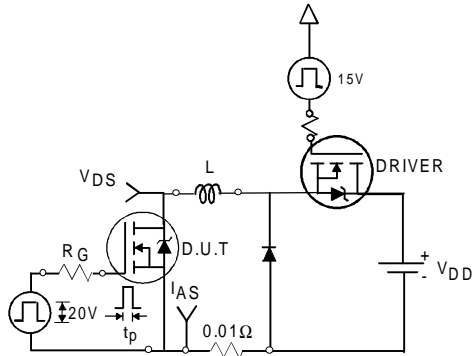

Fig 12a. Unclamped Inductive Test Circuit

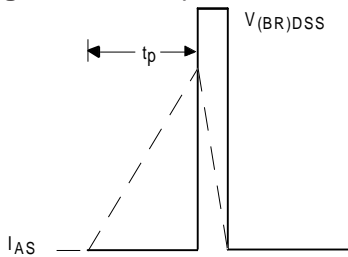

Fig 12b. Unclamped Inductive Waveforms

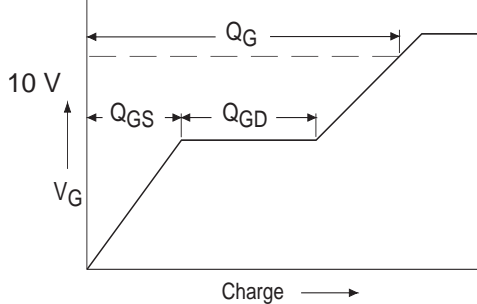

Fig 13a. Basic Gate Charge Waveform

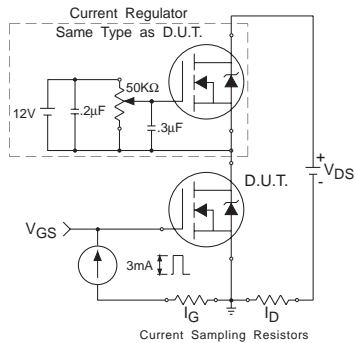

Fig 13b. Gate Charge Test Circuit

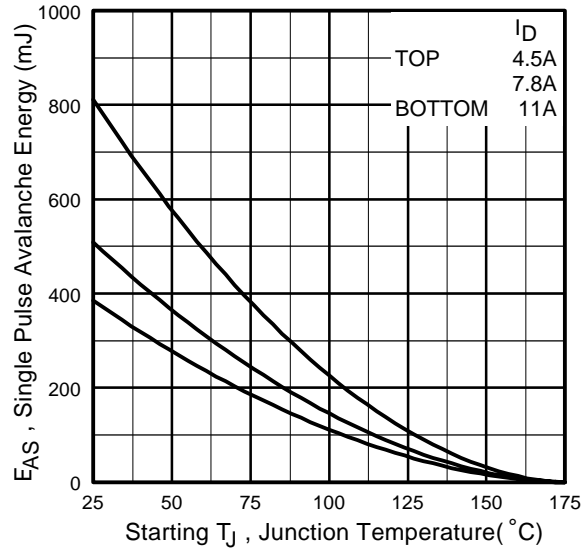

Fig 12c. Maximum Avalanche Energy Vs. Drain Current

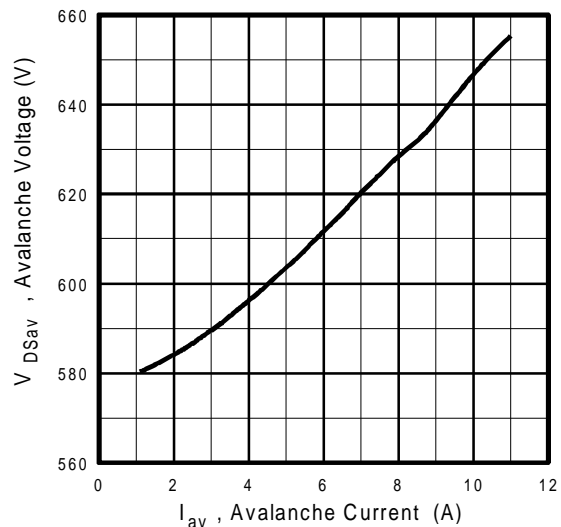
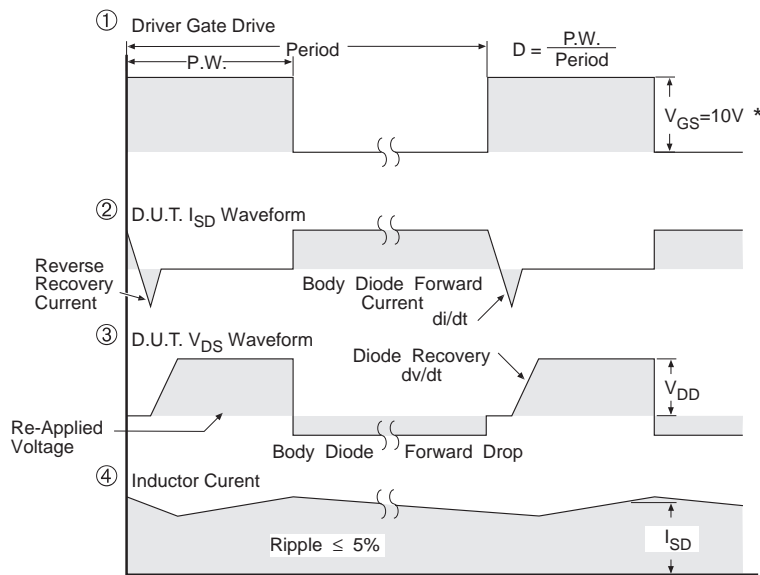
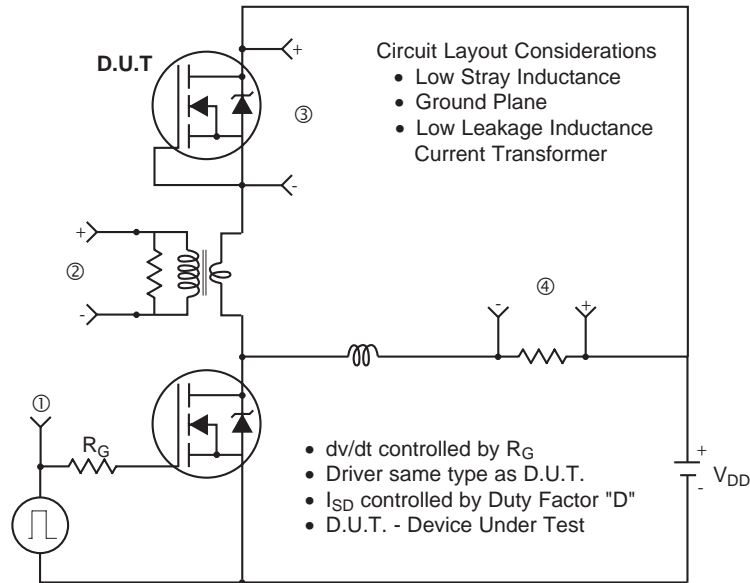

Fig 12d. Typical Drain-to-Source Voltage Vs. Avalanche Current

Peak Diode Recovery dv/dt Test Circuit



* $V_{GS} = 5V$ for Logic Level Devices

Fig 14. For N-Channel HEXFETS

IRFSL11N50A

International
IR Rectifier

Package Outline

TO-262 Outline

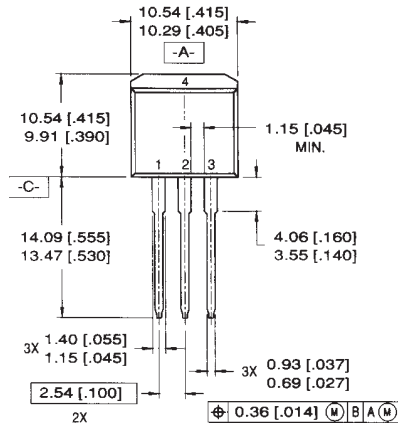

LEAD ASSIGNMENTS

- | | |
|-----------|------------|
| 1 = GATE | 3 = SOURCE |
| 2 = DRAIN | 4 = DRAIN |

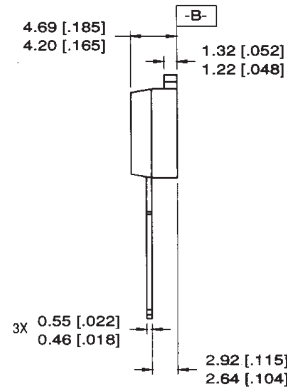

NOTES:

1. DIMENSIONING & TOLERANCING PER ANSI Y14.5M-1982
2. CONTROLLING DIMENSION: INCH.
3. DIMENSIONS ARE SHOWN IN MILLIMETERS [INCHES].
4. HEATSINK & LEAD DIMENSIONS DO NOT INCLUDE BURRS.

Part Marking Information

TO-262

EXAMPLE: THIS IS AN IRL3103L
 LOT CODE 1789
 ASSEMBLED ON WW 19, 1997
 IN THE ASSEMBLY LINE "C"

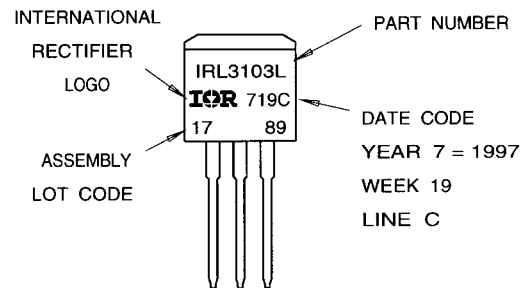

International
IR Rectifier

WORLD HEADQUARTERS: 233 Kansas St., El Segundo, California 90245, Tel: (310) 322 3331

IR GREAT BRITAIN: Hurst Green, Oxted, Surrey RH8 9BB, UK Tel: ++ 44 1883 732020

IR CANADA: 15 Lincoln Court, Brampton, Ontario L6T3Z2, Tel: (905) 453 2200

IR GERMANY: Saalburgstrasse 157, 61350 Bad Homburg Tel: ++ 49 6172 96590

IR ITALY: Via Liguria 49, 10071 Borgaro, Torino Tel: ++ 39 11 451 0111

IR FAR EAST: K&H Bldg., 2F, 30-4 Nishi-Ikebukuro 3-Chome, Toshima-Ku, Tokyo Japan 171 Tel: 81 3 3983 0086

IR SOUTHEAST ASIA: 1 Kim Seng Promenade, Great World City West Tower, 13-11, Singapore 237994 Tel: ++ 65 838 4630

IR TAIWAN: 16 Fl. Suite D. 207, Sec. 2, Tun Haw South Road, Taipei, 10673, Taiwan Tel: 886-2-2377-9936

<http://www.irf.com/>

Data and specifications subject to change without notice. 9/99

www.irf.com