

REPETITIVE AVALANCHE AND dv/dt RATED

HEXFET® TRANSISTORS

- IRFR9020
- IRFR9022
- IRFU9020
- IRFU9022

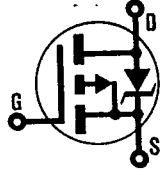

P-CHANNEL

D-PAK

-50 Volt, 0.20 Ohm HEXFET

The HEXFET® technology is the key to International Rectifier's advanced line of power MOSFET transistors. The efficient geometry and unique processing of this latest "State of the Art" design achieves: very low on-state resistance combined with high transconductance; superior reverse energy and diode recovery dv/dt capability.

The HEXFET transistors also feature all of the well established advantages of MOSFETs such as voltage control, very fast switching, ease of paralleling and temperature stability of the electrical parameters.

Surface mount packages enhance circuit performance by reducing stray inductances and capacitance. The D-Pak (TO-252AA) surface mount package brings the advantages of HEXFETs to high volume applications where PC Board surface mounting is desirable. The surface mount option IRFR9020 is provided on 16mm tape. The straight lead option IRFU9020 of the device is called the I-Pak (TO-251AA).

They are well suited for applications where limited heat dissipation is required such as, computers and peripherals, telecommunications equipment, DC/DC converters, and a wide range of consumer products.

Product Summary

| Part Number | BVDSS | R _{DS(on)} | I _D |
|-------------|-------|---------------------|----------------|
| IRFR9020 | -50V | 0.28Ω | -9.9A |
| IRFR9022 | -50V | 0.33Ω | -9.0A |
| IRFU9020 | -50V | 0.28Ω | -9.9A |
| IRFU9022 | -50V | 0.33Ω | -9.0A |

FEATURES:

- Surface Mountable (Order As IRFR9020)
- Straight Lead Option (Order As IRFU9020)
- Repetitive Avalanche Ratings
- Dynamic dv/dt Rating
- Simple Drive Requirements
- Ease of Paralleling

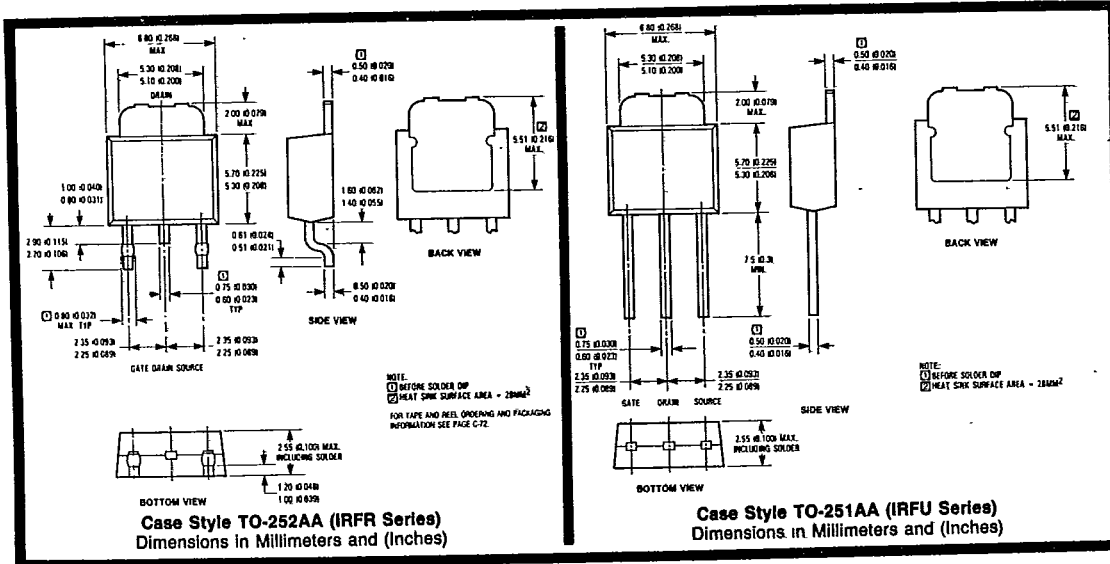

Absolute Maximum Ratings

| Parameter | IRFR9020, IRFU9020 | IRFR9022, IRFU9022 | Units |
|---|---|--------------------|------------------|
| $I_D @ T_C = 25^\circ\text{C}$ Continuous Drain Current | -9.9 | -9.0 | A |
| $I_D @ T_C = 100^\circ\text{C}$ Continuous Drain Current | -6.3 | -5.7 | A |
| I_{DM} Pulsed Drain Current (1) | -40 | -36 | A |
| $P_D @ T_C = 25^\circ\text{C}$ Max. Power Dissipation | 42 | | W |
| Linear Derating Factor | 0.33 | | W/K (5) |
| V_{GS} Gate-to-Source Voltage | ± 20 | | V |
| E_{AS} Single Pulse Avalanche Energy (2) | 440 (See Fig. 14) | | mJ |
| I_{AR} Avalanche Current (Repetitive or Non-Repetitive) (1) | -9.9 (See E_{AR}) | | A |
| E_{AR} Repetitive Avalanche Energy (1) | 4.2 (See I_{AR}) | | mJ |
| dv/dt Peak Diode recovery dv/dt (3) | 5.8 (See Fig. 17) | | V/ns |
| T_J Operating Junction Temperature Range | -55 to 150 | | $^\circ\text{C}$ |
| T_{STG} Storage Temperature Range | -55 to 150 | | $^\circ\text{C}$ |
| Lead Temperature | 300 (0.063 in. (1.6mm) from case for 10s) | | $^\circ\text{C}$ |

Electrical Characteristics @ $T_J = 25^\circ\text{C}$ (Unless Otherwise Specified)

| Parameter | Type | Min. | Typ. | Max. | Units | Test Conditions |
|---|----------|------|------|------|---------------|---|
| BV_{DSS} Drain-to-Source Breakdown Voltage | All | -50 | | | V | $V_{GS} = 0V, I_D = -250\mu\text{A}$ |
| $R_{DS(on)}$ Static Drain-to-Source On-State Resistance (4) | IRFR9020 | — | 0.20 | 0.28 | Ω | $V_{GS} = -10V, I_D = 5.7A$ |
| | IRFU9020 | — | 0.28 | 0.33 | | |
| | IRFR9022 | — | 0.28 | 0.33 | | |
| $I_{D(on)}$ On-State Drain Current (4) | IRFR9020 | -9.9 | — | — | A | $V_{DS} > I_{D(on)} \times R_{DS(on)}$ Max. $V_{GS} = -10V$ |
| | IRFU9020 | -9.9 | — | — | | |
| $V_{GS(th)}$ Gate Threshold Voltage | ALL | -2.0 | — | -4.0 | V | $V_{DS} = V_{GS}, I_D = -250\mu\text{A}$ |
| g_{fs} Forward Transconductance (4) | ALL | 2.3 | 3.5 | — | S(V) | $V_{DS} \leq -50V, I_{DS} = -5.7A$ |
| I_{DSS} Zero Gate Voltage Drain Current | ALL | — | — | 250 | μA | $V_{DS} = \text{Max. Rating}, V_{GS} = 0V$ |
| | | — | — | 1000 | | |
| I_{GSS} Gate-to-Source Leakage Forward | ALL | — | — | -500 | nA | $V_{GS} = -20V$ |
| I_{GSS} Gate-to-Source Leakage Reverse | ALL | — | — | 500 | nA | $V_{GS} = 20V$ |
| Q_g Total Gate Charge | ALL | — | 9.4 | 14 | nC | $V_{GS} = -10V, I_D = -9.7A$ |
| Q_{gs} Gate-to-Source Charge | ALL | — | 4.3 | 6.5 | nC | $V_{DS} = 0.8 \times \text{Max. Rating}$ |
| Q_{gd} Gate-to-Drain ("Miller") Charge | ALL | — | 4.3 | 6.5 | nC | See Fig. 16 (Independent of operating temperature) |
| $t_{d(on)}$ Turn-On Delay Time | ALL | — | 8.2 | 12 | ns | $V_{DD} = -25V, I_D = -9.7A, R_G = 18\Omega$ |
| t_r Rise Time | ALL | — | 57 | 88 | ns | $R_D = 2.4\Omega$ |
| $t_{d(off)}$ Turn-Off Delay Time | ALL | — | 12 | 18 | ns | See Fig. 15 |
| t_f Fall Time | ALL | — | 25 | 38 | ns | (Independent of operating temperature) |
| L_D Internal Drain Inductance | ALL | — | 4.5 | — | nH | Measured from the drain lead, 6mm (0.25 in.) from package to center of die. |
| L_S Internal Source Inductance | ALL | — | 7.5 | — | nH | Measured from the source lead, 6mm (0.25 in.) from package to source bonding pad. |
| C_{iss} Input Capacitance | ALL | — | 490 | — | pF | $V_{GS} = 0V, V_{DS} = -25V$ |
| C_{oss} Output Capacitance | ALL | — | 320 | — | pF | $f = 1.0 \text{ MHz}$ |
| C_{rss} Reverse Transfer Capacitance | ALL | — | 70 | — | pF | See Fig. 10 |

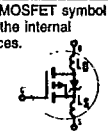

Source-Drain Diode Ratings and Characteristics

| Parameter | Type | Min. | Typ. | Max. | Units | Test Conditions |
|---|------|--|------|------|---------------|---|
| I_S Continuous Source Current (Body Diode) | ALL | — | — | -9.9 | A | Modified MOSFET symbol showing the integral Reverse p-n junction rectifier.  |
| I_{SM} Pulsed Source Current (Body Diode) ① | ALL | — | — | -40 | A | |
| V_{SD} Diode Forward Voltage ④ | ALL | — | — | -6.3 | V | $T_J = 25^\circ\text{C}$, $I_S = -9.9\text{A}$, $V_{GS} = 0\text{V}$ |
| t_{rr} Reverse Recovery Time | ALL | 56 | 110 | 280 | ns | $T_J = 25^\circ\text{C}$, $I_F = -9.7\text{A}$, $di/dt = 100\text{ A}/\mu\text{s}$ |
| Q_{RR} Reverse Recovery Charge | ALL | 0.17 | 0.34 | 0.85 | μC | |
| t_{on} Forward Turn-On Time | ALL | Intrinsic turn-on time is negligible. Turn-on speed is substantially controlled by $L_S + L_D$. | | | | |

Thermal Resistance

| | | | | | | |
|--------------------------------|-----|---|-----|-----|-------|------------------------|
| R_{thJC} Junction-to-Case | ALL | — | — | 3.0 | K/W ⑤ | |
| R_{thCS} Case-to-Sink | ALL | — | 1.7 | — | K/W ⑤ | Typical solder mount ⑥ |
| R_{thJA} Junction-to-Ambient | ALL | — | — | 110 | K/W ⑤ | Typical socket mount |



- ① Repetitive Rating; Pulse width limited by maximum junction temperature (see figure 5)
- ② @ $V_{DD} = -25\text{V}$, Starting $T_J = 25^\circ\text{C}$, $L = 5.1\text{ mH}$, $R_G = 25\Omega$, Peak $I_L = -9.9\text{A}$
- ③ $I_{SD} \leq -9.9\text{A}$, $di/dt \leq -120\text{ A}/\mu\text{s}$, $V_{DD} \leq 40\text{V}$, $T_J \leq 150^\circ\text{C}$, Suggested $R_G = 18\Omega$
- ④ Pulse width $\leq 300\ \mu\text{s}$; Duty Cycle $\leq 2\%$
- ⑤ $K/W = \text{ }^\circ\text{C}/\text{W}$
 $W/K = \text{W}/\text{ }^\circ\text{C}$
- ⑥ Mounting pad must cover heatsink surface area. See case style drawing on front page.

The information shown on the following graphs applies also to the IRFU devices.

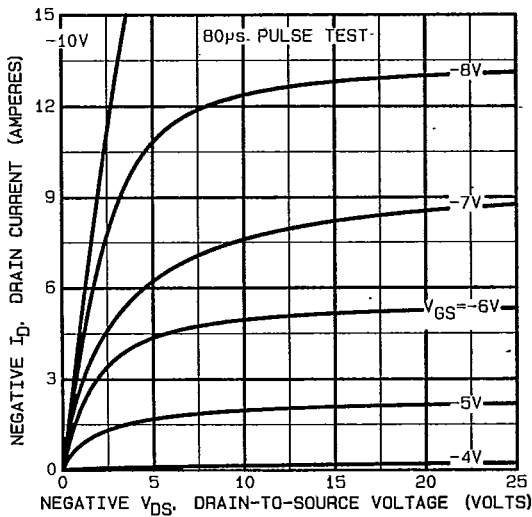

Fig. 1 — Typical Output Characteristics

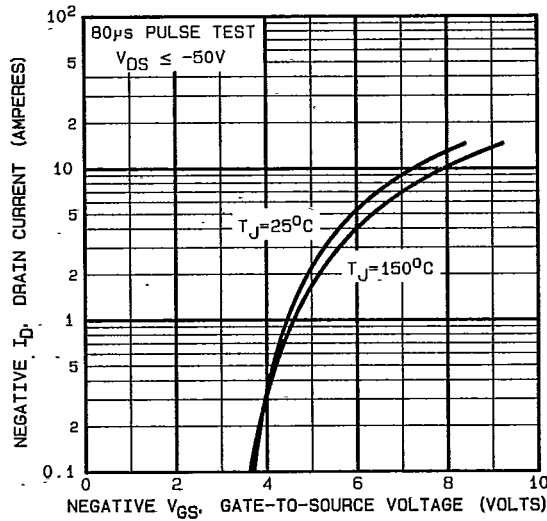

Fig. 2 — Typical Transfer Characteristics

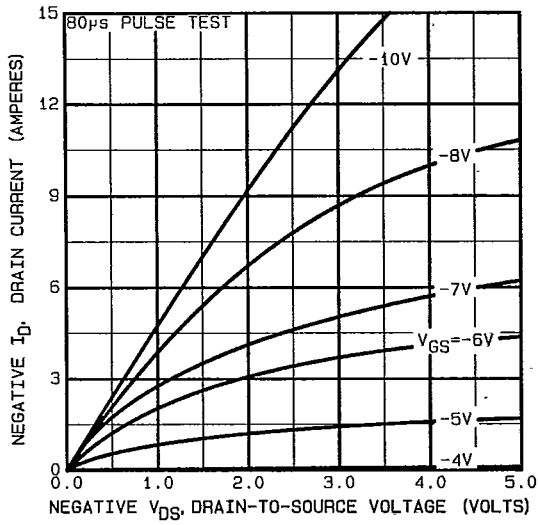

Fig. 3 — Typical Saturation Characteristics

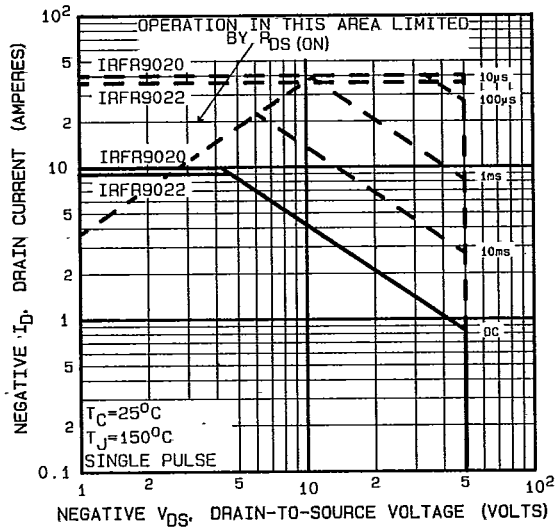

Fig. 4 — Maximum Safe Operating Area

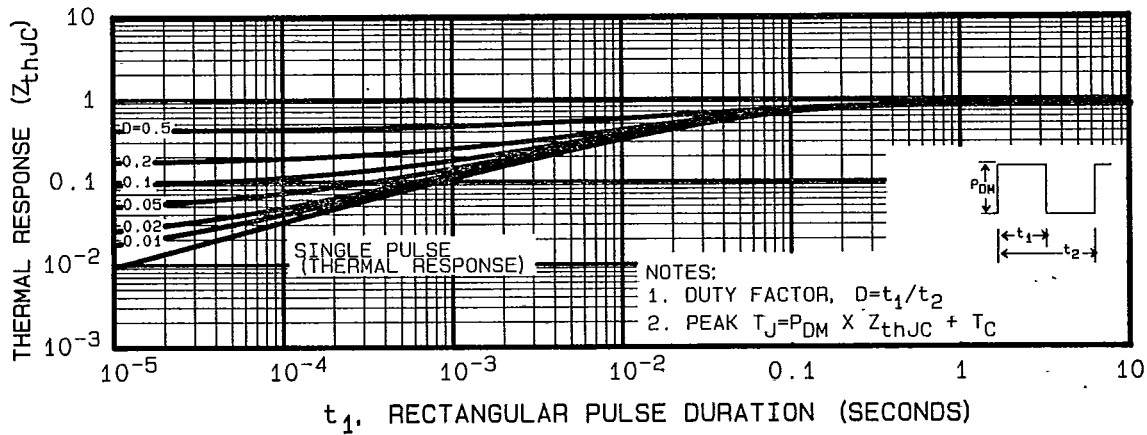

Fig. 5 — Maximum Effective Transient Thermal Impedance, Junction-to-Case Vs. Pulse Duration

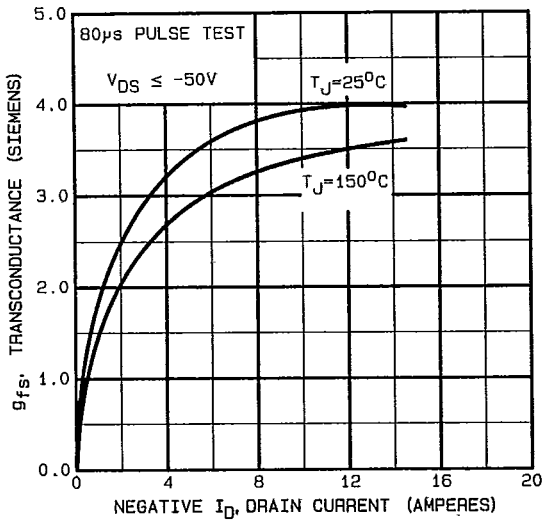

Fig. 6 — Typical Transconductance Vs. Drain Current

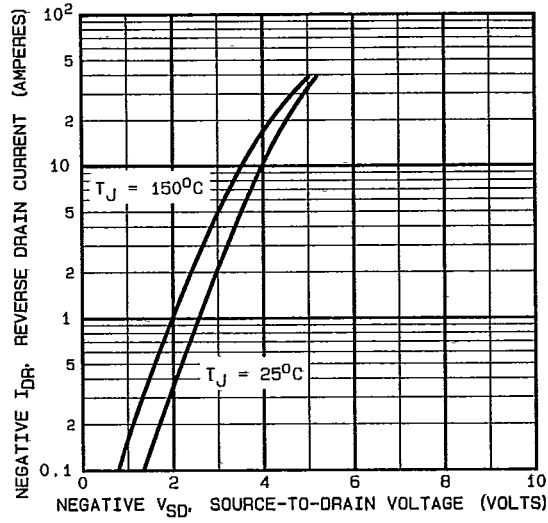

Fig. 7 — Typical Source-Drain Diode Forward Voltage

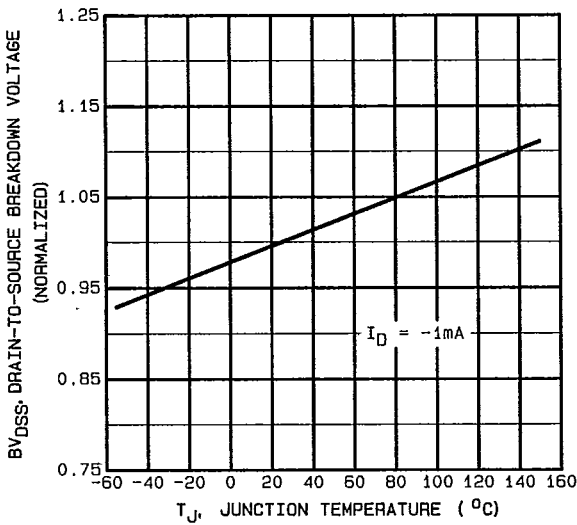

Fig. 8 — Breakdown Voltage Vs. Temperature

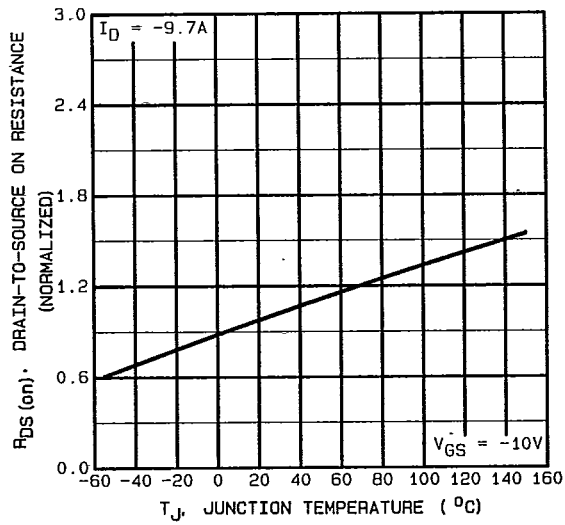

Fig. 9 — Normalized On-Resistance Vs. Temperature

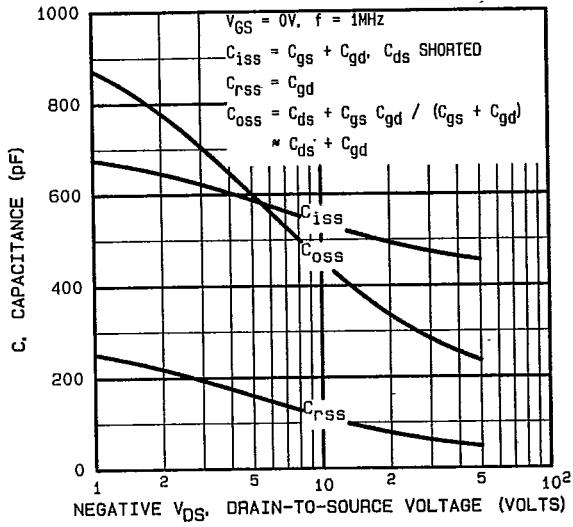

Fig. 10 — Typical Capacitance Vs. Drain-to-Source Voltage

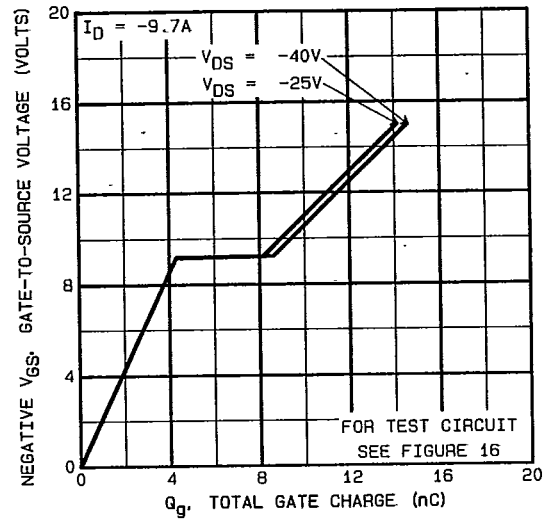

Fig. 11 — Typical Gate Charge Vs. Gate-to-Source Voltage

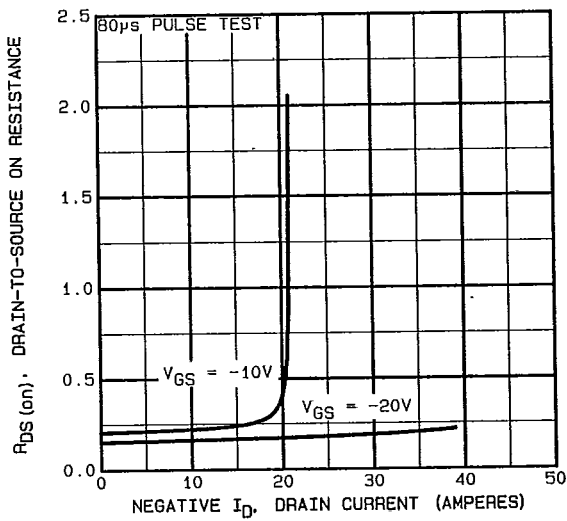

Fig. 12 — Typical On-Resistance Vs. Drain Current

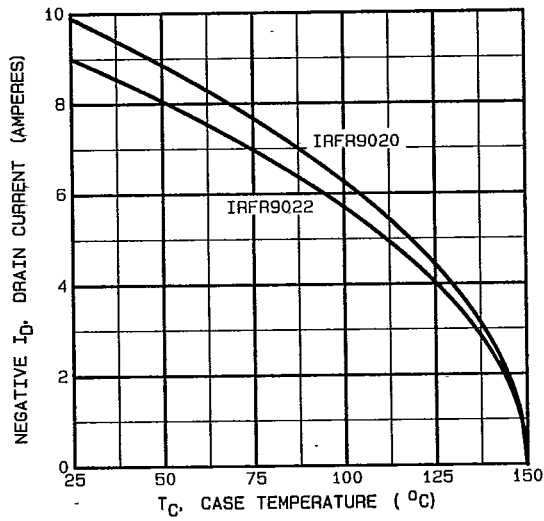

Fig. 13 — Maximum Drain Current Vs. Case Temperature

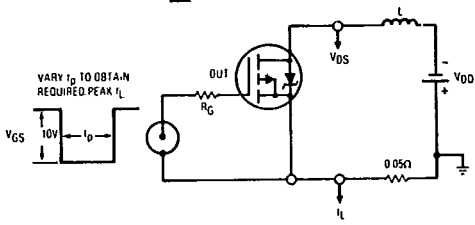

Fig. 14a — Unclamped Inductive Test Circuit

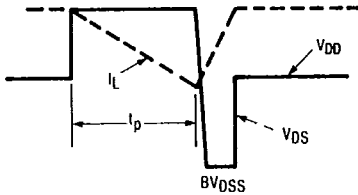

Fig. 14b — Unclamped Inductive Waveforms

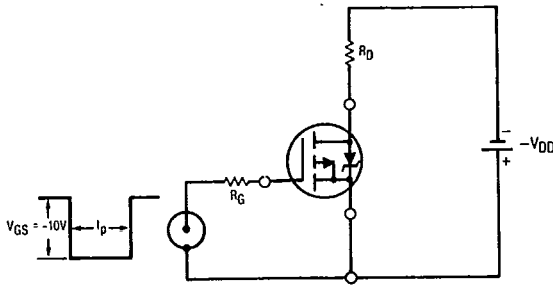

Fig. 15a — Switching Time Test Circuit

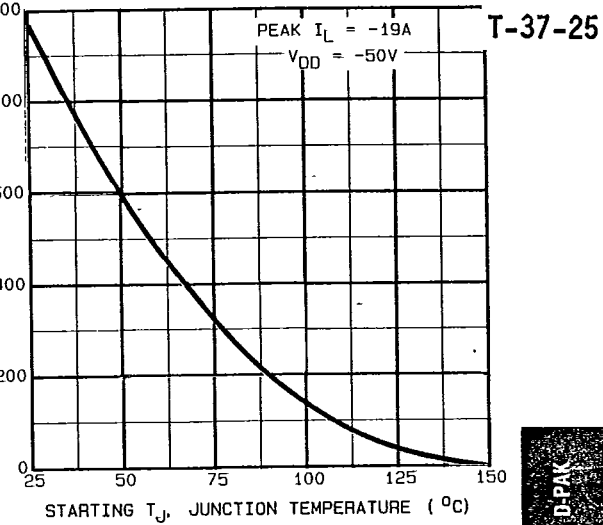

Fig. 14c — Maximum Avalanche Vs. Starting Junction Temperature

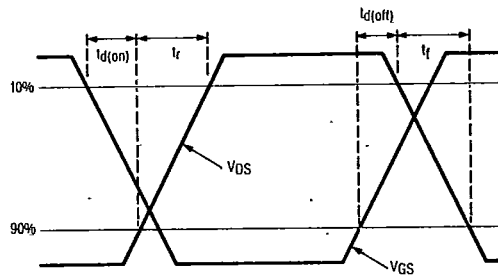

Fig. 15b — Switching Time Waveforms

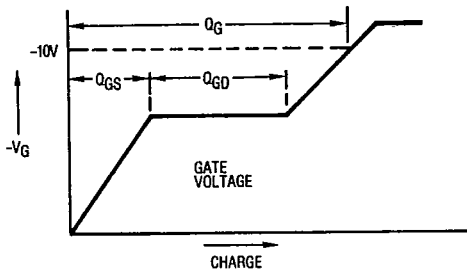

Fig. 16a — Basic Gate Charge Waveform

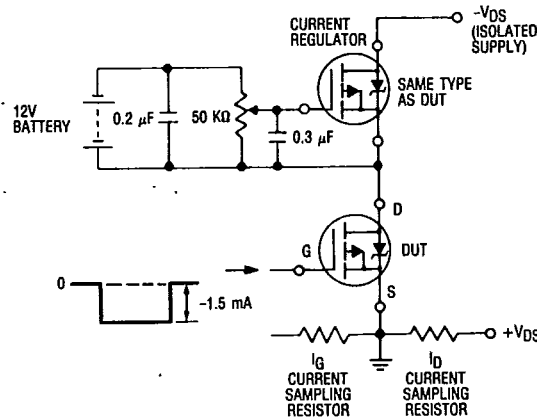

Fig. 16b — Gate Charge Test Circuit

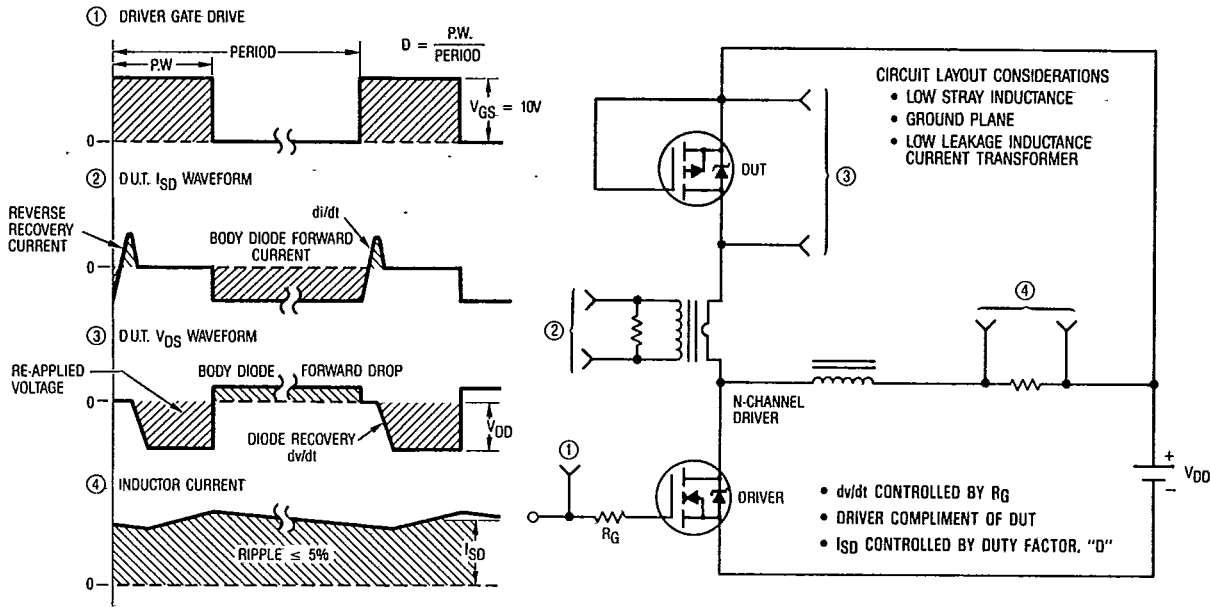

Fig. 17 — Peak Diode Recovery dv/dt Test Circuit

ORDERING INFORMATION

IRFR Series — Tape and reel
 when ordering, add TR after the part number
 and the quantity
 (order in multiples of 3,000 pieces).

Example: IRFR9020TR — 15,000 pieces.

PACKAGING

