

IRG4PSC71KD

INSULATED GATE BIPOLAR TRANSISTOR WITH
ULTRAFAST SOFT RECOVERY DIODE

Short Circuit Rated
UltraFast IGBT

Features

- Hole-less clip/pressure mount package compatible with TO-247 and TO-264, with reinforced pins
- High abort circuit rating IGBTs, optimized for motorcontrol
- Minimum switching losses combined with low conduction losses
- Tightest parameter distribution
- IGBT co-packaged with ultrafast soft recovery antiparallel diode
- Creepage distance increased to 5.35mm

Benefits

- Highest current rating copack IGBT
- Maximum power density, twice the power handling of the TO-247, less space than TO-264
- HEXFRED™ diode optimized for operation with IGBT, to minimize EMI, noise and switching losses

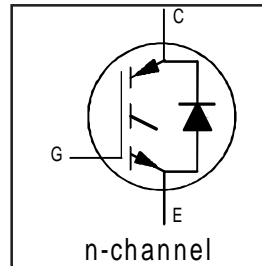

$V_{CES} = 600V$
$V_{CE(on)} \text{ typ.} = 1.83V$
@ $V_{GE} = 15V, I_C = 60A$

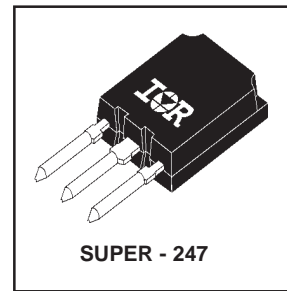

Absolute Maximum Ratings

	Parameter	Max.	Units
V_{CES}	Collector-to-Emitter Voltage	600	V
$I_C @ T_C = 25^\circ C$	Continuous Collector Current	85 ⑤	A
$I_C @ T_C = 100^\circ C$	Continuous Collector Current	60	
I_{CM}	Pulsed Collector Current ①	200	
I_{LM}	Clamped Inductive Load Current ②	200	
$I_F @ T_C = 100^\circ C$	Diode Continuous Forward Current	50	
I_{FM}	Diode Maximum Forward Current	200	
t_{sc}	Short Circuit Withstand Time	10	μs
V_{GE}	Gate-to-Emitter Voltage	± 20	V
$P_D @ T_C = 25^\circ C$	Maximum Power Dissipation	350	W
$P_D @ T_C = 100^\circ C$	Maximum Power Dissipation	140	
T_J	Operating Junction and	-55 to +150	$^\circ C$
T_{STG}	Storage Temperature Range		
	Soldering Temperature, for 10 sec.	300 (0.063 in. (1.6mm) from case)	

Thermal Resistance\ Mechanical

	Parameter	Min.	Typ.	Max.	Units
$R_{\theta JC}$	Junction-to-Case - IGBT	—	—	0.36	$^\circ C/W$
$R_{\theta JC}$	Junction-to-Case - Diode	—	—	0.69	
$R_{\theta CS}$	Case-to-Sink, flat, greased surface	—	0.24	—	
$R_{\theta JA}$	Junction-to-Ambient, typical socket mount	—	—	38	
	Recommended Clip Force	20.0(2.0)	—	—	N (kgf)
	Weight	—	6 (0.21)	—	g (oz)

Electrical Characteristics @ T_J = 25°C (unless otherwise specified)

	Parameter	Min.	Typ.	Max.	Units	Conditions
V _{(BR)CES}	Collector-to-Emitter Breakdown Voltage ^③	600	—	—	V	V _{GE} = 0V, I _C = 250μA
ΔV _{(BR)CES/ΔT_J}	Temperature Coeff. of Breakdown Voltage	—	0.5	—	V/°C	V _{GE} = 0V, I _C = 10mA
V _{CE(on)}	Collector-to-Emitter Saturation Voltage	—	1.83	2.3	V	I _C = 60A V _{GE} = 15V
		—	2.20	—		I _C = 100A See Fig. 2, 5
		—	1.81	—		I _C = 60A, T _J = 150°C
V _{GE(th)}	Gate Threshold Voltage	3.0	—	6.0		V _{CE} = V _{GE} , I _C = 250μA
ΔV _{GE(th)/ΔT_J}	Temperature Coeff. of Threshold Voltage	—	-8.0	—	mV/°C	V _{CE} = V _{GE} , I _C = 1.5mA
g _{fe}	Forward Transconductance ^④	31	46	—	S	V _{CE} = 50V, I _C = 60A
I _{CES}	Zero Gate Voltage Collector Current	—	—	500	μA	V _{GE} = 0V, V _{CE} = 600V
		—	—	13	mA	V _{GE} = 0V, V _{CE} = 600V, T _J = 150°C
V _{FM}	Diode Forward Voltage Drop	—	1.4	1.7	V	I _C = 60A See Fig. 13
		—	1.3	—		I _C = 60A, T _J = 150°C
I _{GES}	Gate-to-Emitter Leakage Current	—	—	±100	nA	V _{GE} = ±20V

Switching Characteristics @ T_J = 25°C (unless otherwise specified)

	Parameter	Min.	Typ.	Max.	Units	Conditions
Q _g	Total Gate Charge (turn-on)	—	340	510	nC	I _C = 60A
Q _{ge}	Gate - Emitter Charge (turn-on)	—	44	66		V _{CC} = 400V See Fig.8
Q _{gc}	Gate - Collector Charge (turn-on)	—	160	240		V _{GE} = 15V
t _{d(on)}	Turn-On Delay Time	—	82	—	ns	T _J = 25°C
t _r	Rise Time	—	107	—		I _C = 60A, V _{CC} = 480V
t _{d(off)}	Turn-Off Delay Time	—	282	423		V _{GE} = 15V, R _G = 5.0Ω
t _f	Fall Time	—	97	146		Energy losses include "tail" and diode reverse recovery
E _{on}	Turn-On Switching Loss	—	3.95	—	mJ	See Fig. 9,10,18
E _{off}	Turn-Off Switching Loss	—	2.33	—		
E _{ts}	Total Switching Loss	—	6.28	7.7		
t _{sc}	Short Circuit Withstand Time	10	—	—	μs	V _{CC} = 360V, T _J = 125°C V _{GE} = 15V, R _G = 5.0Ω, V _{CPK} < 500V
t _{d(on)}	Turn-On Delay Time	—	87	—	ns	T _J = 150°C, See Fig. 11,18
t _r	Rise Time	—	104	—		I _C = 60A, V _{CC} = 480V
t _{d(off)}	Turn-Off Delay Time	—	374	—		V _{GE} = 15V, R _G = 5.0Ω
t _f	Fall Time	—	143	—		Energy losses include "tail" and diode reverse recovery
E _{ts}	Total Switching Loss	—	8.5	—	mJ	
L _E	Internal Emitter Inductance	—	13	—	nH	Measured 5mm from package
C _{ies}	Input Capacitance	—	6900	—	pF	V _{GE} = 0V
C _{oes}	Output Capacitance	—	730	—		V _{CC} = 30V See Fig. 7
C _{res}	Reverse Transfer Capacitance	—	190	—		f = 1.0MHz
t _{rr}	Diode Reverse Recovery Time	—	82	120	ns	T _J = 25°C See Fig. 14
		—	140	210		T _J = 125°C
I _{rr}	Diode Peak Reverse Recovery Current	—	8.2	12	A	T _J = 25°C See Fig. 15
		—	13	20		T _J = 125°C
Q _{rr}	Diode Reverse Recovery Charge	—	364	546	nC	T _J = 25°C See Fig. 16
		—	1084	1625		T _J = 125°C
di _{(rec)M/dt}	Diode Peak Rate of Fall of Recovery During t _b	—	328	—	A/μs	T _J = 25°C See Fig. 17
		—	266	—		T _J = 125°C

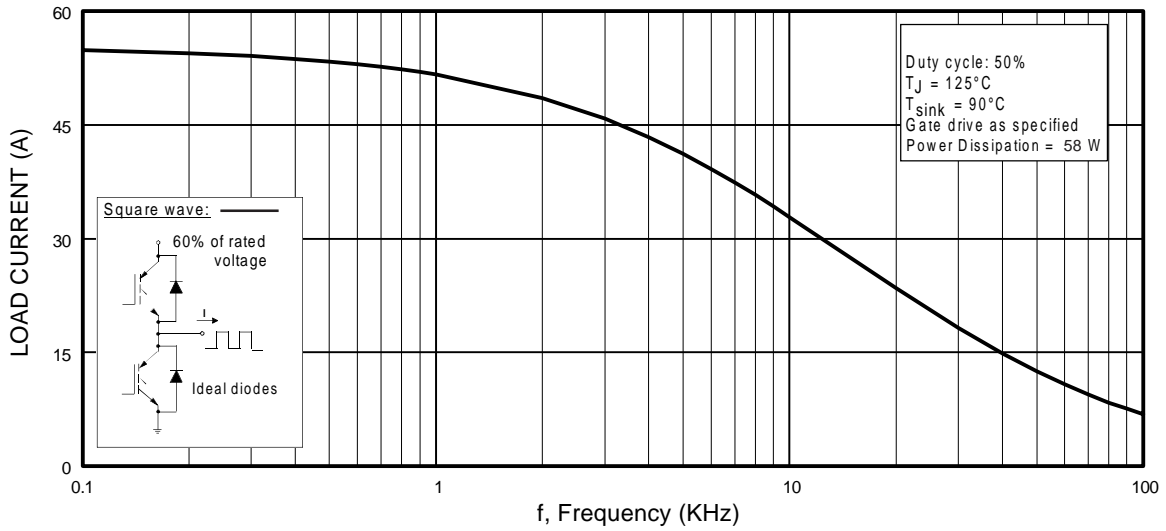

Fig. 1 - Typical Load Current vs. Frequency
 (Load Current = I_{RMS} of fundamental)

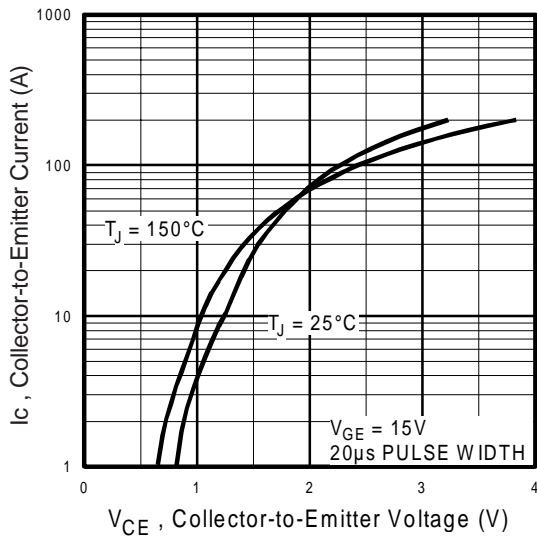

Fig. 2 - Typical Output Characteristics

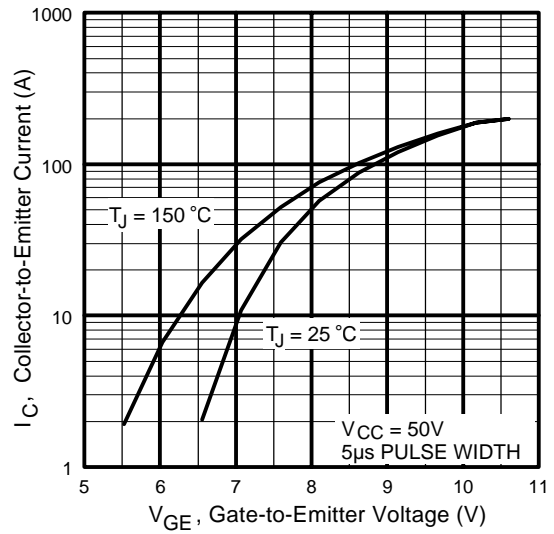

Fig. 3 - Typical Transfer Characteristics

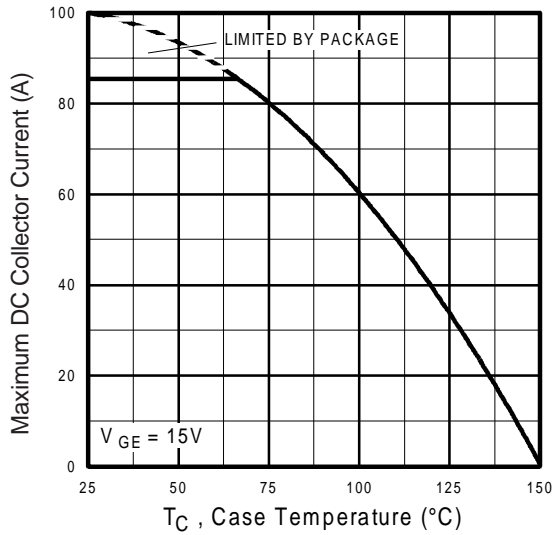

Fig. 4 - Maximum Collector Current vs. Case Temperature

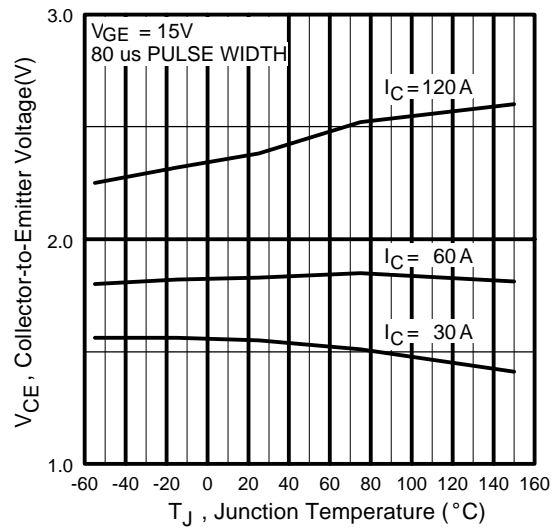

Fig. 5 - Typical Collector-to-Emitter Voltage vs. Junction Temperature

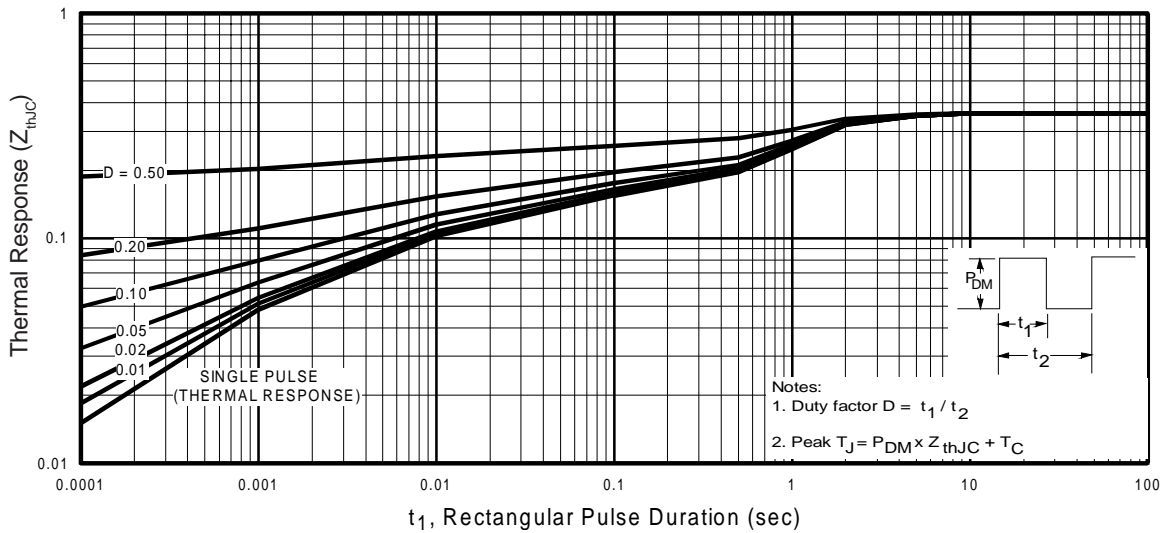

Fig. 6 - Maximum Effective Transient Thermal Impedance, Junction-to-Case

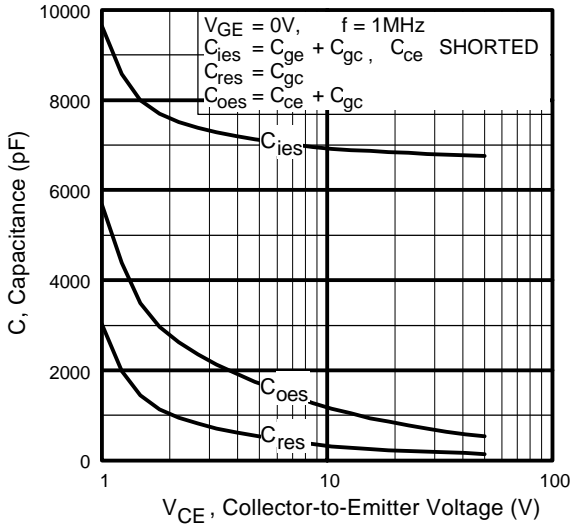

Fig. 7 - Typical Capacitance vs. Collector-to-Emitter Voltage

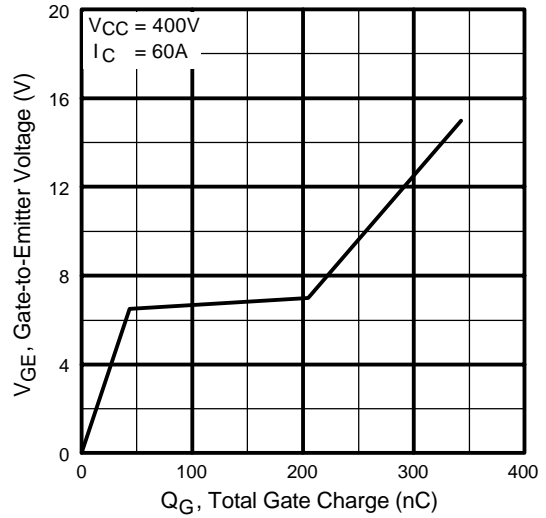

Fig. 8 - Typical Gate Charge vs. Gate-to-Emitter Voltage

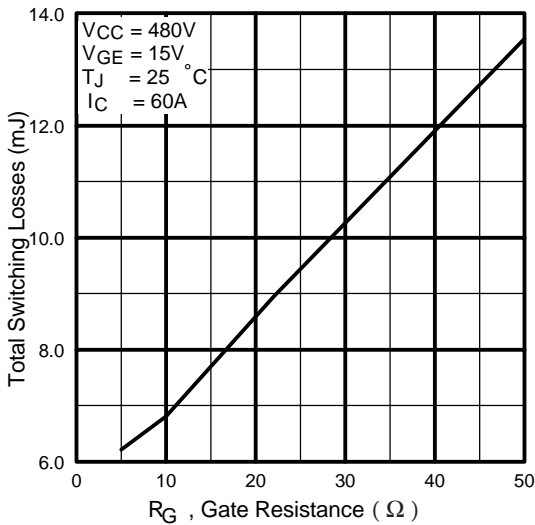

Fig. 9 - Typical Switching Losses vs. Gate Resistance

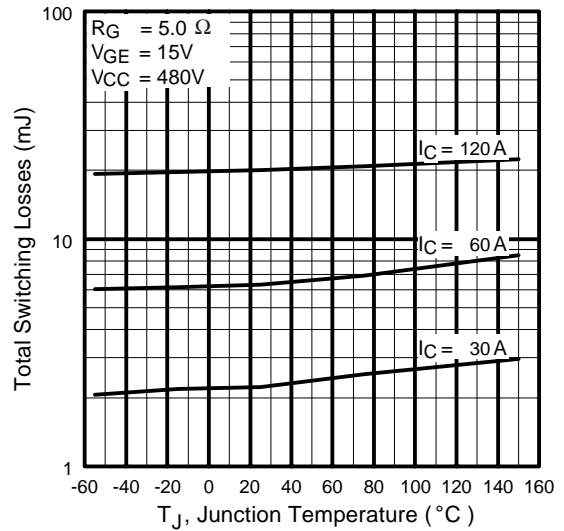

Fig. 10 - Typical Switching Losses vs. Junction Temperature

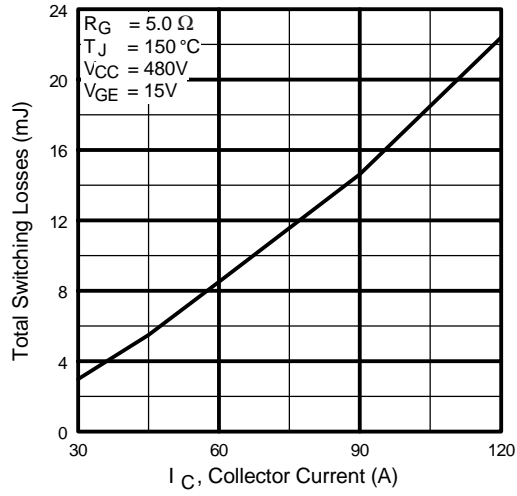

Fig. 11 - Typical Switching Losses vs. Collector-to-Emitter Current

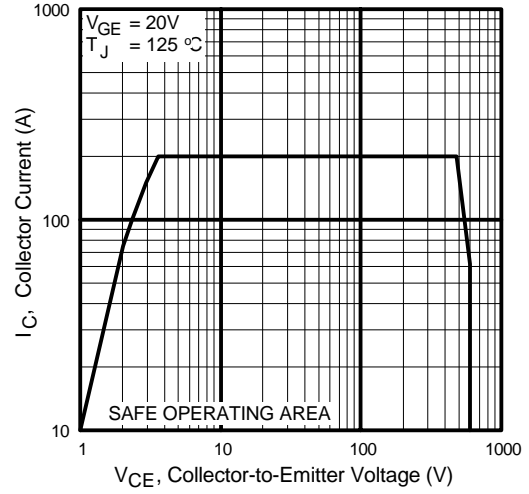

Fig. 12 - Turn-Off SOA

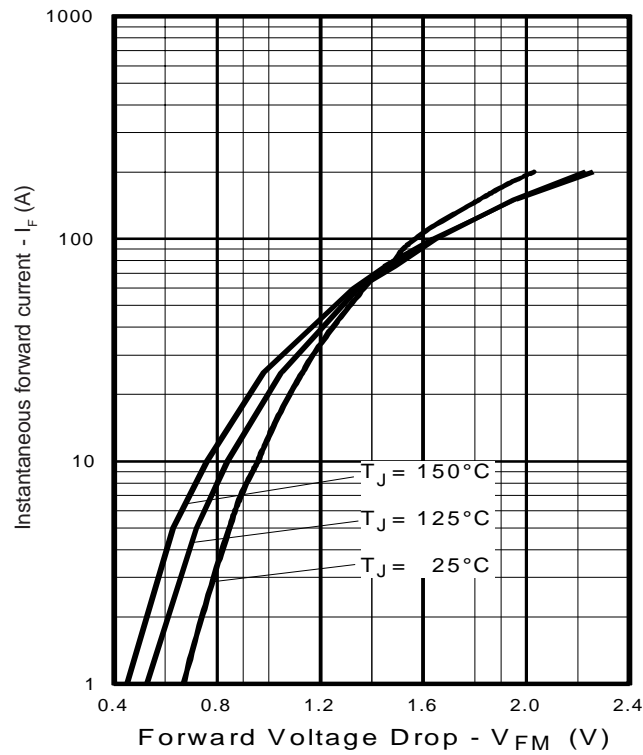

Fig. 13 - Maximum Forward Voltage Drop vs. Instantaneous Forward Current

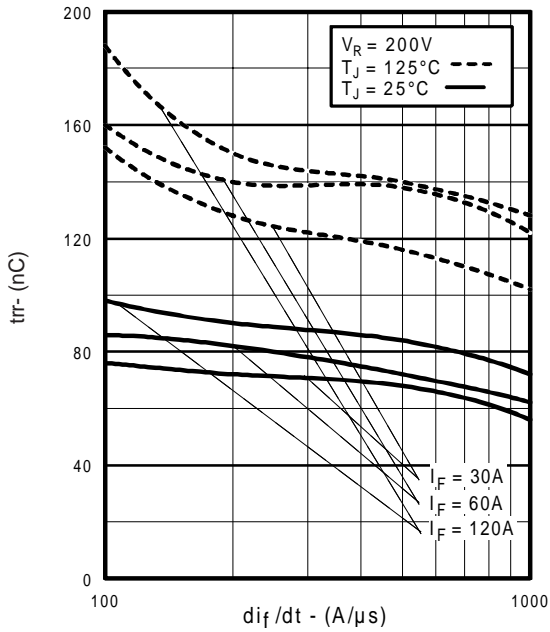

Fig. 14 - Typical Reverse Recovery vs. di_f/dt

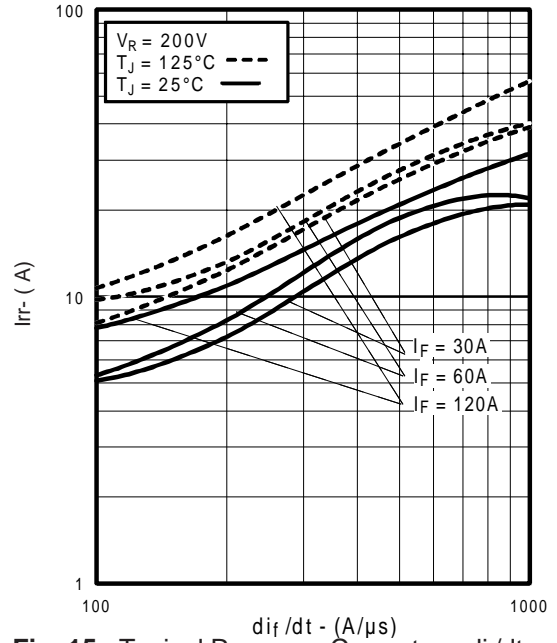

Fig. 15 - Typical Recovery Current vs. di_f/dt

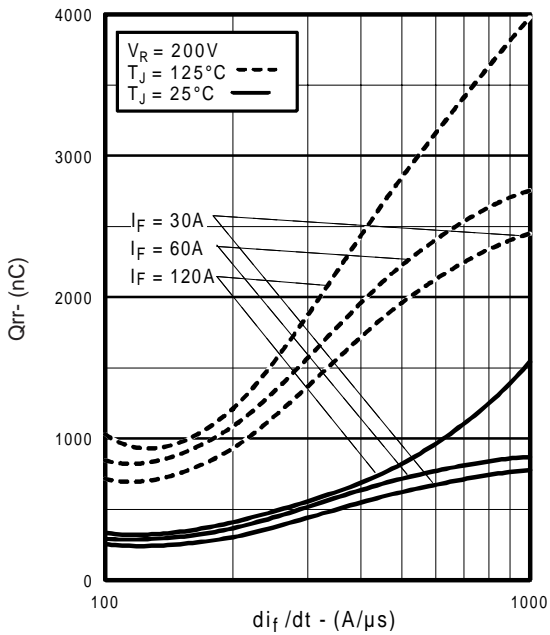

Fig. 16 - Typical Stored Charge vs. di_f/dt
www.irf.com

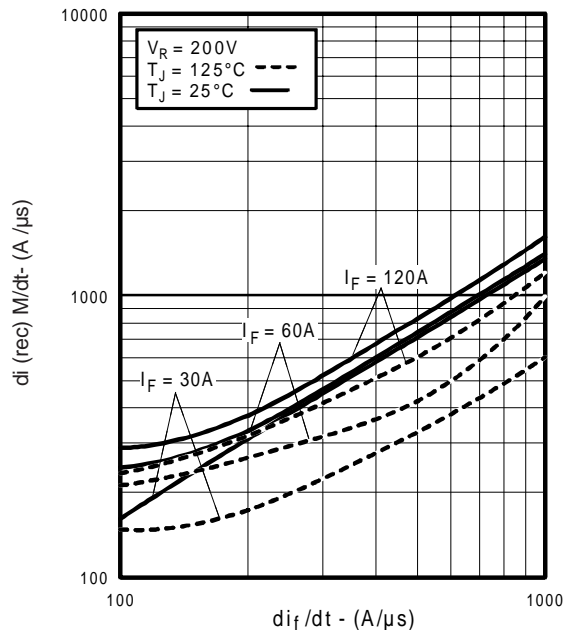

Fig. 17 - Typical $di_{(rec)M}/dt$ vs. di_f/dt

IRG4PSC71KD

International
IRF Rectifier

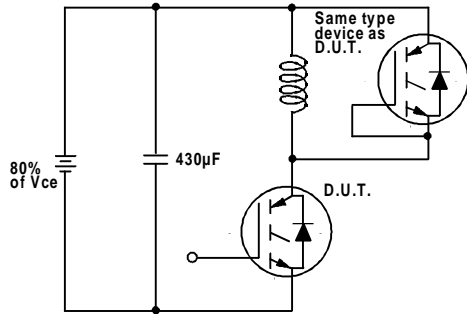

Fig. 18a - Test Circuit for Measurement of I_{LM} , E_{on} , $E_{off}(\text{diode})$, t_{rr} , Q_{rr} , I_{rr} , $t_{d(on)}$, t_r , $t_{d(off)}$, t_f

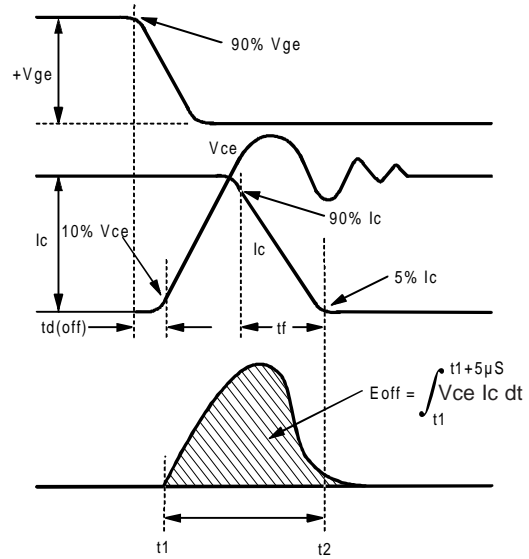

Fig. 18b - Test Waveforms for Circuit of Fig. 18a, Defining E_{off} , $t_{d(off)}$, t_f

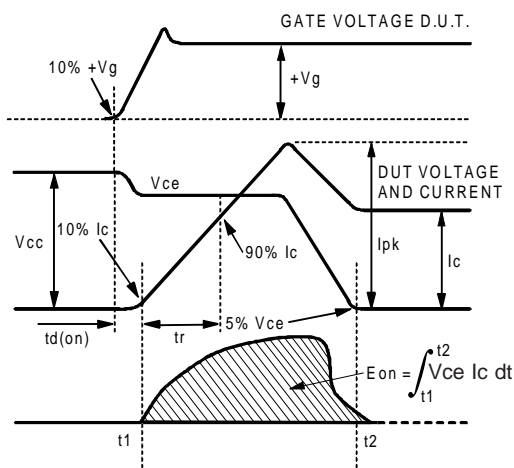

Fig. 18c - Test Waveforms for Circuit of Fig. 18a, Defining E_{on} , $t_{d(on)}$, t_r

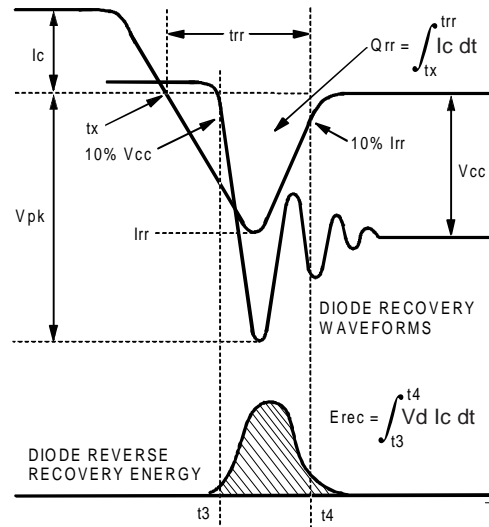

Fig. 18d - Test Waveforms for Circuit of Fig. 18a, Defining E_{rec} , t_{rr} , Q_{rr} , I_{rr}

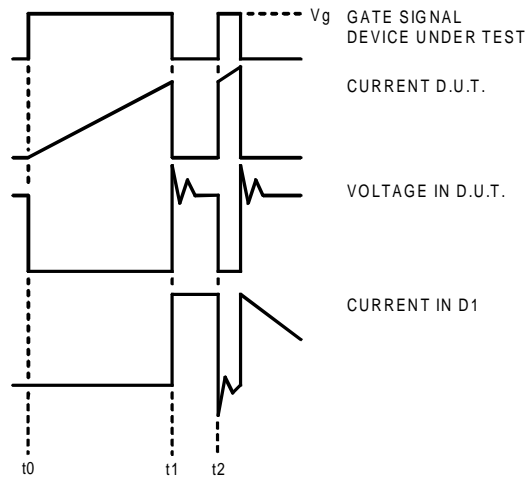

Figure 18e. Macro Waveforms for Figure 18a's Test Circuit

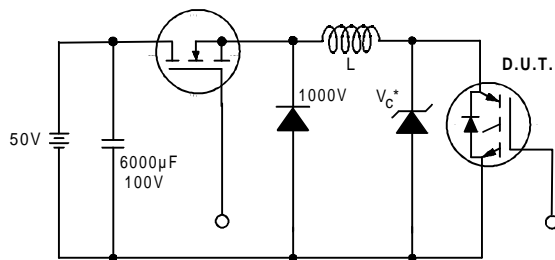

Figure 19. Clamped Inductive Load Test Circuit

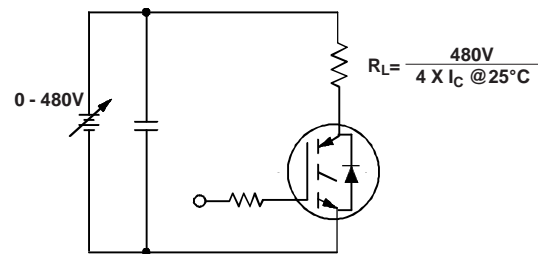

Figure 20. Pulsed Collector Current Test Circuit

IRG4PSC71KD

International
IR Rectifier

Notes:

- ① Repetitive rating: $V_{GE}=20V$; pulse width limited by maximum junction temperature (figure 20)
- ② $V_{CC}=80\%(V_{CES})$, $V_{GE}=20V$, $L=10\mu H$, $R_G= 5.0\Omega$ (figure 19)
- ③ Pulse width $\leq 80\mu s$; duty factor $\leq 0.1\%$
- ④ Pulse width $5.0\mu s$, single shot
- ⑤ Current limited by the package, (Die current = 100A)

Case Outline and Dimensions — Super-247

Dimensions are shown in millimeters

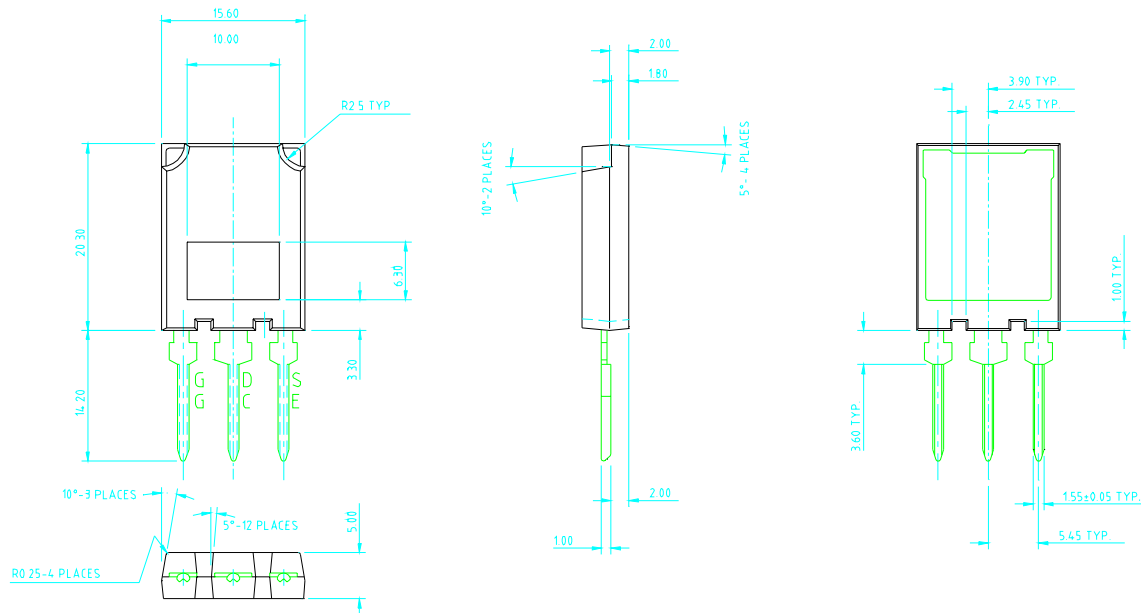

International
IR Rectifier

WORLD HEADQUARTERS: 233 Kansas St., El Segundo, California 90245, Tel: (310) 322 3331

IR GREAT BRITAIN: Hurst Green, Oxted, Surrey RH8 9BB, UK Tel: ++ 44 1883 732020

IR CANADA: 15 Lincoln Court, Brampton, Ontario L6T3Z2, Tel: (905) 453 2200

IR GERMANY: Saalburgstrasse 157, 61350 Bad Homburg Tel: ++ 49 6172 96590

IR ITALY: Via Liguria 49, 10071 Borgaro, Torino Tel: ++ 39 11 451 0111

IR FAR EAST: K&H Bldg., 2F, 30-4 Nishi-Ikebukuro 3-Chome, Toshima-Ku, Tokyo Japan 171 Tel: 81 3 3983 0086

IR SOUTHEAST ASIA: 1 Kim Seng Promenade, Great World City West Tower, 13-11, Singapore 237994 Tel: ++ 65 838 4630

IR TAIWAN: 16 Fl. Suite D. 207, Sec. 2, Tun Haw South Road, Taipei, 10673, Taiwan Tel: 886-2-2377-9936

<http://www.irf.com/>

Data and specifications subject to change without notice.

5/99