

IRG4PSH71UD

INSULATED GATE BIPOLAR TRANSISTOR WITH
 ULTRAFAST SOFT RECOVERY DIODE

UltraFast Copack IGBT

Features

- UltraFast switching speed optimized for operating frequencies 8 to 40kHz in hard switching, 200kHz in resonant mode soft switching
- Generation 4 IGBT design provides tighter parameter distribution and higher efficiency (minimum switching and conduction losses) than prior generations
- Industry-benchmark Super-247 package with higher power handling capability compared to same footprint TO-247
- Creepage distance increased to 5.35mm

Benefits

- Generation 4 IGBT's offer highest efficiencies available
- Maximum power density, twice the power handling of the TO-247, less space than TO-264
- IGBTs optimized for specific application conditions
- Cost and space saving in designs that require multiple, paralleled IGBTs
- HEXFRED™ antiparallel Diode minimizes switching losses and EMI

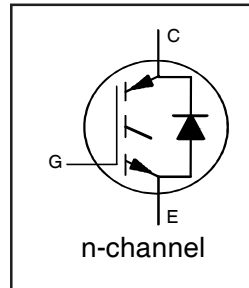

$V_{CES} = 1200V$
$V_{CE(on) typ.} = 2.52V$
@ $V_{GE} = 15V, I_C = 50A$

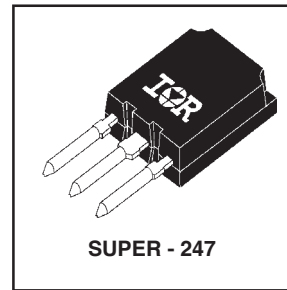

Absolute Maximum Ratings

	Parameter	Max.	Units
V_{CES}	Collector-to-Emitter Voltage	1200	V
$I_C @ T_C = 25^\circ C$	Continuous Collector Current	99	A
$I_C @ T_C = 100^\circ C$	Continuous Collector Current	50	
I_{CM}	Pulse Collector Current ①	200	
I_{LM}	Clamped Inductive Load current ②	200	
V_{GE}	Gate-to-Emitter Voltage	± 20	
$I_F @ T_C = 100^\circ C$	Diode Continuous Forward Current	70	W
I_{FM}	Diode Maximum Forward Current	200	
$P_D @ T_C = 25^\circ C$	Maximum Power Dissipation	350	
$P_D @ T_C = 100^\circ C$	Maximum Power Dissipation	140	
T_J	Operating Junction and	-55 to +150	°C
T_{STG}	Storage Temperature Range		
	Storage Temperature Range, for 10 sec.	300 (0.063 in. (1.6mm) from case)	

Thermal / Mechanical Characteristics

	Parameter	Min.	Typ.	Max.	Units
$R_{\theta JC}$	Junction-to-Case- IGBT	—	—	0.36	°C/W
$R_{\theta JC}$	Junction-to-Case- Diode	—	—	0.36	
$R_{\theta CS}$	Case-to-Sink, flat, greased surface	—	0.24	—	
$R_{\theta JA}$	Junction-to-Ambient, typical socket mount	—	—	38	
	Recommended Clip Force	20 (2.0)			N (kgf)
Wt	Weight	—	6 (0.21)	—	g (oz.)

IRG4PSH71UD

International
IR Rectifier

Electrical Characteristics @ T_J = 25°C (unless otherwise specified)

Parameter	Min.	Typ.	Max.	Units	Conditions	
V _{(BR)CES}	1200	—	—	V	V _{GE} = 0V, I _C = 250μA	
V _{(BR)ECS}	19	—	—	V	V _{GE} = 0V, I _C = 1.0A	
ΔV _{(BR)CES} /ΔT _J	—	0.78	—	V/°C	V _{GE} = 0V, I _C = 1mA	
V _{CE(on)}	Collector-to-Emitter Saturation Voltage	—	2.52	2.70	V	I _C = 70A, V _{GE} = 15V I _C = 140A, T _J = 150°C See Fig.2, 5
		—	3.17	—		
		—	2.68	—		
V _{GE(th)}	3.0	—	6.0		V _{CE} = V _{GE} , I _C = 250μA	
ΔV _{GE(th)} /ΔT _J	—	-9.2	—	mV/°C	V _{CE} = V _{GE} , I _C = 1.0mA	
g _f	48	72	—	S	V _{CE} = 100V, I _C = 70A	
I _{CES}	Zero Gate Voltage Collector Current	—	—	500	μA	V _{GE} = 0V, V _{CE} = 1200V V _{GE} = 0V, V _{CE} = 10V V _{GE} = 0V, V _{CE} = 1200V, T _J = 150°C
		—	—	2.0		
		—	—	5000		
V _{FM}	Diode Forward Voltage Drop	—	2.92	3.9	V	I _F = 70A, T _J = 150°C See Fig.13
		—	2.88	3.7		
I _{GES}	Gate-to-Emitter Leakage Current	—	—	±100	nA	V _{GE} = ±20V

Switching Characteristics @ T_J = 25°C (unless otherwise specified)

Parameter	Min.	Typ.	Max.	Units	Conditions	
Q _g	—	380	570	nC	I _C = 70A V _{CC} = 400V, V _{GE} = 15V See Fig.8	
Q _{ge}	—	61	24			
Q _{gc}	—	130	200			
t _{d(on)}	—	46	—	ns	I _C = 70A, V _{CC} = 960V V _{GE} = 15V, R _G = 5.0Ω Energy losses include "tail" See Fig. 9, 10, 11, 14	
t _r	—	77	—			
t _{d(off)}	—	250	350			
t _f	—	220	330			
E _{on}	—	8.8	—			
E _{off}	—	9.4	—	mJ	T _J = 150°C, See Fig. 9, 10, 11, 14 I _C = 70A, V _{CC} = 960V V _{GE} = 15V, R _G = 5.0Ω Energy losses include "tail"	
E _{tot}	—	18.2	19.7			
t _{d(on)}	—	43	—	ns	T _J = 150°C, See Fig. 9, 10, 11, 14 I _C = 70A, V _{CC} = 960V V _{GE} = 15V, R _G = 5.0Ω Energy losses include "tail"	
t _r	—	78	—			
t _{d(off)}	—	330	—			
t _f	—	480	—			
E _{TS}	—	26	—	mJ		
L _E	—	13	—	nH	Measured 5mm from package	
C _{ies}	—	6640	—	pF	V _{GE} = 0V V _{CC} = 30V, f = 1.0MHz See Fig.7	
C _{oes}	—	420	—			
C _{res}	—	60	—			
t _{rr}	Diode Reverse Recovery Time	—	110	170	ns	T _J =25°C, See Fig. 14 T _J =125°C
		—	180	270		
I _{rr}	Diode Peak Reverse Recovery Current	—	6.0	9.0	A	T _J =25°C, See Fig. 15 T _J =125°C
		—	8.9	13		
Q _{rr}	Diode Reverse Recovery Charge	—	350	530	nC	T _J =25°C, See Fig. 16 T _J =125°C
		—	870	1300		
di _{(rec)M} /dt	Diode Peak Rate of Fall of Recovery During t _b	—	150	230	A/μs	T _J =25°C, See Fig. 17 T _J =125°C
		—	130	200		

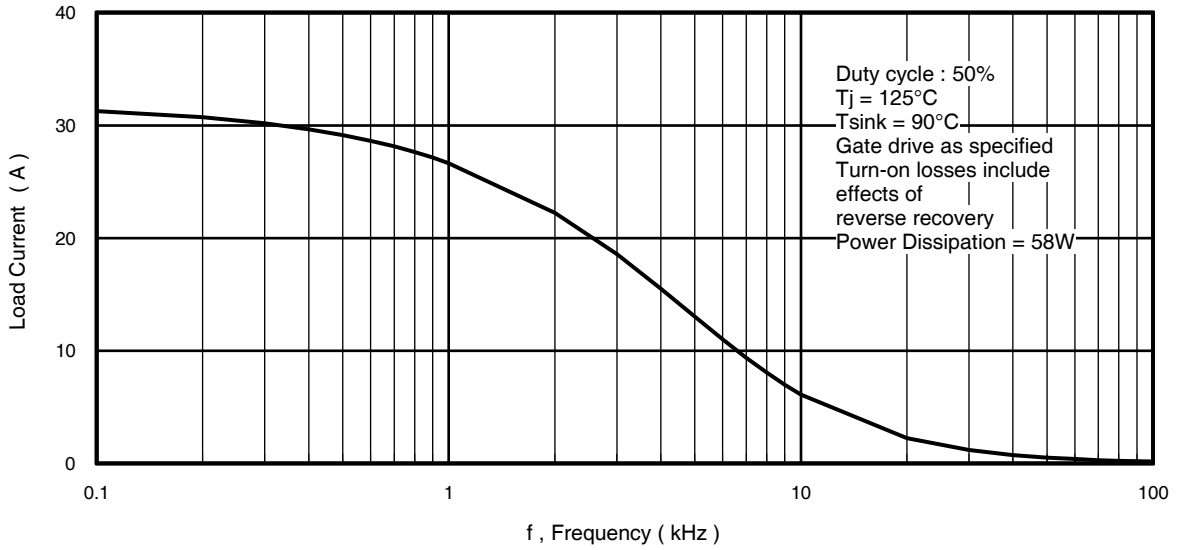

Fig. 1 - Typical Load Current vs. Frequency
 (For square wave, $I = I_{\text{RMS}}$ of fundamental; for triangular wave, $I = I_{\text{PK}}$)

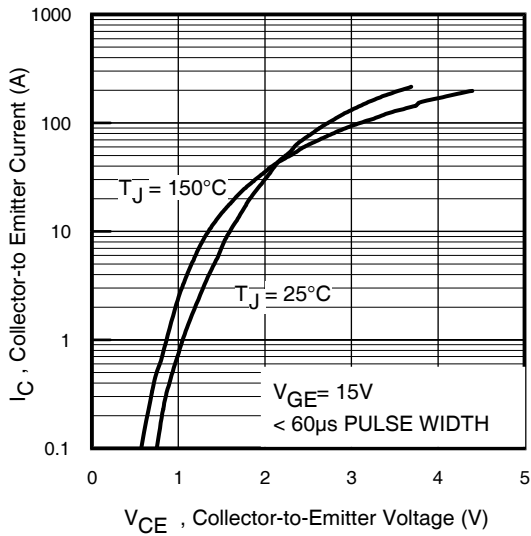

Fig. 2 - Typical Output Characteristics

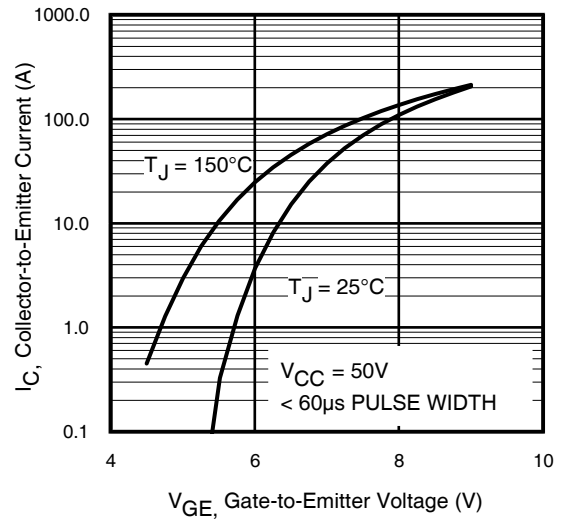

Fig. 3 - Typical Transfer Characteristics

IRG4PSH71UD

International
IR Rectifier

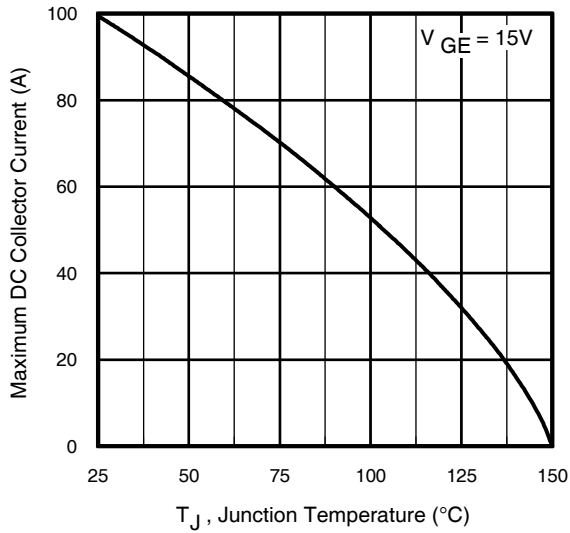

Fig. 4 - Maximum Collector Current vs. Case Temperature

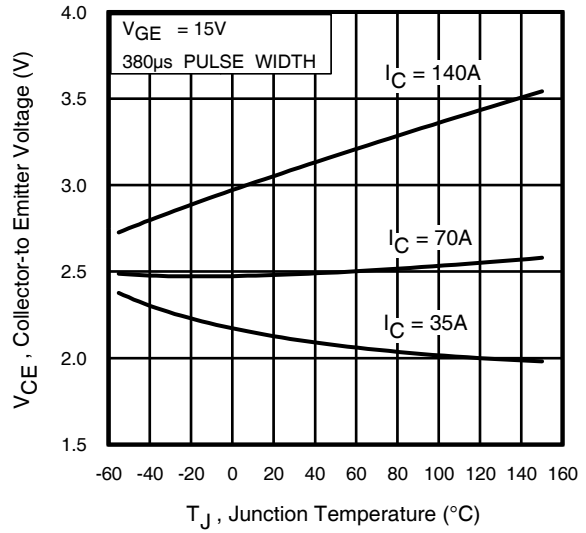

Fig. 5 - Collector-to-Emitter Voltage vs. Junction Temperature

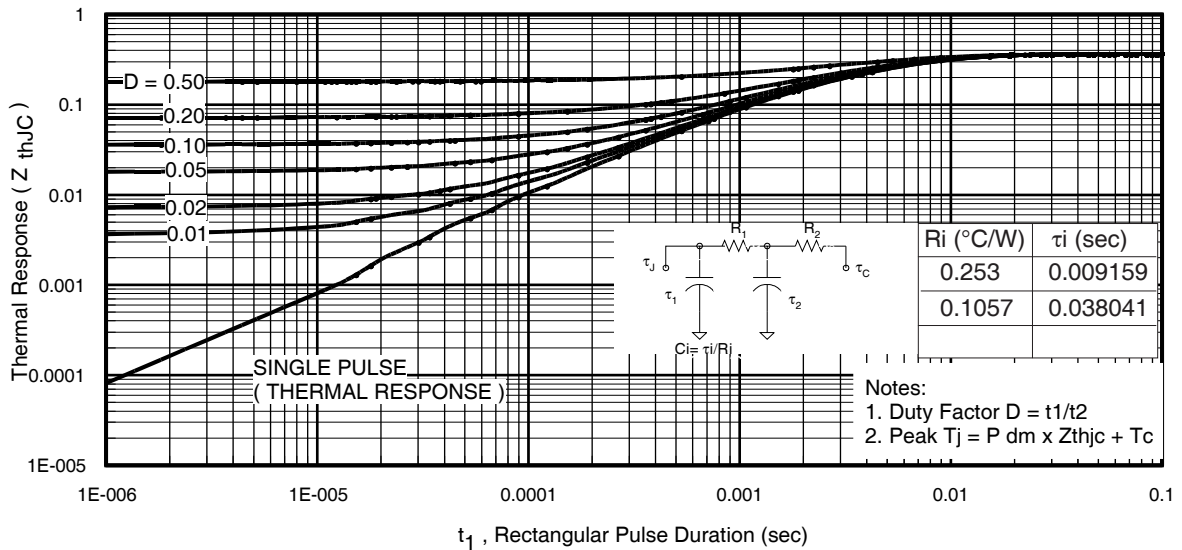

Fig. 6 - Maximum Effective Transient Thermal Impedance, Junction-to-Case

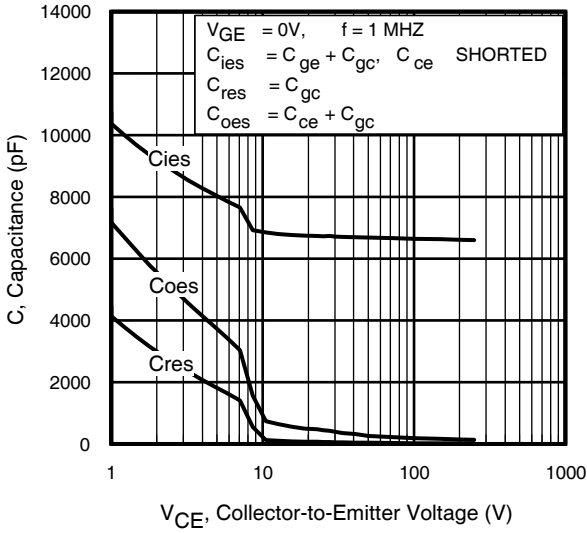

Fig. 7 - Typical Capacitance vs. Collector-to-Emitter Voltage

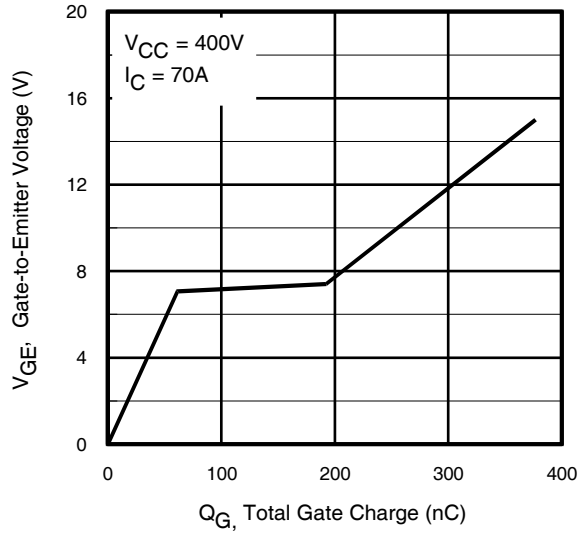

Fig. 8 - Typical Gate Charge vs. Gate-to-Emitter Voltage

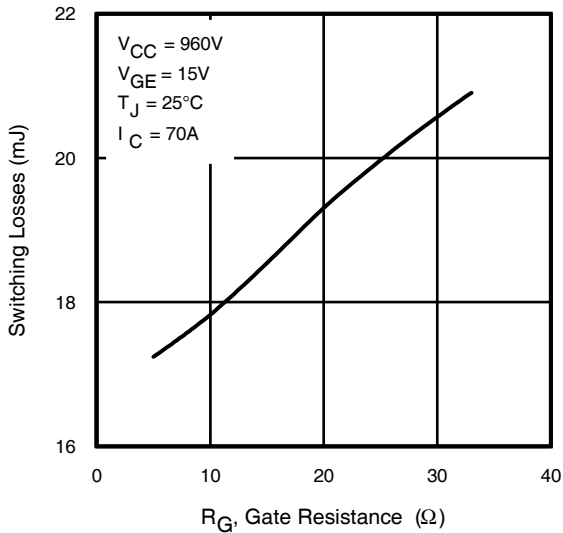

Fig. 9 - Typical Switching Losses vs. Gate Resistance

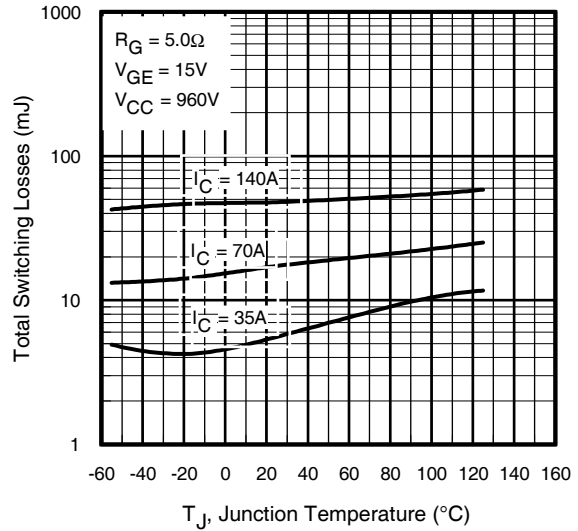

Fig. 10 - Typical Switching Losses vs. Junction Temperature

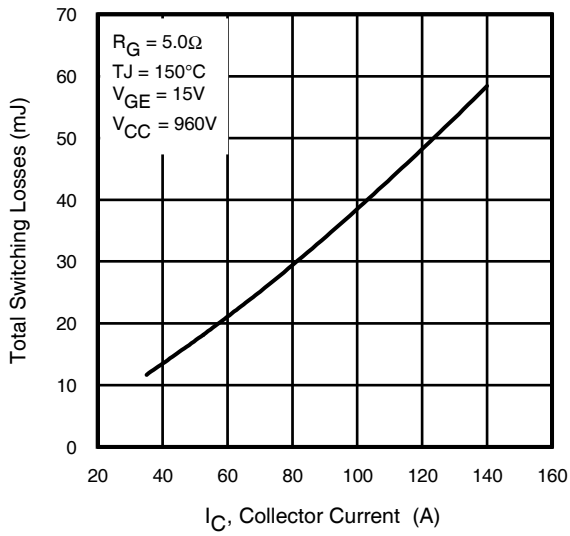

Fig. 11 - Typical Switching Losses vs. Collector-to-Emitter Current

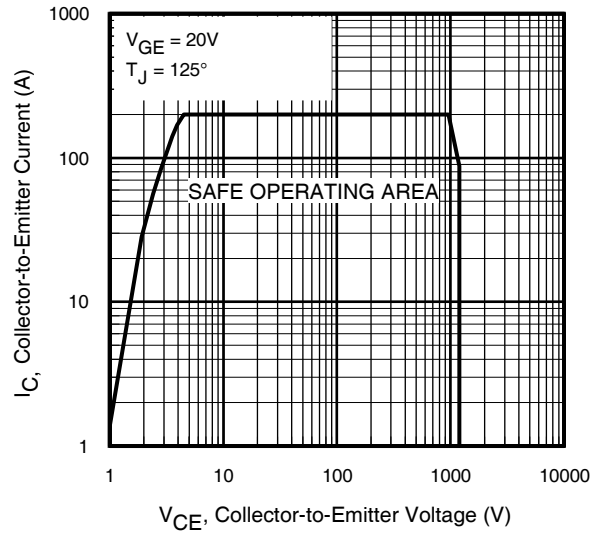

Fig. 12 - Turn-Off SOA

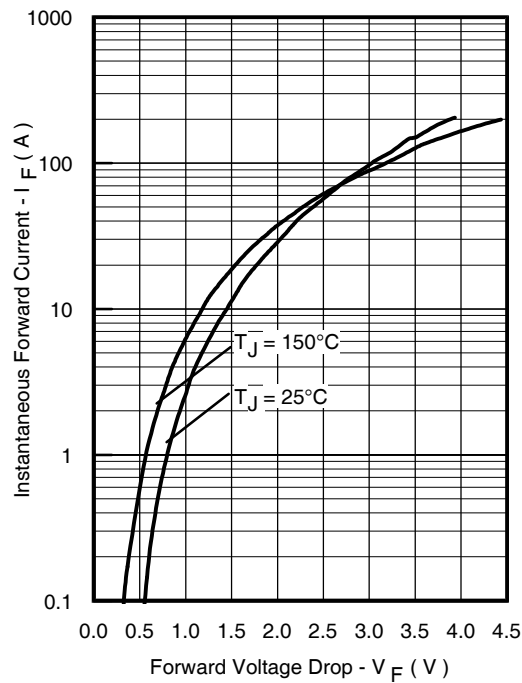

Fig. 13 - Maximum Forward Voltage Drop vs. Instantaneous Forward Current

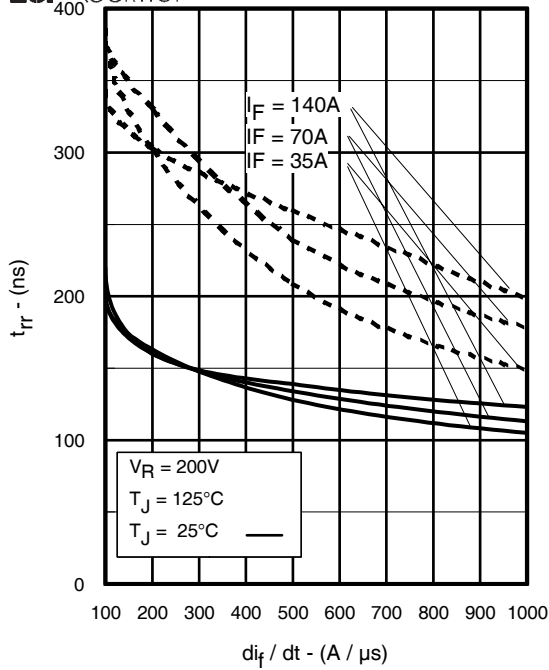

Fig. 14 - Typical Reverse Recovery vs. di_f/dt

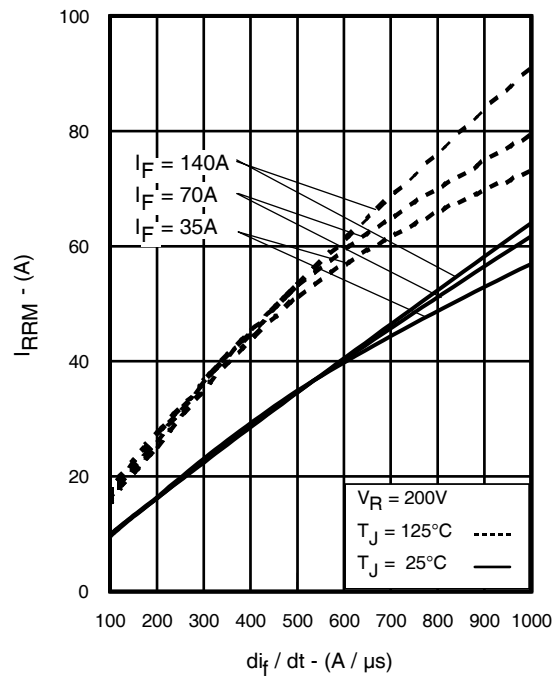

Fig. 15 - Typical Recovery Current vs. di_f/dt

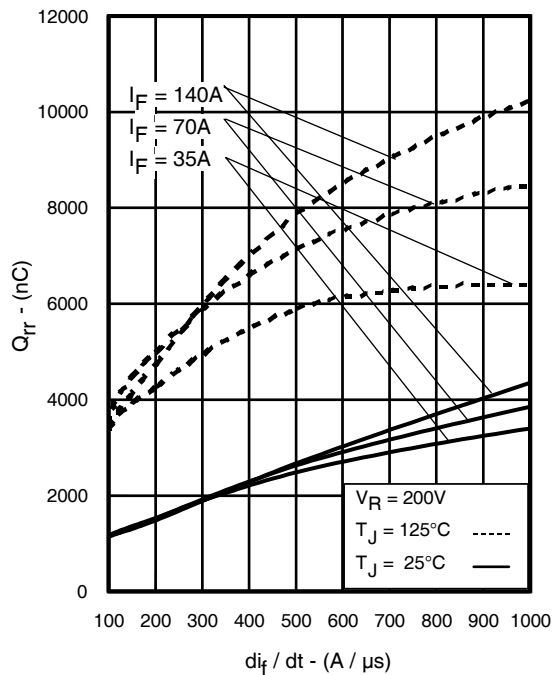

Fig. 16 - Typical Stored Charge vs. di_f/dt
www.irf.com

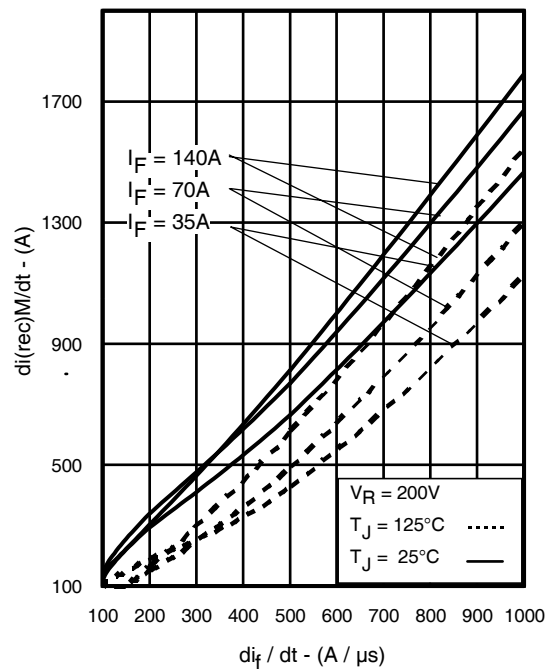

Fig. 17 - Typical $di_{(rec)}M/dt$ vs. di_f/dt

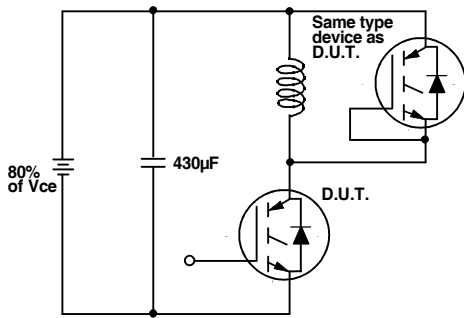

Fig. 18a - Test Circuit for Measurement of I_{LM} , E_{on} , E_{off} (diode), t_{rr} , Q_{rr} , I_{rr} , $t_{d(on)}$, t_r , $t_{d(off)}$, t_f

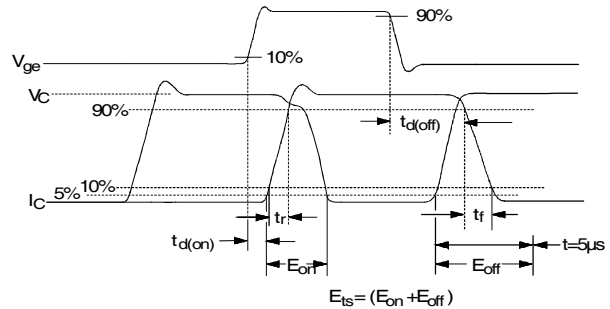

Fig. 18b - Test Waveforms for Circuit of Fig. 18a, Defining E_{off} , $t_{d(off)}$, t_f

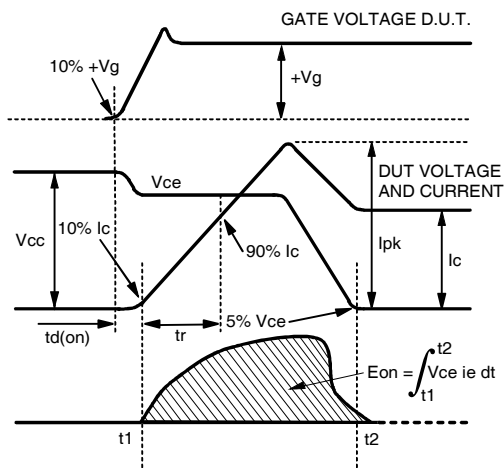

Fig. 18c - Test Waveforms for Circuit of Fig. 18a, Defining E_{on} , $t_{d(on)}$, t_r

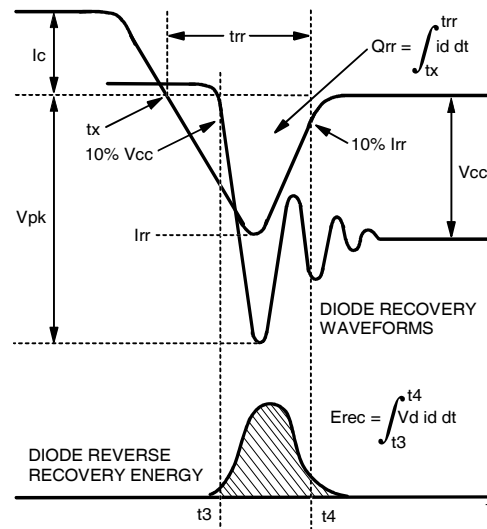

Fig. 18d - Test Waveforms for Circuit of Fig. 18a, Defining E_{rec} , t_{rr} , Q_{rr} , I_{rr}

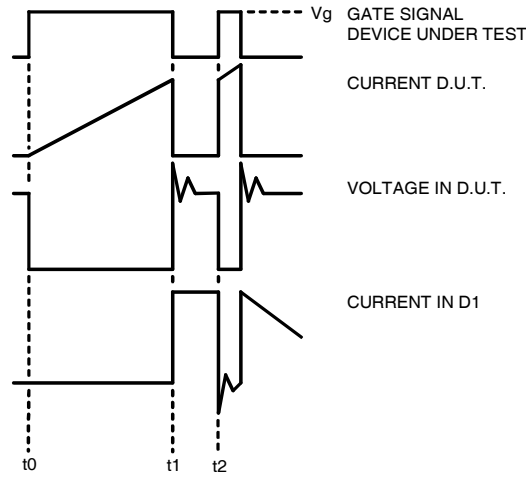

Figure 18e. Macro Waveforms for Figure 18a's Test Circuit

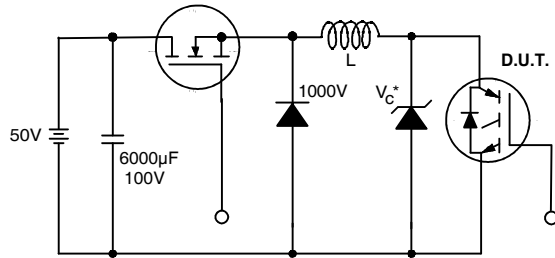

Figure 19. Clamped Inductive Load Test Circuit

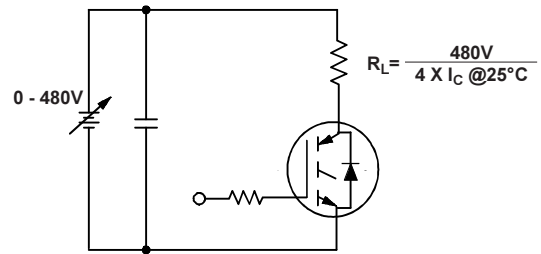
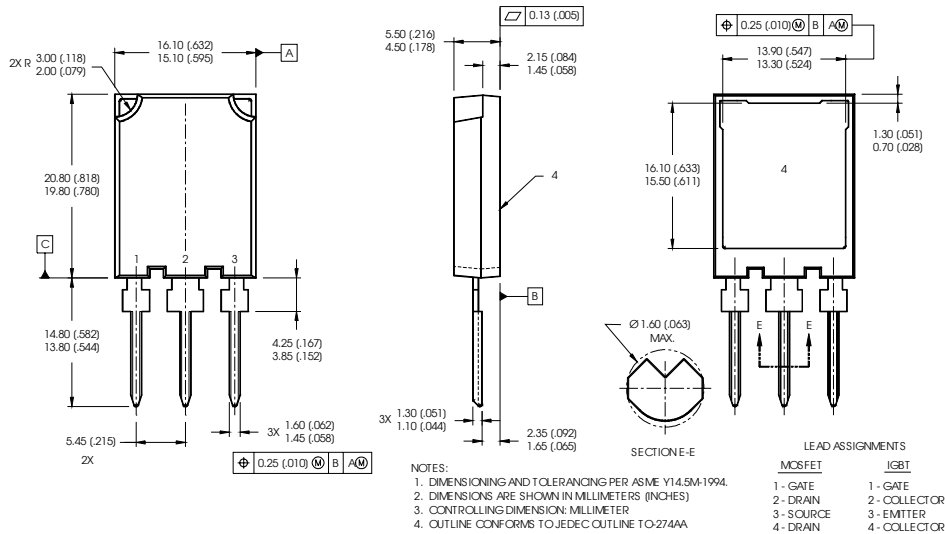

Figure 20. Pulsed Collector Current Test Circuit

IRG4PSH71UD

International
IR Rectifier

Super-247™ (TO-274AA) Package Outline



Super-247™ (TO-274AA) Part Marking Information

EXAMPLE: THIS IS AN IRFPS37N50A WITH ASSEMBLY LOT CODE A8B9

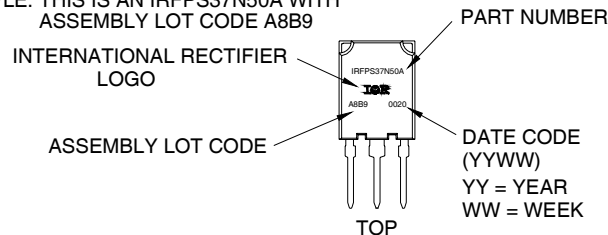

Super TO-247™ package is not recommended for Surface Mount Application.

Notes:

- ① Repetitive rating: $V_{GE}=20V$; pulse width limited by maximum junction temperature (figure 20)
- ② $V_{CC}=80\%(V_{CES})$, $V_{GE}=20V$, $L=10\mu H$, $R_G=5.0\ \Omega$ (figure 13a)
- ③ Pulse width $\leq 80\mu s$; duty factor $\leq 0.1\%$.
- ④ Pulse width $5.0\mu s$, single shot.
- ⑤ Repetitive rating; pulse width limited by maximum junction temperature.

Data and specifications subject to change without notice.
This product has been designed and qualified for the Consumer market.
Qualification Standards can be found on IR's Web site.

International
IR Rectifier

IR WORLD HEADQUARTERS: 233 Kansas St., El Segundo, California 90245, USA Tel: (310) 252-7105
TAC Fax: (310) 252-7903

Visit us at www.irf.com for sales contact information.5/04

www.irf.com