

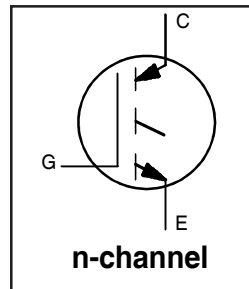
# IRG4PSH71U

INSULATED GATE BIPOLAR TRANSISTOR

UltraFast Speed IGBT

## Features

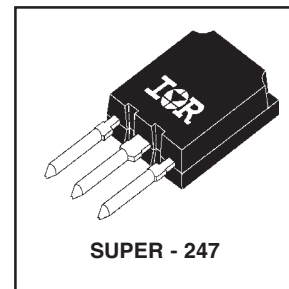
- UltraFast switching speed optimized for operating frequencies 8 to 40kHz in hard switching, 200kHz in resonant mode soft switching
- Generation 4 IGBT design provides tighter parameter distribution and higher efficiency (minimum switching and conduction losses) than prior generations
- Industry-benchmark Super-247 package with higher power handling capability compared to same footprint TO-247
- Creepage distance increased to 5.35mm



$V_{CES} = 1200V$
$V_{CE(on)} \text{ typ.} = 2.50V$
@ $V_{GE} = 15V, I_C = 50A$

## Benefits

- Generation 4 IGBT's offer highest efficiencies available
- Maximum power density, twice the power handling of the TO-247, less space than TO-264
- IGBTs optimized for specific application conditions
- Cost and space saving in designs that require multiple, paralleled IGBTs



## Absolute Maximum Ratings

	Parameter	Max.	Units
$V_{CES}$	Collector-to-Emitter Voltage	1200	V
$I_C @ T_C = 25^\circ C$	Continuous Collector Current	99	A
$I_C @ T_C = 100^\circ C$	Continuous Collector Current	50	
$I_{CM}$	Pulse Collector Current ①	200	
$I_{LM}$	Clamped Inductive Load current ②	200	
$V_{GE}$	Gate-to-Emitter Voltage	$\pm 20$	
$E_{ARV}$	Reverse Voltage Avalanche Energy ③	150	mJ
$P_D @ T_C = 25^\circ C$	Maximum Power Dissipation	350	W
$P_D @ T_C = 100^\circ C$	Maximum Power Dissipation	140	
$T_J$	Operating Junction and	-55 to +150	$^\circ C$
$T_{STG}$	Storage Temperature Range		
	Storage Temperature Range, for 10 sec.	300 (0.063 in. (1.6mm) from case)	

## Thermal / Mechanical Characteristics

	Parameter	Min.	Typ.	Max.	Units
$R_{\theta JC}$	Junction-to-Case- IGBT	—	—	0.36	$^\circ C/W$
$R_{\theta CS}$	Case-to-Sink, flat, greased surface	—	0.24	—	
$R_{\theta JA}$	Junction-to-Ambient, typical socket mount	—	—	38	
	Recommended Clip Force	20 (2.0)			N (kgf)
Wt	Weight	—	6 (0.21)	—	g (oz.)

## Electrical Characteristics @ T<sub>J</sub> = 25°C (unless otherwise specified)

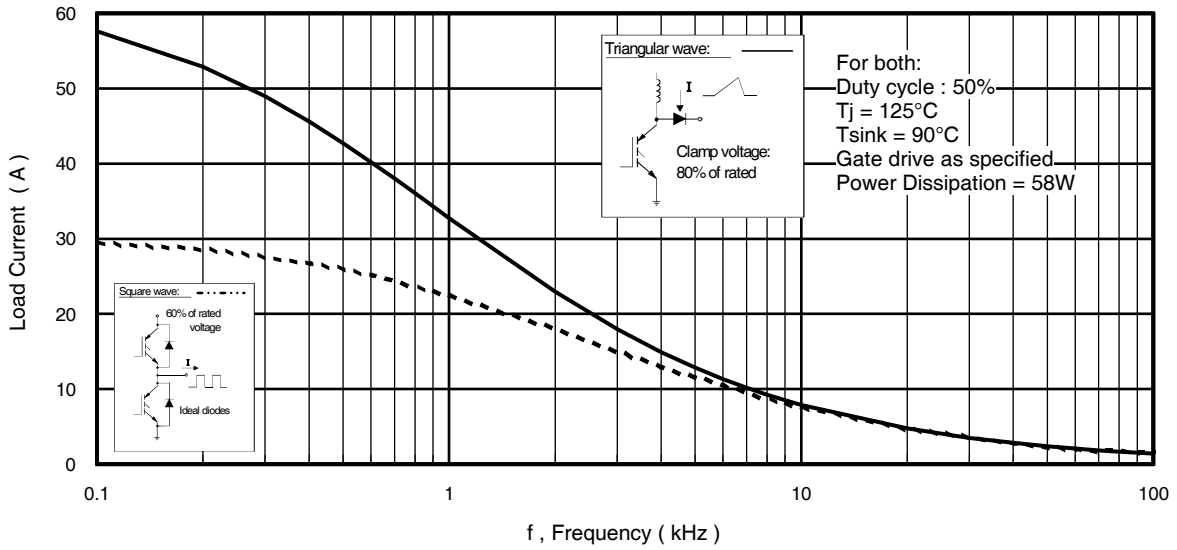
Parameter	Min.	Typ.	Max.	Units	Conditions	
V <sub>(BR)CES</sub>	1200	—	—	V	V <sub>GE</sub> = 0V, I <sub>C</sub> = 250μA	
V <sub>(BR)ECS</sub>	19	—	—	V	V <sub>GE</sub> = 0V, I <sub>C</sub> = 1.0A	
ΔV <sub>(BR)CES</sub> /ΔT <sub>J</sub>	—	0.78	—	V/°C	V <sub>GE</sub> = 0V, I <sub>C</sub> = 1mA	
V <sub>CE(on)</sub>	Collector-to-Emitter Saturation Voltage	—	2.52	2.70	V	I <sub>C</sub> = 70A, V <sub>GE</sub> = 15V I <sub>C</sub> = 140A, V <sub>GE</sub> = 15V I <sub>C</sub> = 70A, T <sub>J</sub> = 150°C See Fig.2, 5
		—	3.17	—		
		—	2.68	—		
V <sub>GE(th)</sub>	3.0	—	6.0		V <sub>CE</sub> = V <sub>GE</sub> , I <sub>C</sub> = 250μA	
ΔV <sub>GE(th)</sub> /ΔT <sub>J</sub>	—	-9.2	—	mV/°C	V <sub>CE</sub> = V <sub>GE</sub> , I <sub>C</sub> = 1.0mA	
g <sub>fe</sub>	48	72	—	S	V <sub>CE</sub> = 100V, I <sub>C</sub> = 70A	
I <sub>CES</sub>	Zero Gate Voltage Collector Current	—	—	500	μA	V <sub>GE</sub> = 0V, V <sub>CE</sub> = 1200V V <sub>GE</sub> = 0V, V <sub>CE</sub> = 10V V <sub>GE</sub> = 0V, V <sub>CE</sub> = 1200V, T <sub>J</sub> = 150°C
		—	—	2.0		
		—	—	5000		
I <sub>GES</sub>	Gate-to-Emitter Leakage Current	—	—	±100	nA	V <sub>GE</sub> = ±20V

## Switching Characteristics @ T<sub>J</sub> = 25°C (unless otherwise specified)

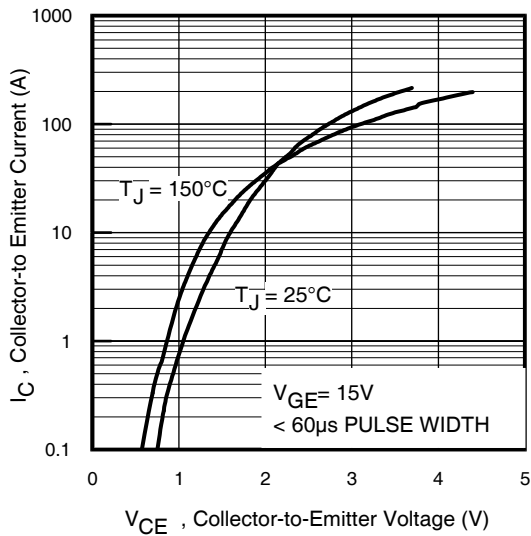
Parameter	Min.	Typ.	Max.	Units	Conditions
Q <sub>g</sub>	—	370	560	nC	I <sub>C</sub> = 70A V <sub>CC</sub> = 400V V <sub>GE</sub> = 15V See Fig.8
Q <sub>ge</sub>	—	61	24		
Q <sub>gc</sub>	—	120	50		
t <sub>d(on)</sub>	—	51	—	ns	I <sub>C</sub> = 70A, V <sub>CC</sub> = 960V V <sub>GE</sub> = 15V, R <sub>G</sub> = 5.0Ω Energy losses include "tail" See Fig. 9, 10, 11, 14
t <sub>r</sub>	—	70	—		
t <sub>d(off)</sub>	—	280	390		
t <sub>f</sub>	—	170	260		
E <sub>on</sub>	—	4.77	—		
E <sub>off</sub>	—	9.54	—	mJ	
E <sub>tot</sub>	—	14.3	15.8		
t <sub>d(on)</sub>	—	49	—	ns	T <sub>J</sub> = 150°C, See Fig. 9, 10, 11, 14 I <sub>C</sub> = 70A, V <sub>CC</sub> = 960V V <sub>GE</sub> = 15V, R <sub>G</sub> = 5.0Ω Energy losses include "tail"
t <sub>r</sub>	—	70	—		
t <sub>d(off)</sub>	—	390	—		
t <sub>f</sub>	—	360	—		
E <sub>TS</sub>	—	25	—	mJ	
L <sub>E</sub>	—	13	—	nH	Measured 5mm from package
C <sub>ies</sub>	—	7280	—	pF	V <sub>GE</sub> = 0V V <sub>CC</sub> = 30V, f = 1.0MHz See Fig.7
C <sub>oes</sub>	—	290	—		
C <sub>res</sub>	—	50	—		

### Notes:

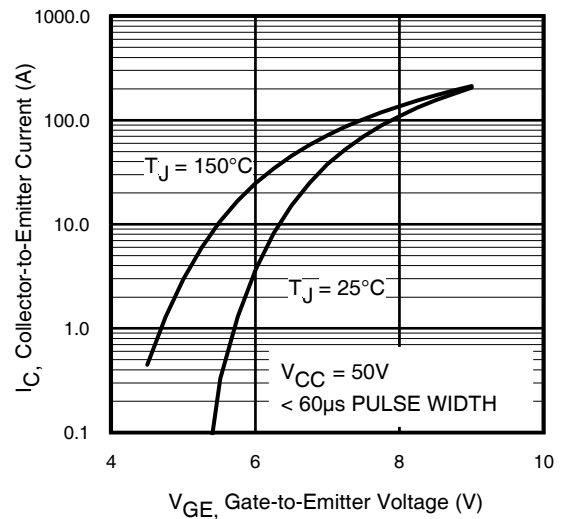
- ① Repetitive rating; V<sub>GE</sub>=20V; pulse width limited by maximum junction temperature (figure 20)
- ② V<sub>CC</sub>=80%(V<sub>CES</sub>), V<sub>GE</sub>=20V, L=10μH, R<sub>G</sub>= 5.0 Ω (figure 13a)
- ③ Pulse width ≤ 80μs; duty factor ≤ 0.1%.
- ④ Pulse width 5.0μs, single shot.
- ⑤ Repetitive rating; pulse width limited by maximum junction temperature.



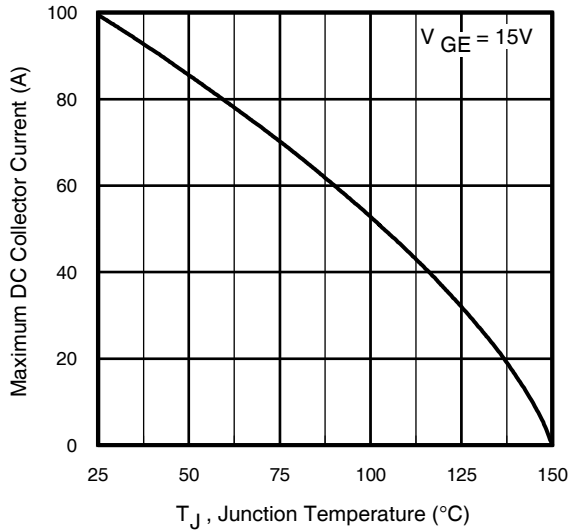
**Fig. 1 - Typical Load Current vs. Frequency**  
 (For square wave,  $I = I_{\text{RMS}}$  of fundamental; for triangular wave,  $I = I_{\text{PK}}$ )



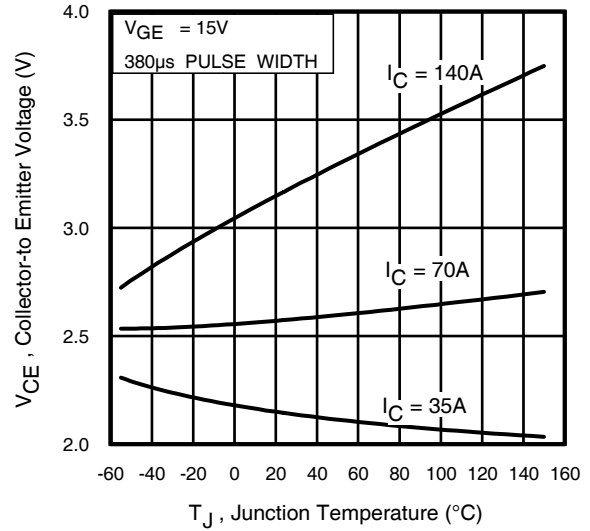
**Fig. 2 - Typical Output Characteristics**



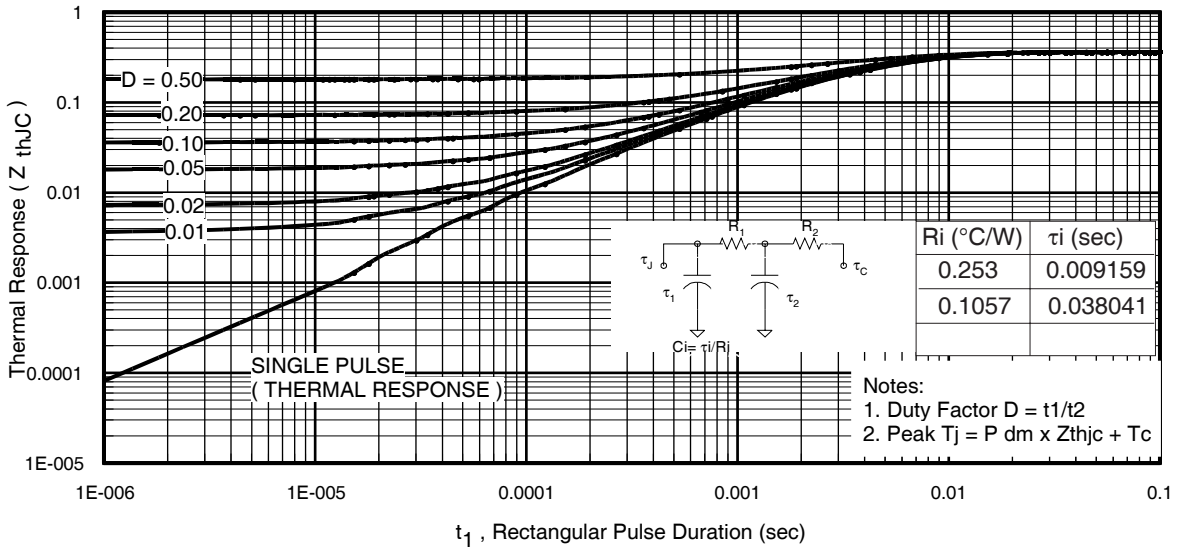
**Fig. 3 - Typical Transfer Characteristics**



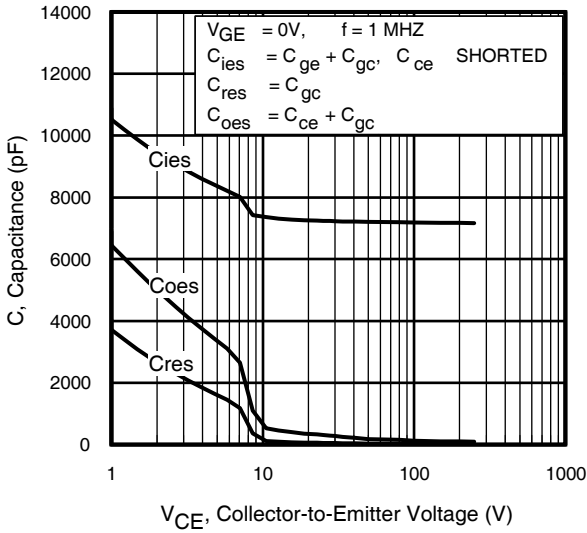
**Fig. 4 - Maximum Collector Current vs. Case Temperature**



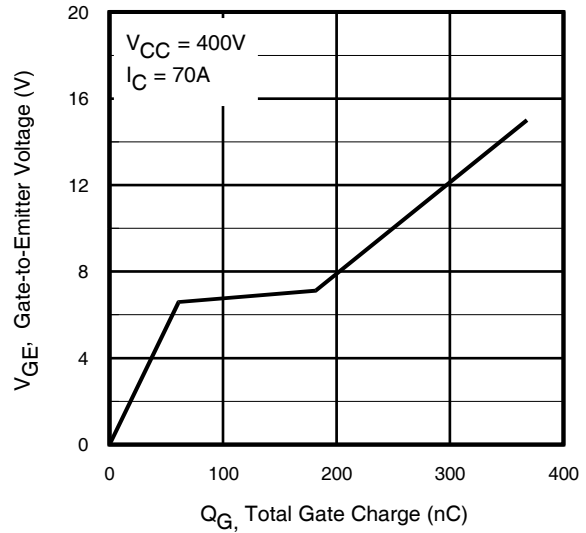
**Fig. 5 - Collector-to-Emitter Voltage vs. Junction Temperature**



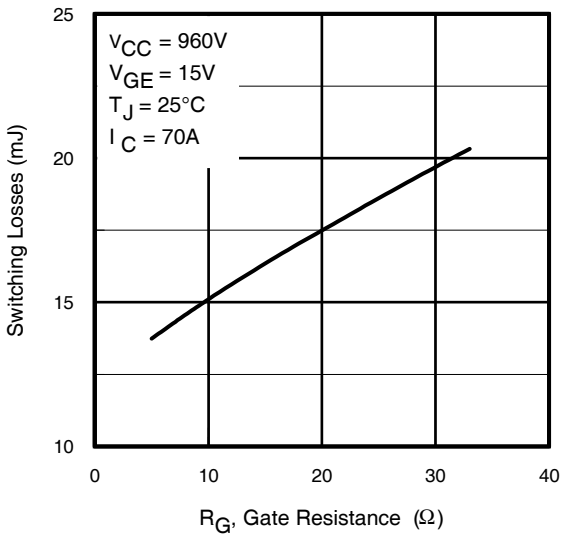
**Fig. 6 - Maximum Effective Transient Thermal Impedance, Junction-to-Case**



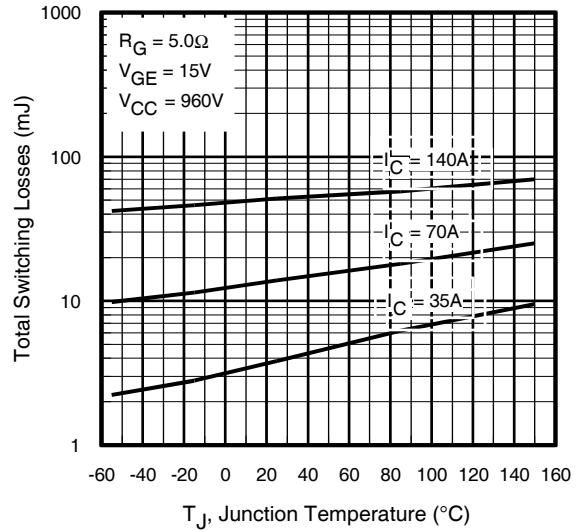
**Fig. 7** - Typical Capacitance vs. Collector-to-Emitter Voltage



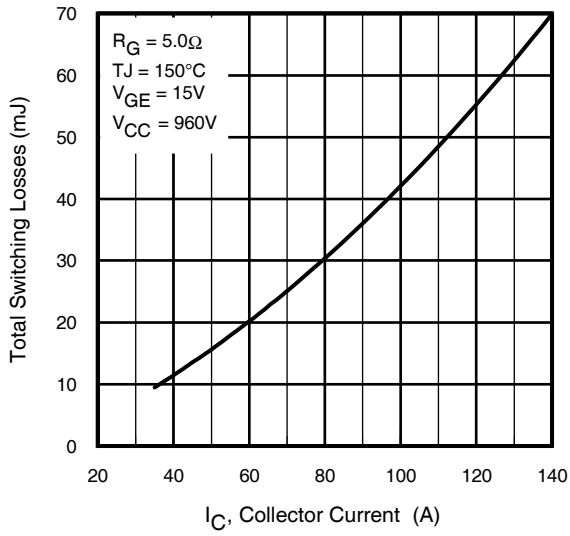
**Fig. 8** - Typical Gate Charge vs. Gate-to-Emitter Voltage



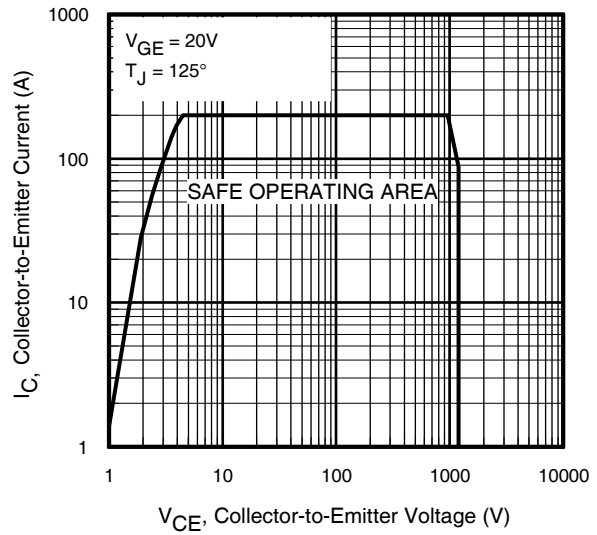
**Fig. 9** - Typical Switching Losses vs. Gate Resistance



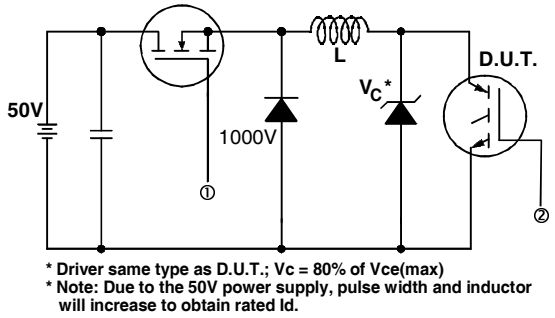
**Fig. 10** - Typical Switching Losses vs. Junction Temperature



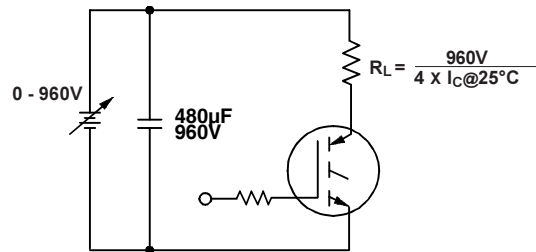
**Fig. 11** - Typical Switching Losses vs. Collector-to-Emitter Current



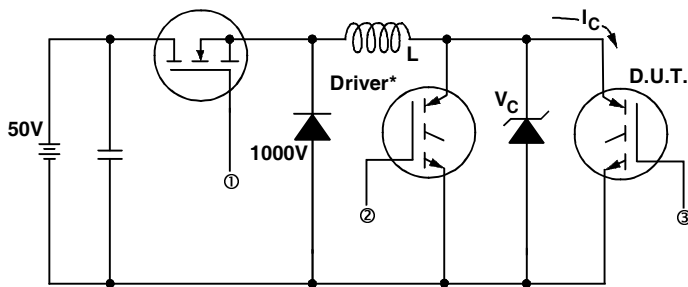
**Fig. 12** - Turn-Off SOA



**Fig. 13a** - Clamped Inductive Load Test Circuit

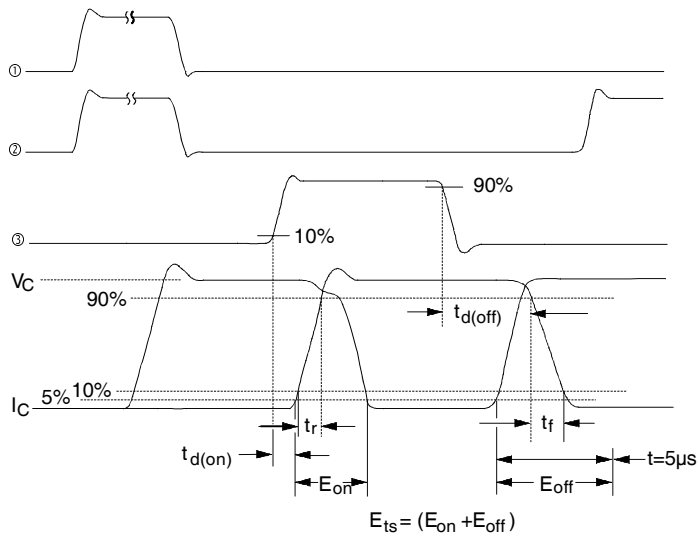


**Fig. 13b** - Pulsed Collector Current Test Circuit



**Fig. 14a** - Switching Loss Test Circuit

\* Driver same type as D.U.T.,  $V_C = 960V$

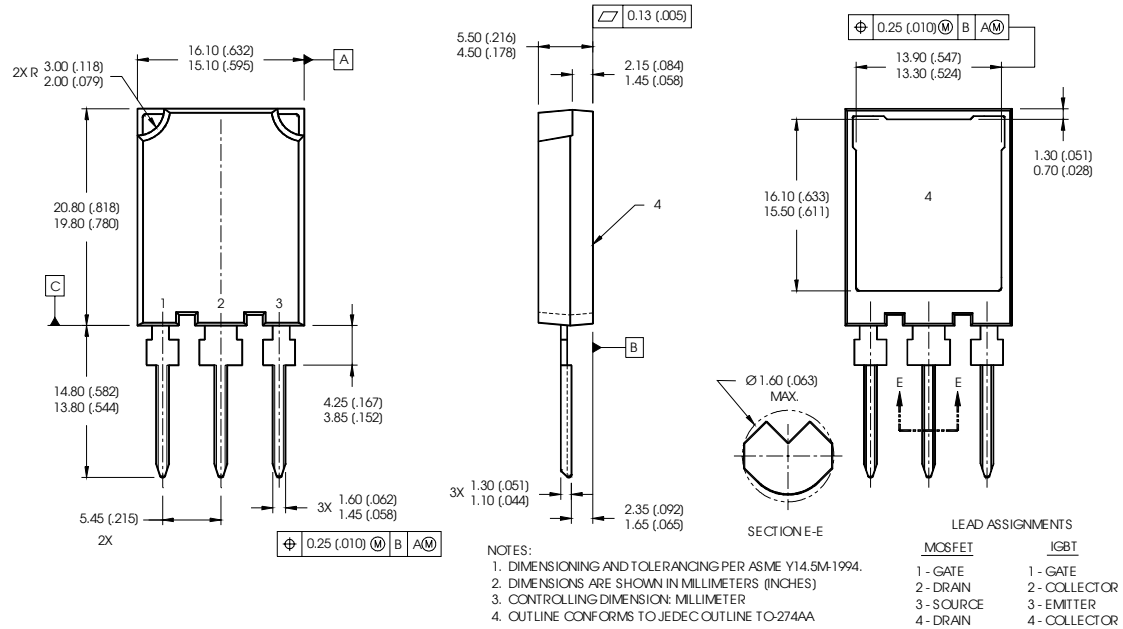


**Fig. 14b** - Switching Loss Waveforms

# IRG4PSH71U

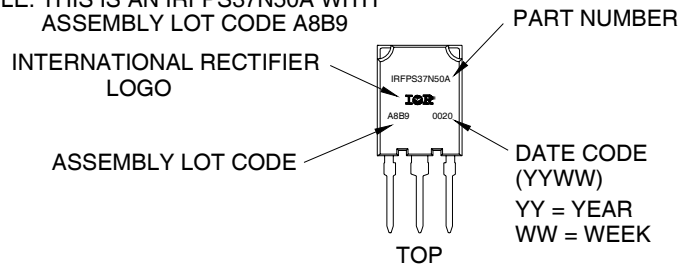
International  
**IR** Rectifier

## Super-247™ (TO-274AA) Package Outline



## Super-247™ (TO-274AA) Part Marking Information

EXAMPLE: THIS IS AN IRFPS37N50A WITH ASSEMBLY LOT CODE A8B9



**Super TO-247™ package is not recommended for Surface Mount Application.**

Data and specifications subject to change without notice.  
 This product has been designed and qualified for the Consumer market.  
 Qualification Standards can be found on IR's Web site.

International  
**IR** Rectifier

IR WORLD HEADQUARTERS: 233 Kansas St., El Segundo, California 90245, USA Tel: (310) 252-7105  
 TAC Fax: (310) 252-7903

Visit us at [www.irf.com](http://www.irf.com) for sales contact information.5/04

[www.irf.com](http://www.irf.com)