

International  
**IR** Rectifier

PD - 95035

# IRG4RC10KDPbF

INSULATED GATE BIPOLAR TRANSISTOR WITH  
ULTRAFAST SOFT RECOVERY DIODE

Short Circuit Rated  
UltraFast IGBT

## Features

- Short Circuit Rated UltraFast: Optimized for high operating frequencies >5.0 kHz , and Short Circuit Rated to 10 $\mu$ s @ 125°C,  $V_{GE} = 15V$
- Generation 4 IGBT design provides tighter parameter distribution and higher efficiency than previous generation
- IGBT co-packaged with HEXFRED™ ultrafast, ultra-soft-recovery anti-parallel diodes for use in bridge configurations
- Industry standard TO-252AA package
- Lead-Free

## Benefits

- Latest generation 4 IGBT's offer highest power density motor controls possible
- HEXFRED™ diodes optimized for performance with IGBTs. Minimized recovery characteristics reduce noise, EMI and switching losses
- For hints see design tip 97003

## Absolute Maximum Ratings

	Parameter	Max.	Units
$V_{CES}$	Collector-to-Emitter Voltage	600	V
$I_C @ T_C = 25^\circ C$	Continuous Collector Current	9.0	A
$I_C @ T_C = 100^\circ C$	Continuous Collector Current	5.0	
$I_{CM}$	Pulsed Collector Current ①	18	
$I_{LM}$	Clamped Inductive Load Current ②	18	
$I_F @ T_C = 100^\circ C$	Diode Continuous Forward Current	4.0	
$I_{FM}$	Diode Maximum Forward Current	16	
$t_{sc}$	Short Circuit Withstand Time	10	$\mu$ s
$V_{GE}$	Gate-to-Emitter Voltage	$\pm 20$	V
$P_D @ T_C = 25^\circ C$	Maximum Power Dissipation	38	W
$P_D @ T_C = 100^\circ C$	Maximum Power Dissipation	15	
$T_J$	Operating Junction and	-55 to +150	°C
$T_{STG}$	Storage Temperature Range		
	Soldering Temperature, for 10 sec.	300 (0.063 in. (1.6mm) from case)	

## Thermal Resistance

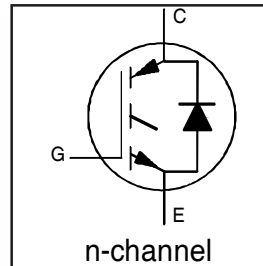
	Parameter	Typ.	Max.	Units
$R_{\theta JC}$	Junction-to-Case - IGBT	—	3.3	°C/W
$R_{\theta JC}$	Junction-to-Case - Diode	—	7.0	
$R_{\theta JA}$	Junction-to-Ambient (PCB mount)*	—	50	
Wt	Weight	0.3 (0.01)	—	g (oz)

\* When mounted on 1" square PCB (FR-4 or G-10 Material).

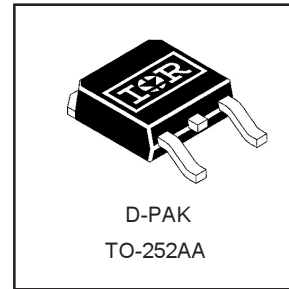
For recommended footprint and soldering techniques refer to application note #AN-994

www.irf.com

www.DataSheet4U.com



$V_{CES} = 600V$
$V_{CE(on) typ.} = 2.39V$
@ $V_{GE} = 15V, I_C = 5.0A$



# IRG4RC10KDPbF

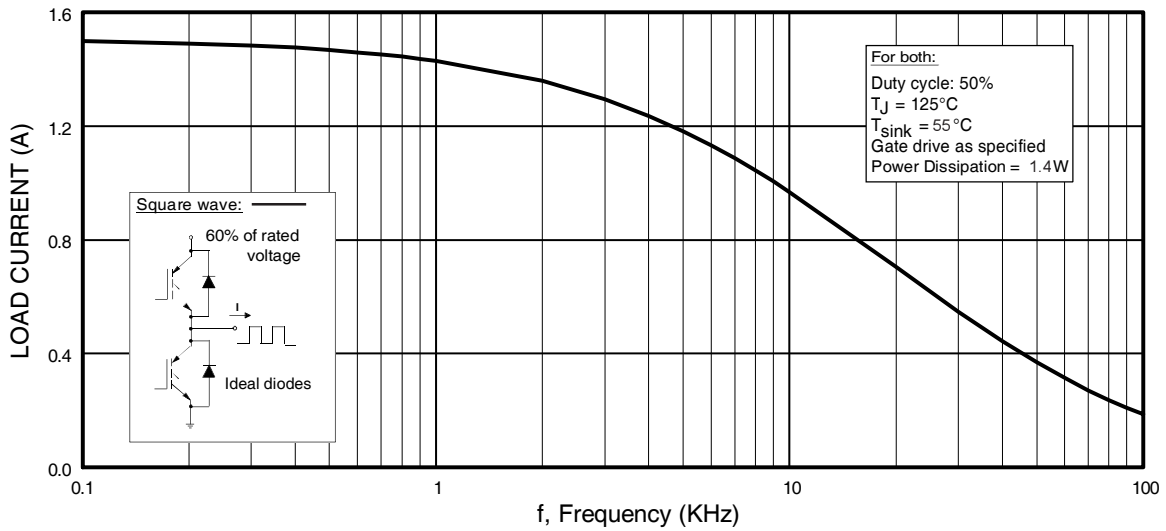
International  
IR Rectifier

## Electrical Characteristics @ $T_J = 25^\circ\text{C}$ (unless otherwise specified)

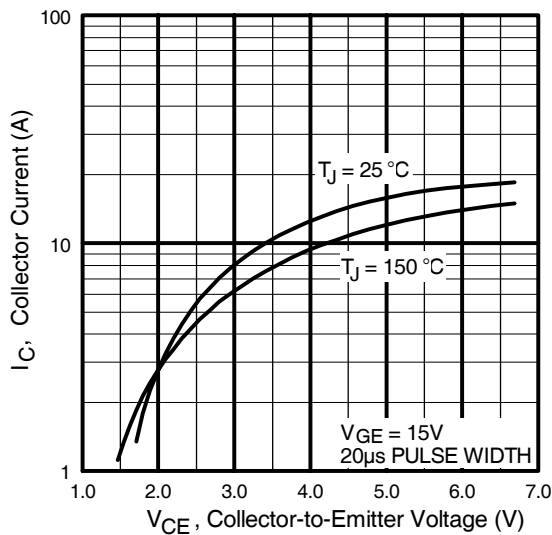
	Parameter	Min.	Typ.	Max.	Units	Conditions
$V_{(BR)CES}$	Collector-to-Emitter Breakdown Voltage <sub>f</sub>	600	—	—	V	$V_{GE} = 0V, I_C = 250\mu A$
$\Delta V_{(BR)CES}/\Delta T_J$	Temperature Coeff. of Breakdown Voltage	—	0.58	—	V/°C	$V_{GE} = 0V, I_C = 1.0mA$
$V_{CE(on)}$	Collector-to-Emitter Saturation Voltage	—	2.39	2.62	V	$I_C = 5.0A$ $V_{GE} = 15V$ See Fig. 2, 5
		—	3.25	—		
		—	2.63	—		
$V_{GE(th)}$	Gate Threshold Voltage	3.0	—	6.5		$V_{CE} = V_{GE}, I_C = 250\mu A$
$\Delta V_{GE(th)}/\Delta T_J$	Temperature Coeff. of Threshold Voltage	—	-11	—	mV/°C	$V_{CE} = V_{GE}, I_C = 250\mu A$
$g_{fe}$	Forward Transconductance „	1.2	1.8	—	S	$V_{CE} = 50V, I_C = 5.0A$
$I_{CES}$	Zero Gate Voltage Collector Current	—	—	250	$\mu A$	$V_{GE} = 0V, V_{CE} = 600V$ $V_{GE} = 0V, V_{CE} = 600V, T_J = 150^\circ C$
		—	—	1000		
$V_{FM}$	Diode Forward Voltage Drop	—	1.5	1.8	V	$I_C = 4.0A$ See Fig. 13
		—	1.4	1.7		
$I_{GES}$	Gate-to-Emitter Leakage Current	—	—	$\pm 100$	nA	$V_{GE} = \pm 20V$

## Switching Characteristics @ $T_J = 25^\circ\text{C}$ (unless otherwise specified)

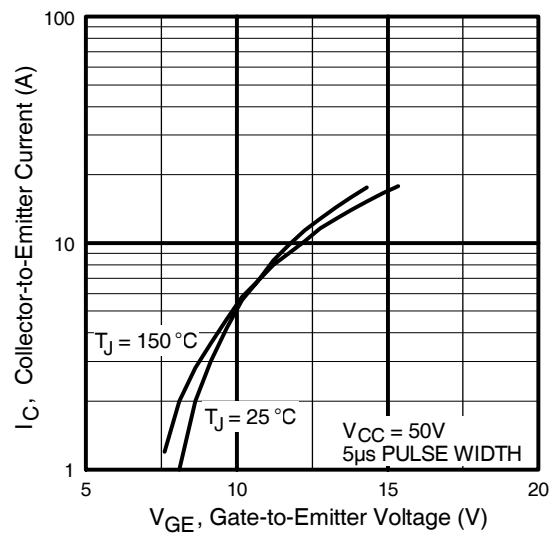
	Parameter	Min.	Typ.	Max.	Units	Conditions
$Q_g$	Total Gate Charge (turn-on)	—	19	29	nC	$I_C = 5.0A$ $V_{CC} = 400V$ $V_{GE} = 15V$ See Fig.8
$Q_{ge}$	Gate - Emitter Charge (turn-on)	—	2.9	4.3		
$Q_{gc}$	Gate - Collector Charge (turn-on)	—	9.8	15		
$t_{d(on)}$	Turn-On Delay Time	—	49	—	ns	$T_J = 25^\circ C$ $I_C = 5.0A, V_{CC} = 480V$ $V_{GE} = 15V, R_G = 100\Omega$
$t_r$	Rise Time	—	28	—		
$t_{d(off)}$	Turn-Off Delay Time	—	97	150		
$t_f$	Fall Time	—	140	210		
$E_{on}$	Turn-On Switching Loss	—	0.25	—	mJ	Energy losses include "tail" and diode reverse recovery See Fig. 9,10,14
$E_{off}$	Turn-Off Switching Loss	—	0.14	—		
$E_{ts}$	Total Switching Loss	—	0.39	0.48		
$t_{sc}$	Short Circuit Withstand Time	10	—	—	$\mu s$	$V_{CC} = 360V, T_J = 125^\circ C$ $V_{GE} = 15V, R_G = 100\Omega, V_{CPK} < 500V$
$t_{d(on)}$	Turn-On Delay Time	—	46	—	ns	$T_J = 150^\circ C$ , See Fig. 10,11,14 $I_C = 5.0A, V_{CC} = 480V$ $V_{GE} = 15V, R_G = 100\Omega$
$t_r$	Rise Time	—	32	—		
$t_{d(off)}$	Turn-Off Delay Time	—	100	—		
$t_f$	Fall Time	—	310	—		
$E_{ts}$	Total Switching Loss	—	0.56	—	mJ	Energy losses include "tail" and diode reverse recovery
$L_E$	Internal Emitter Inductance	—	7.5	—	nH	Measured 5mm from package
$C_{ies}$	Input Capacitance	—	220	—	pF	$V_{GE} = 0V$ $V_{CC} = 30V$ See Fig. 7 $f = 1.0MHz$
$C_{oes}$	Output Capacitance	—	29	—		
$C_{res}$	Reverse Transfer Capacitance	—	7.5	—		
$t_{rr}$	Diode Reverse Recovery Time	—	28	42	ns	$T_J = 25^\circ C$ See Fig. 14 $T_J = 125^\circ C$ 14
		—	38	57		
$I_{rr}$	Diode Peak Reverse Recovery Current	—	2.9	5.2	A	$T_J = 25^\circ C$ See Fig. 15 $T_J = 125^\circ C$ 15
		—	3.7	6.7		
$Q_{rr}$	Diode Reverse Recovery Charge	—	40	60	nC	$T_J = 25^\circ C$ See Fig. 16 $T_J = 125^\circ C$ 16
		—	70	105		
$di_{(rec)M}/dt$	Diode Peak Rate of Fall of Recovery During $t_b$	—	280	—	A/ $\mu s$	$T_J = 25^\circ C$ See Fig. 17 $T_J = 125^\circ C$ 17
		—	235	—		



**Fig. 1** - Typical Load Current vs. Frequency  
 (Load Current =  $I_{\text{RMS}}$  of fundamental)



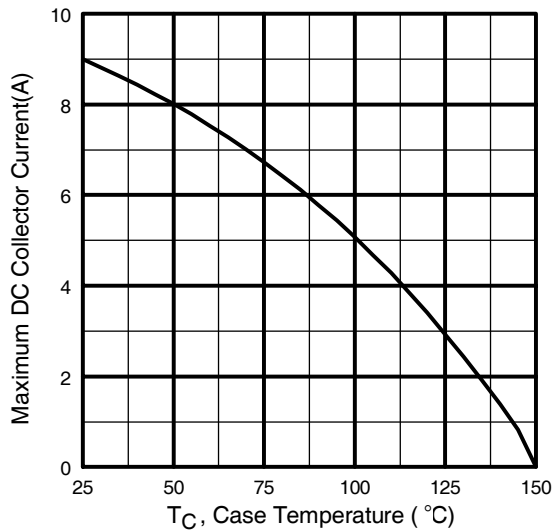
**Fig. 2** - Typical Output Characteristics



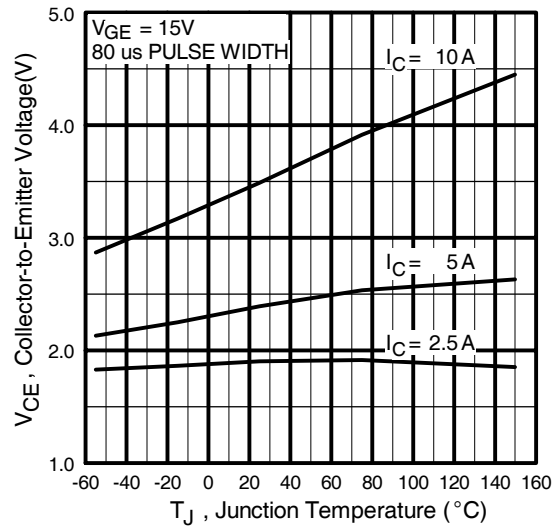
**Fig. 3** - Typical Transfer Characteristics

# IRG4RC10KDPbF

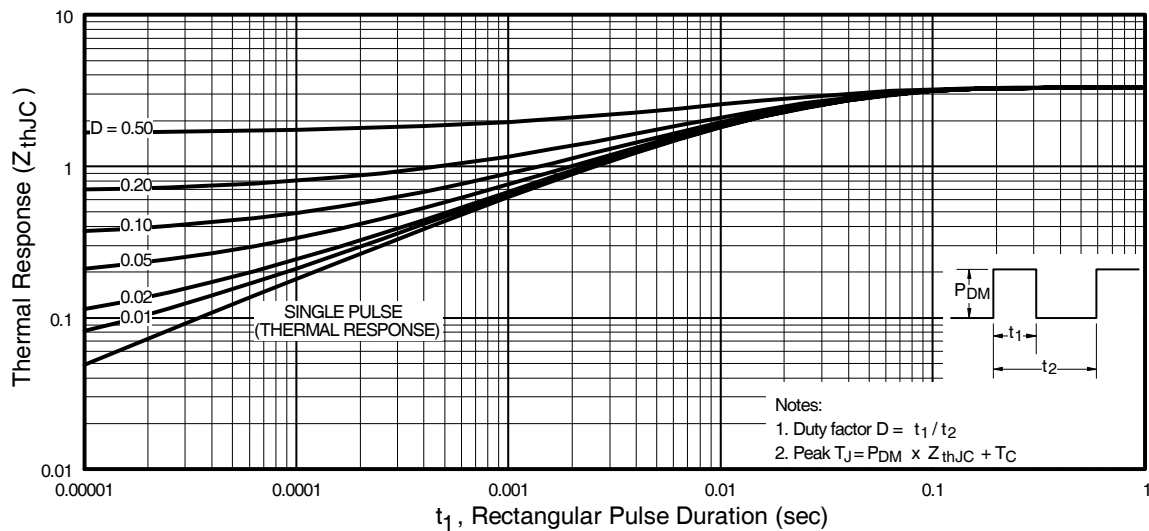
International  
**IRF** Rectifier



**Fig. 4** - Maximum Collector Current vs. Case Temperature

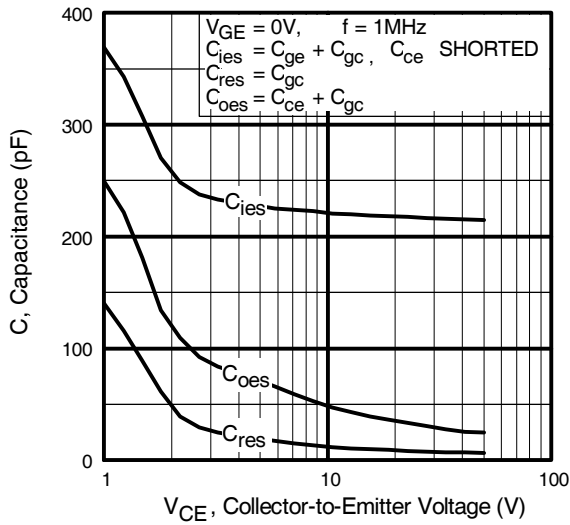


**Fig. 5** - Typical Collector-to-Emitter Voltage vs. Junction Temperature

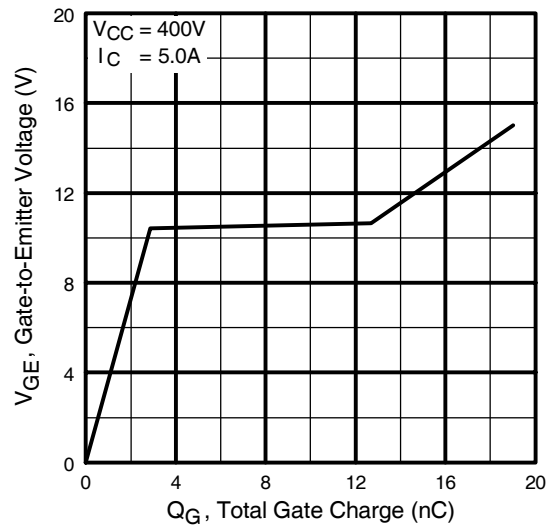


**Fig. 6** - Maximum Effective Transient Thermal Impedance, Junction-to-Case

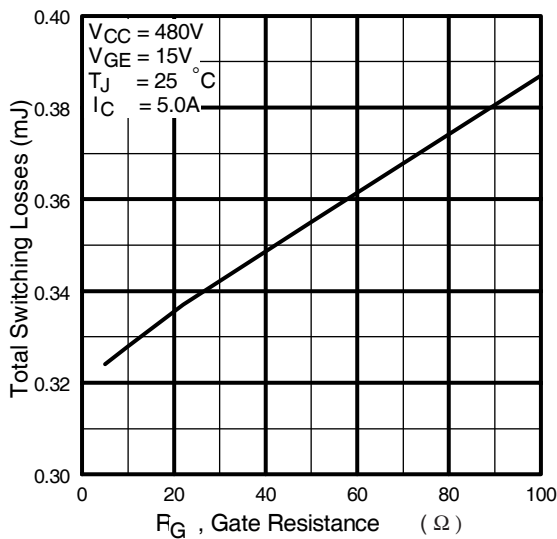
# IRG4RC10KDPbF



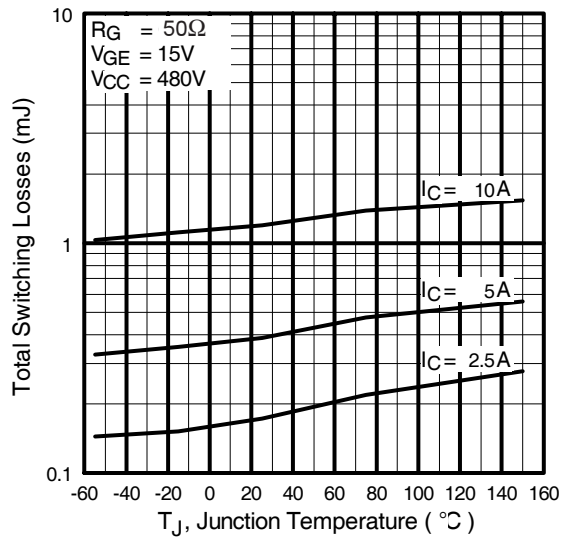
**Fig. 7** - Typical Capacitance vs. Collector-to-Emitter Voltage



**Fig. 8** - Typical Gate Charge vs. Gate-to-Emitter Voltage



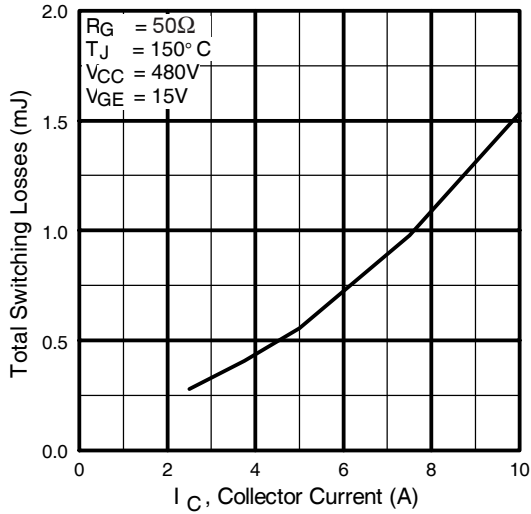
**Fig. 9** - Typical Switching Losses vs. Gate Resistance



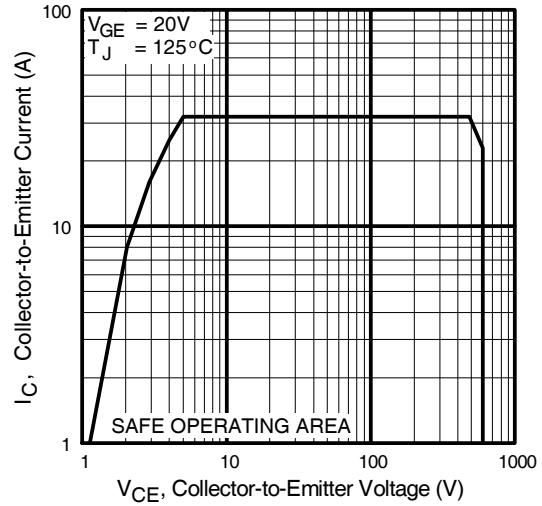
**Fig. 10** - Typical Switching Losses vs. Junction Temperature

# IRG4RC10KDPbF

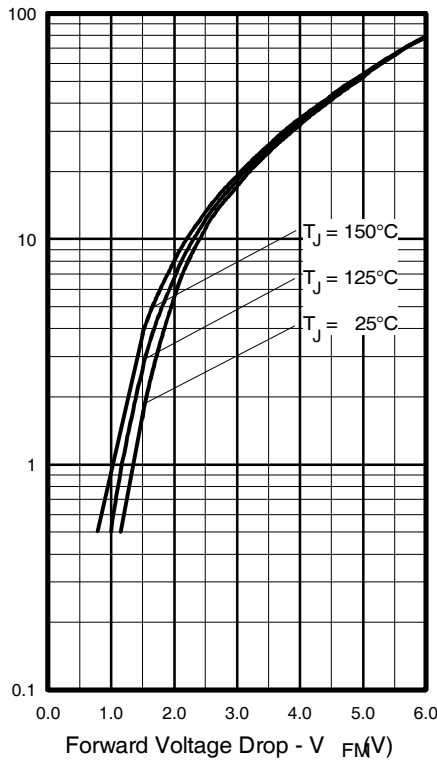
International  
**IR** Rectifier



**Fig. 11** - Typical Switching Losses vs. Collector-to-Emitter Current



**Fig. 12** - Turn-Off SOA



**Fig. 13** - Maximum Forward Voltage Drop vs. Instantaneous Forward Current

International  
**IR** Rectifier

# IRG4RC10KDPbF

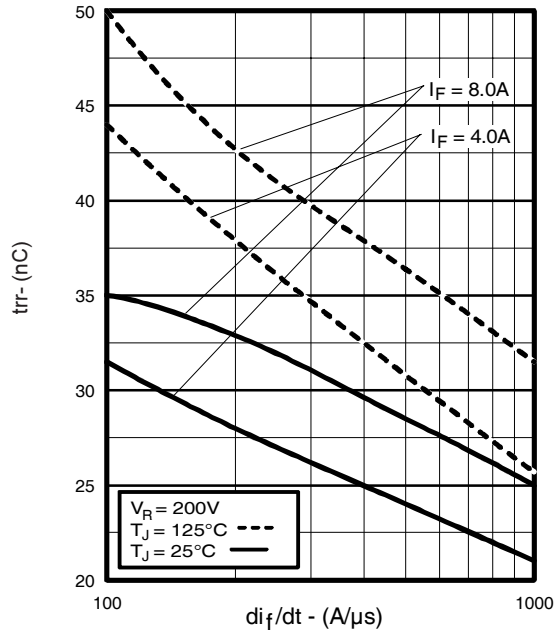


Fig. 14 - Typical Reverse Recovery vs.  $di_f/dt$

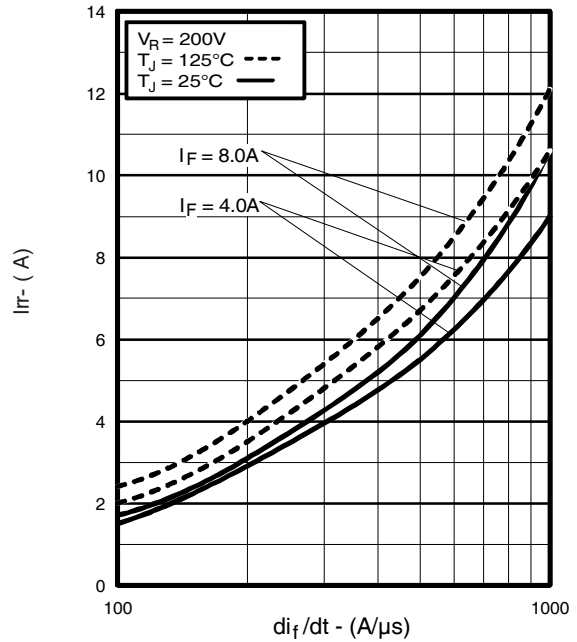


Fig. 15 - Typical Recovery Current vs.  $di_f/dt$

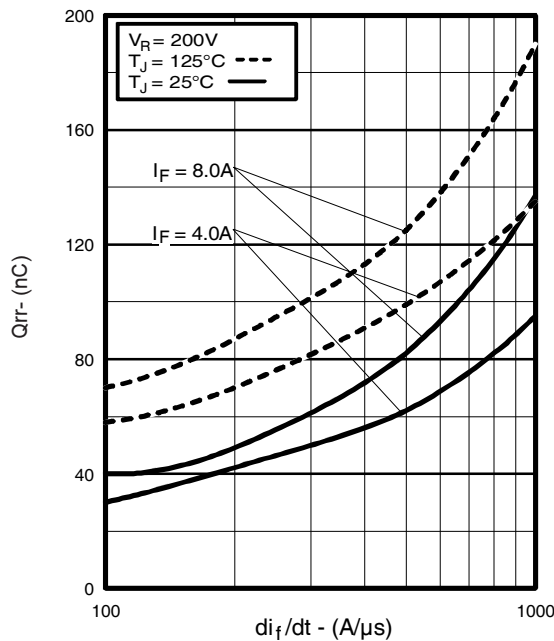


Fig. 16 - Typical Stored Charge vs.  $di_f/dt$

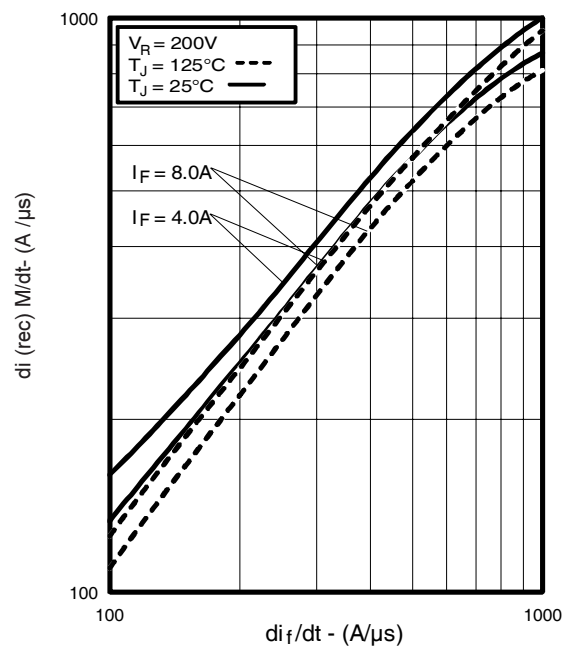
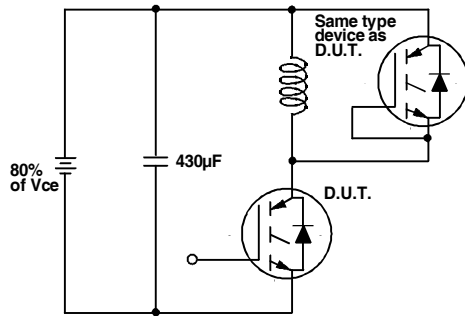


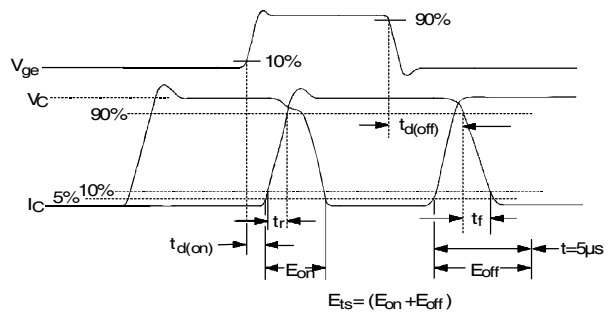
Fig. 17 - Typical  $di_{(rec)}M/dt$  vs.  $di_f/dt$ ,

# IRG4RC10KDPbF

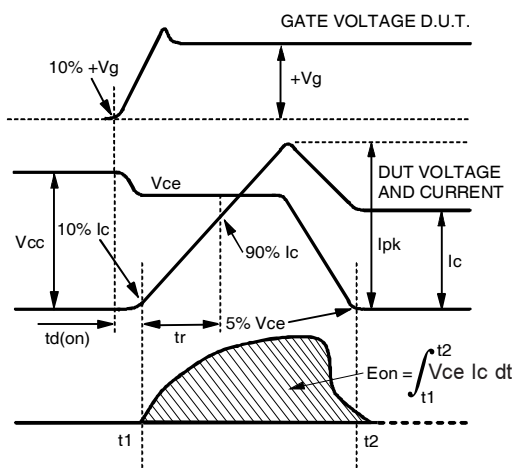
International  
**IRF** Rectifier



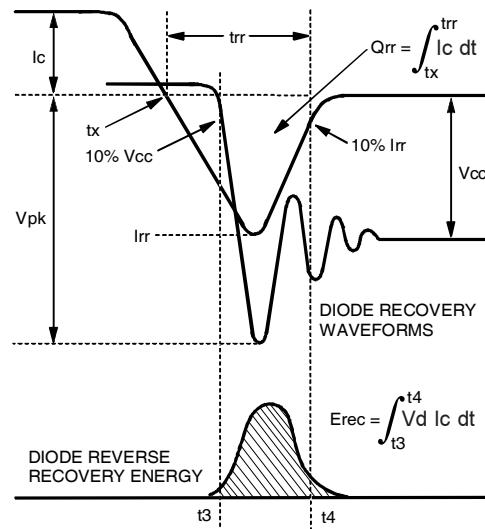
**Fig. 18a** - Test Circuit for Measurement of  $I_{LM}$ ,  $E_{on}$ ,  $E_{off}(\text{diode})$ ,  $t_{rr}$ ,  $Q_{rr}$ ,  $I_{rr}$ ,  $t_{d(on)}$ ,  $t_r$ ,  $t_{d(off)}$ ,  $t_f$



**Fig. 18b** - Test Waveforms for Circuit of Fig. 18a, Defining  $E_{off}$ ,  $t_{d(off)}$ ,  $t_f$



**Fig. 18c** - Test Waveforms for Circuit of Fig. 18a, Defining  $E_{on}$ ,  $t_{d(on)}$ ,  $t_r$



**Fig. 18d** - Test Waveforms for Circuit of Fig. 18a, Defining  $E_{rec}$ ,  $t_{rr}$ ,  $Q_{rr}$ ,  $I_{rr}$



# IRG4RC10KDPbF

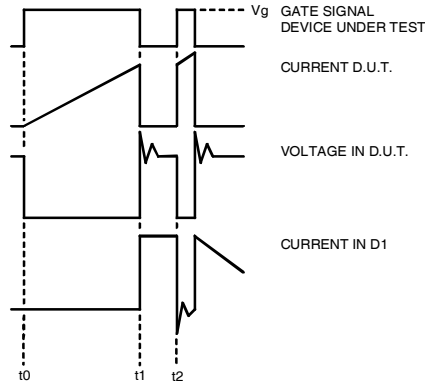


Figure 18e. Macro Waveforms for Figure 18a's Test Circuit

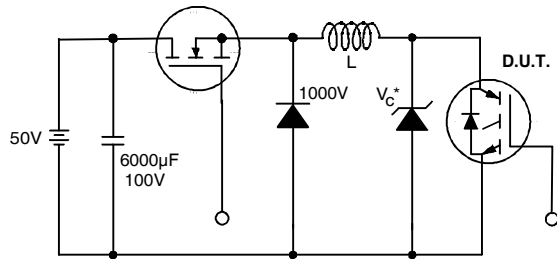


Figure 19. Clamped Inductive Load Test Circuit

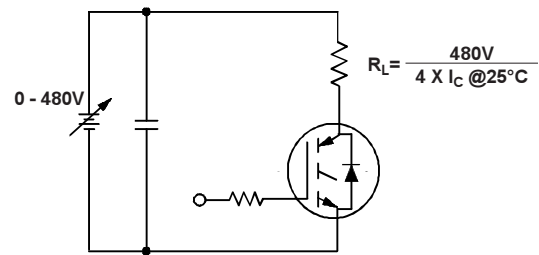


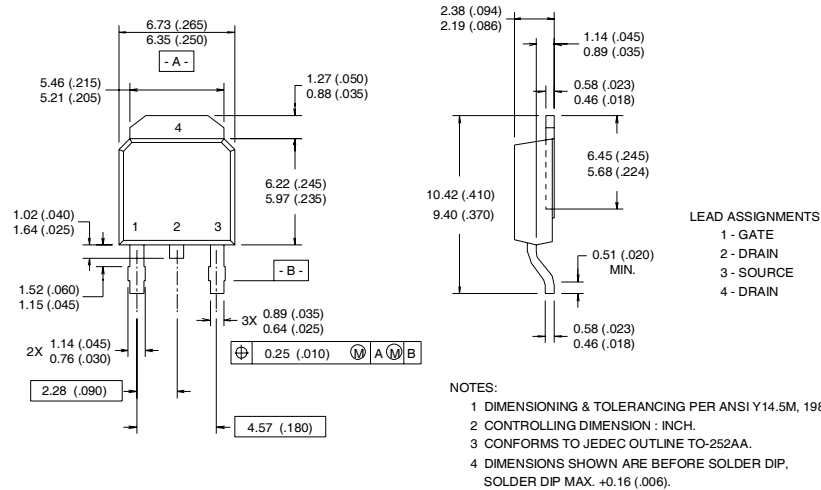
Figure 20. Pulsed Collector Current Test Circuit

# IRG4RC10KDPbF



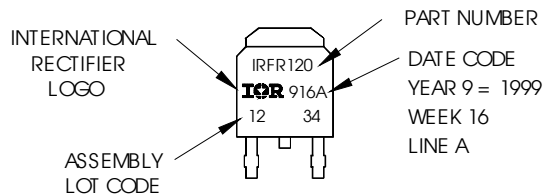
## D-Pak (TO-252AA) Package Outline

Dimensions are shown in millimeters (inches)

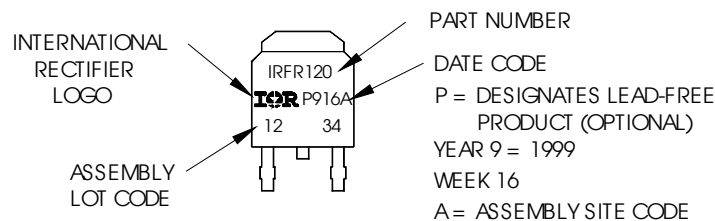


## D-Pak (TO-252AA) Part Marking Information (Lead-Free)

EXAMPLE: THIS IS AN IRFR120  
WITH ASSEMBLY  
LOT CODE 1234  
ASSEMBLED ON WW 16, 1999  
IN THE ASSEMBLY LINE "A"  
Note: "P" in assembly line  
position indicates "Lead-Free"



**OR**

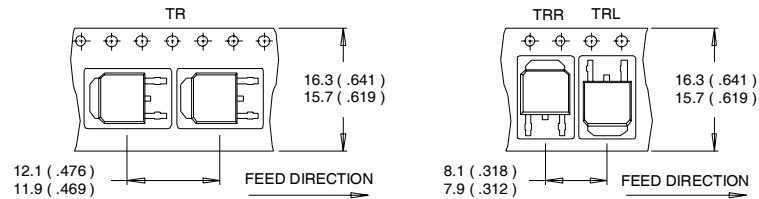


**Notes:**

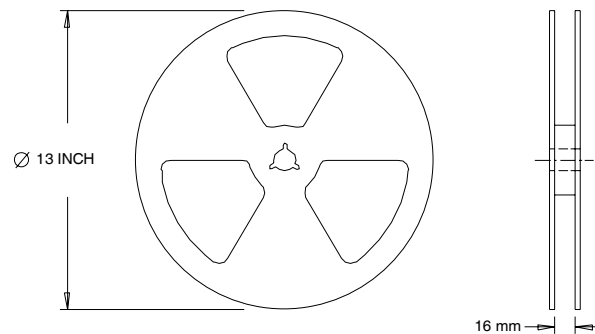
- ① Repetitive rating:  $V_{GE}=20V$ ; pulse width limited by maximum junction temperature (figure 20)
- ②  $V_{CC}=80\%(V_{CES})$ ,  $V_{GE}=20V$ ,  $L=10\mu H$ ,  $R_G=100\Omega$  (figure 19)
- ③ Pulse width  $\leq 80\mu s$ ; duty factor  $\leq 0.1\%$ .
- ④ Pulse width  $5.0\mu s$ , single shot.

**D-Pak (TO-252AA) Tape & Reel Information**

Dimensions are shown in millimeters (inches)

**NOTES :**

1. CONTROLLING DIMENSION : MILLIMETER.
2. ALL DIMENSIONS ARE SHOWN IN MILLIMETERS ( INCHES ).
3. OUTLINE CONFORMS TO EIA-481 & EIA-541.

**NOTES :**

1. OUTLINE CONFORMS TO EIA-481.

Data and specifications subject to change without notice.

Note: For the most current drawings please refer to the IR website at:  
<http://www.irf.com/package/>