

INSULATED GATE BIPOLAR TRANSISTOR WITH ULTRAFAST SOFT RECOVERY DIODE

Surface Mountable
Short Circuit Rated
UltraFast IGBT

Features

- High short circuit rating optimized for motor control, $t_{sc} = 10\mu s$, $V_{CC} = 720V$, $T_J = 125^\circ C$, $V_{GE} = 15V$
- IGBT co-packaged with HEXFRED™ ultrafast, ultra-soft-recovery antiparallel diodes for use in bridge configurations
- Combines low conduction losses with high switching speed
- Low profile low inductance SMD-10 Package
- Separated control & Power-connections for easy paralleling
- Inherently Good coplanarity
- Easy solder inspection and cleaning

Benefits

- Highest power density and efficiency available
- HEXFRED Diodes optimized for performance with IGBTs. Minimized recovery characteristics
- IGBTs optimized for specific application conditions

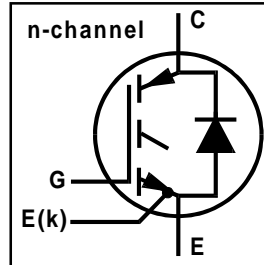

$$V_{CES} = 1200V$$

$$V_{CE(ON)typ} = 2.89V$$

$$@V_{GE} = 15V, I_C = 42A$$

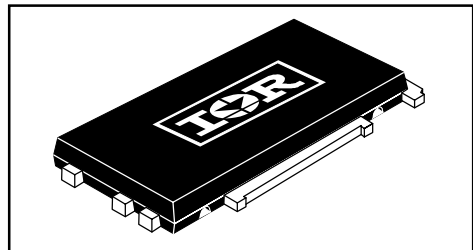

Absolute Maximum Ratings

	Parameter	Max.	Units
V_{CES}	Collector-to-Emitter Voltage	1200	V
$I_C @ T_C = 25^\circ C$	Continuous Collector Current	78	A
$I_C @ T_C = 100^\circ C$	Continuous Collector Current	42	
I_{CM}	Pulsed Collector Current ①	156	
I_{LM}	Clamped Inductive Load Current ②	156	
$I_F @ T_C = 100^\circ C$	Diode Continuous Forward Current	42	
I_{FM}	Diode Maximum Forward Current	156	
t_{sc}	Short Circuit Withstand Time	10	μs
V_{GE}	Gate-to-Emitter Voltage	± 20	V
$P_D @ T_C = 25^\circ C$	Maximum Power Dissipation	350	W
$P_D @ T_C = 100^\circ C$	Maximum Power Dissipation	140	
T_J T_{STG}	Operating Junction and Storage Temperature Range	-55 to +150	$^\circ C$

Thermal Resistance

	Parameter	Min.	Typ.	Max.	Units
$R_{\theta JC}$	Junction-to-Case - IGBT	—	—	0.36	$^\circ C/W$
$R_{\theta JC}$	Junction-to-Case - Diode	—	—	0.69	
$R_{\theta CS}$	SMD-10 Case-to-Heatsink (typical), *	—	0.44	—	
	Weight	—	6.0(0.21)	—	g (oz)

* Assumes device soldered to 3.0 oz. Cu on 3.0mm IMS/Aluminum board, mounted to flat, greased heatsink.

Electrical Characteristics @ T_J = 25°C (unless otherwise specified)

	Parameter	Min.	Typ.	Max.	Units	Conditions
V _{(BR)CES}	Collector-to-Emitter Breakdown Voltage ^③	1200	—	—	V	V _{GE} = 0V, I _C = 250μA
ΔV _{(BR)CES/ΔT_J}	Temperature Coeff. of Breakdown Voltage	—	0.26	—	V/°C	V _{GE} = 0V, I _C = 4.0mA
V _{CE(on)}	Collector-to-Emitter Saturation Voltage	—	2.89	3.9	V	I _C = 42A V _{GE} = 15V
		—	3.73	—		I _C = 78A
		—	2.55	—		I _C = 42A, T _J = 150°C
V _{GE(th)}	Gate Threshold Voltage	3.0	—	6.0		V _{CE} = V _{GE} , I _C = 250μA
ΔV _{GE(th)/ΔT_J}	Temperature Coeff. of Threshold Voltage	—	-11	—	mV/°C	V _{CE} = V _{GE} , I _C = 1.5mA
g _{fe}	Forward Transconductance ^④	23	34	—	S	V _{CE} = 50V, I _C = 42A
I _{CES}	Zero Gate Voltage Collector Current	—	—	500	μA	V _{GE} = 0V, V _{CE} = 1200V
		—	—	10	mA	V _{GE} = 0V, V _{CE} = 1200V, T _J = 150°C
V _{FM}	Diode Forward Voltage Drop	—	2.45	3.7	V	I _C = 42A See Fig. 13
		—	2.40	—		I _C = 42A, T _J = 150°C
I _{GES}	Gate-to-Emitter Leakage Current	—	—	±100	nA	V _{GE} = ±20V

Switching Characteristics @ T_J = 25°C (unless otherwise specified)

	Parameter	Min.	Typ.	Max.	Units	Conditions
Q _g	Total Gate Charge (turn-on)	—	380	570	nC	I _C = 42A V _{CC} = 400V See Fig.8 V _{GE} = 15V
Q _{ge}	Gate - Emitter Charge (turn-on)	—	48	72		
Q _{gc}	Gate - Collector Charge (turn-on)	—	120	180		
t _{d(on)}	Turn-On Delay Time	—	80	—	ns	T _J = 25°C I _C = 42A, V _{CC} = 800V V _{GE} = 15V, R _G = 5.0Ω
t _r	Rise Time	—	45	—		
t _{d(off)}	Turn-Off Delay Time	—	215	320		
t _f	Fall Time	—	220	330	mJ	Energy losses include "tail" and diode reverse recovery See Fig. 9,10,18
E _{on}	Turn-On Switching Loss	—	3.64	—		
E _{off}	Turn-Off Switching Loss	—	3.17	—		
E _{ts}	Total Switching Loss	—	6.81	9.8	μs	V _{CC} = 720V, T _J = 125°C V _{GE} = 15V, R _G = 5.0Ω
t _{sc}	Short Circuit Withstand Time	10	—	—		
t _{d(on)}	Turn-On Delay Time	—	91	—	ns	T _J = 150°C, See Fig. 10,11,18 I _C = 42A, V _{CC} = 800V V _{GE} = 15V, R _G = 5.0Ω, Energy losses include "tail" and diode reverse recovery
t _r	Rise Time	—	48	—		
t _{d(off)}	Turn-Off Delay Time	—	430	—		
t _f	Fall Time	—	400	—		
E _{ts}	Total Switching Loss	—	14.6	—		
L _E	Internal Emitter Inductance	—	2.0	—	nH	Measured 5mm from package
C _{ies}	Input Capacitance	—	5620	—	pF	V _{GE} = 0V V _{CC} = 30V See Fig. 7 f = 1.0MHz
C _{oes}	Output Capacitance	—	400	—		
C _{res}	Reverse Transfer Capacitance	—	94	—		
t _{rr}	Diode Reverse Recovery Time	—	107	160	ns	T _J = 25°C See Fig. 14
		—	160	240		T _J = 125°C
I _{rr}	Diode Peak Reverse Recovery Current	—	10	15	A	T _J = 25°C See Fig. 15
		—	16	24		T _J = 125°C
Q _{rr}	Diode Reverse Recovery Charge	—	680	1020	nC	T _J = 25°C See Fig. 16
		—	1400	2100		T _J = 125°C
di _{(rec)M/dt}	Diode Peak Rate of Fall of Recovery During t _b	—	250	—	A/μs	T _J = 25°C See Fig. 17
		—	320	—		T _J = 125°C

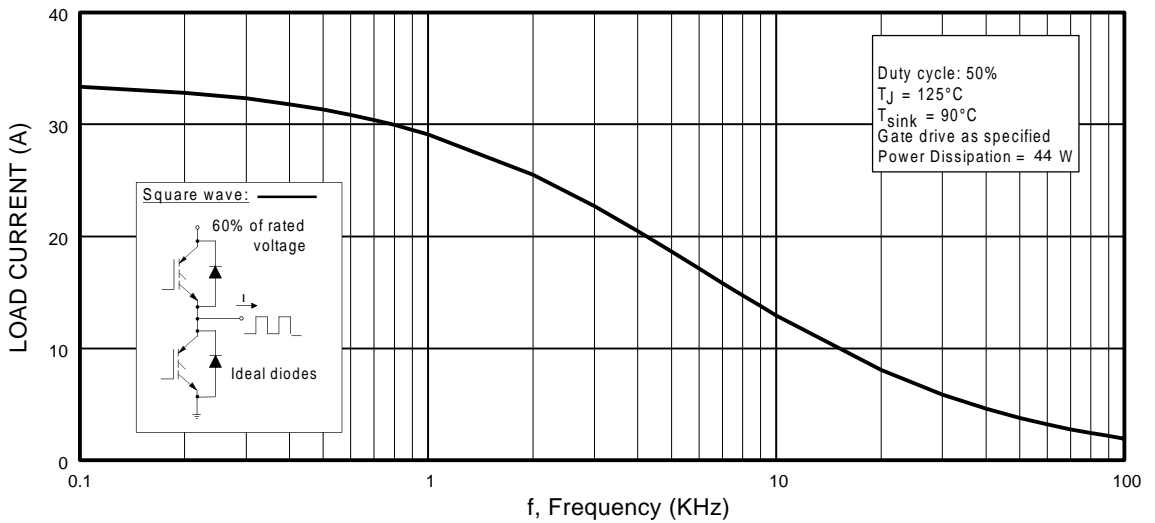

Fig. 1 - Typical Load Current vs. Frequency
 (Load Current = I_{RMS} of fundamental)

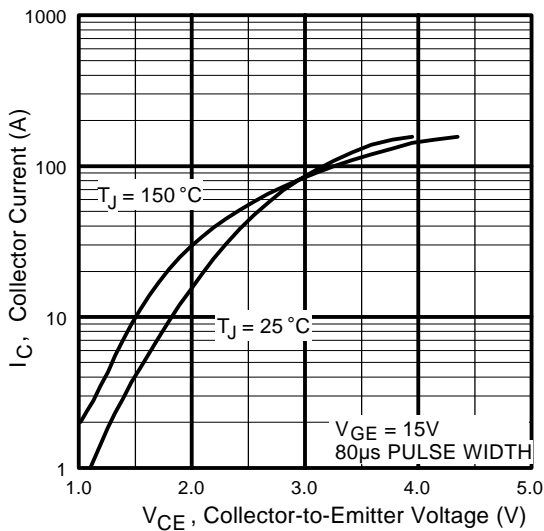

Fig. 2 - Typical Output Characteristics

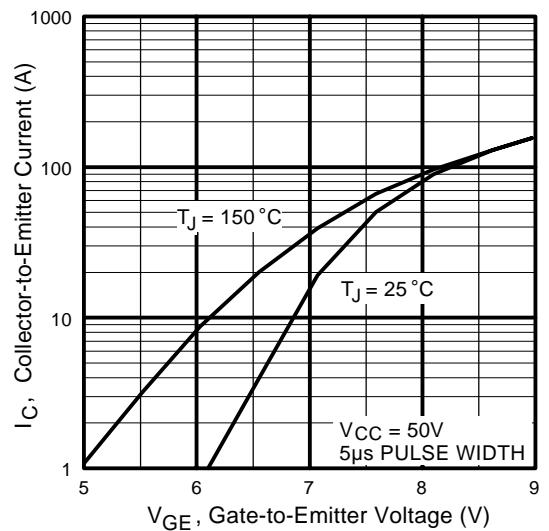

Fig. 3 - Typical Transfer Characteristics

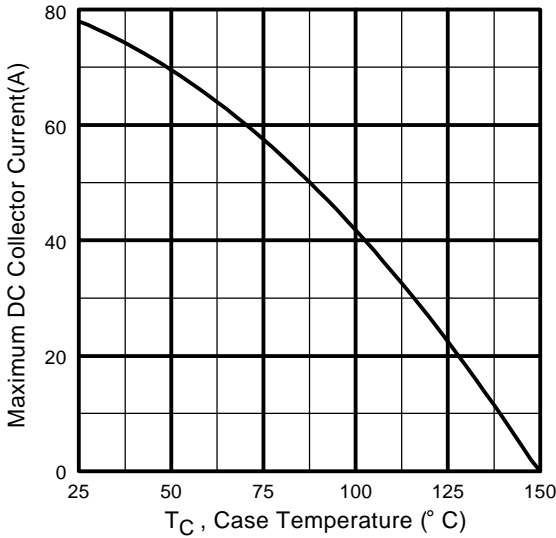

Fig. 4 - Maximum Collector Current vs. Case Temperature

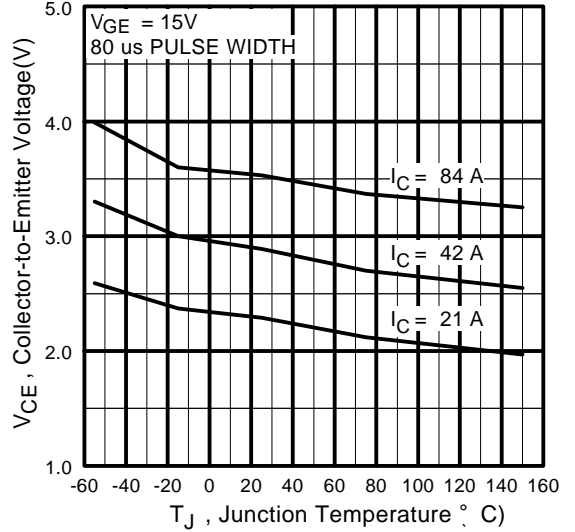

Fig. 5 - Typical Collector-to-Emitter Voltage vs. Junction Temperature

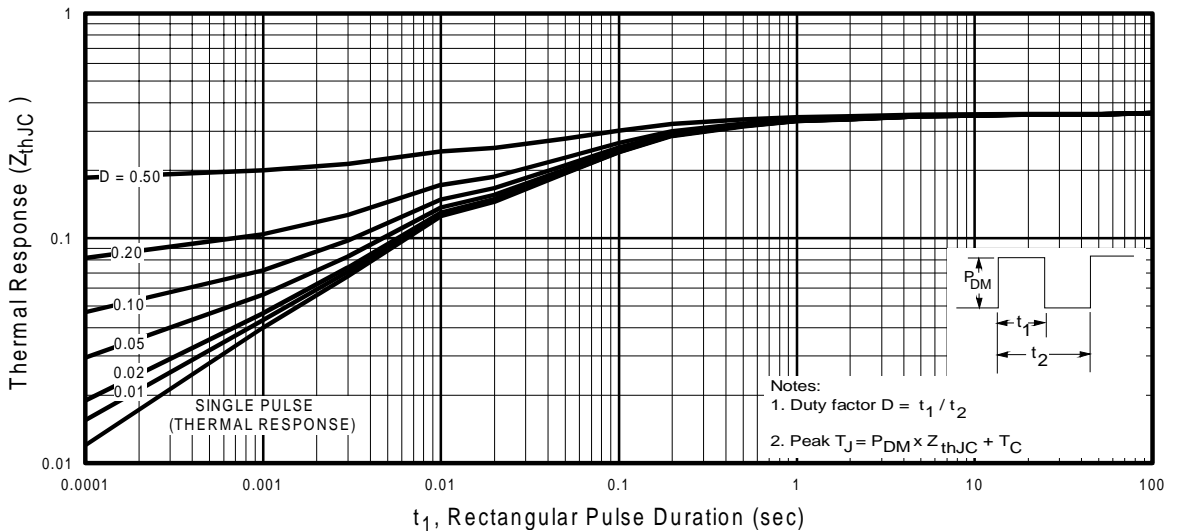

Fig. 6 - Maximum Effective Transient Thermal Impedance, Junction-to-Case

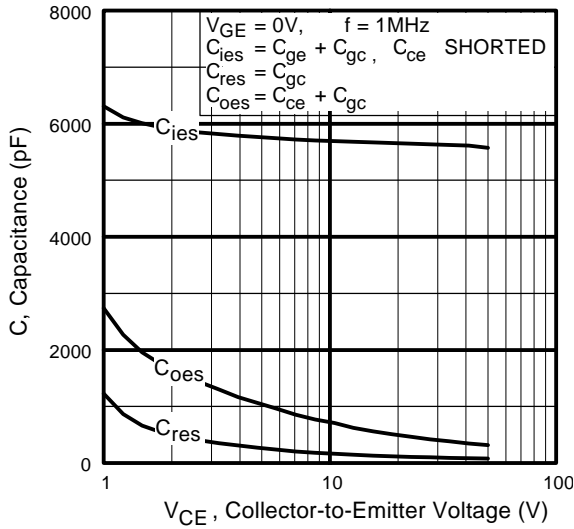

Fig. 7 - Typical Capacitance vs. Collector-to-Emitter Voltage

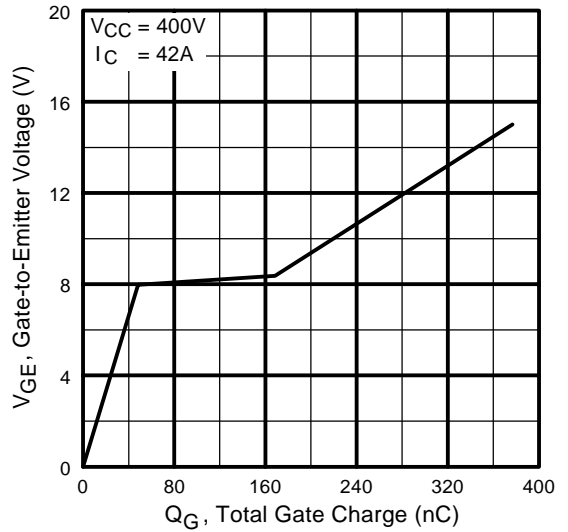

Fig. 8 - Typical Gate Charge vs. Gate-to-Emitter Voltage

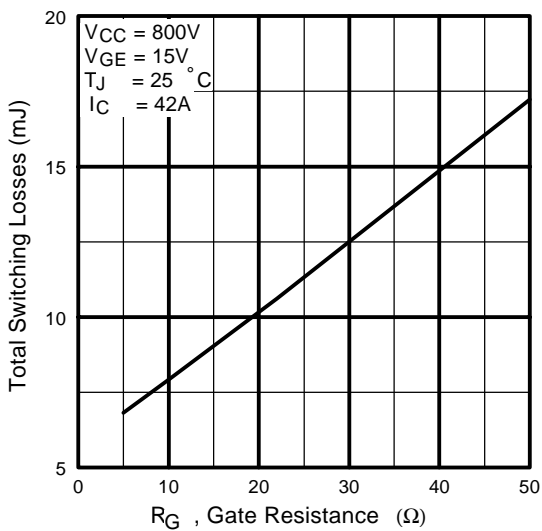

Fig. 9 - Typical Switching Losses vs. Gate Resistance

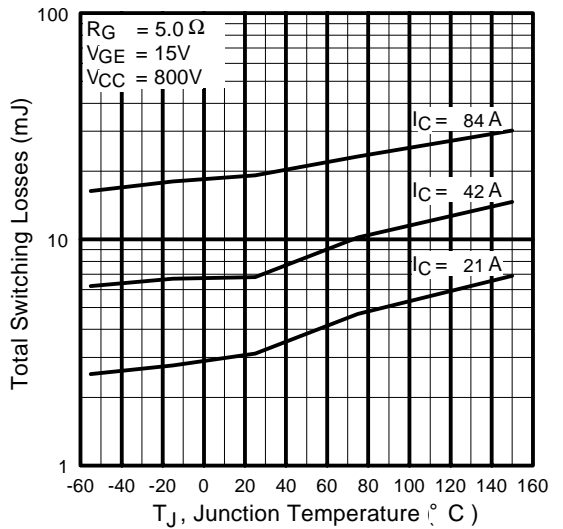

Fig. 10 - Typical Switching Losses vs. Junction Temperature

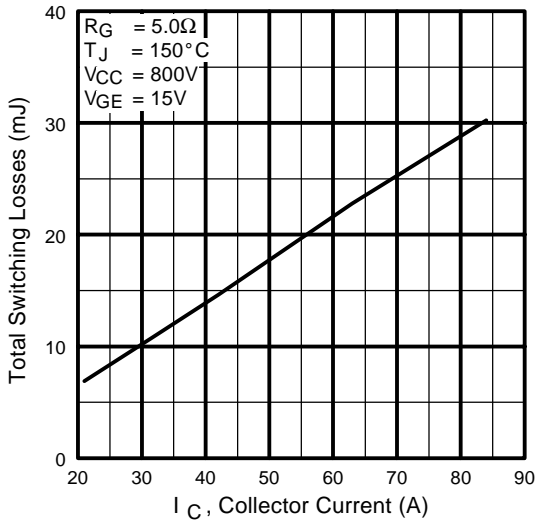

Fig. 11 - Typical Switching Losses vs. Collector Current

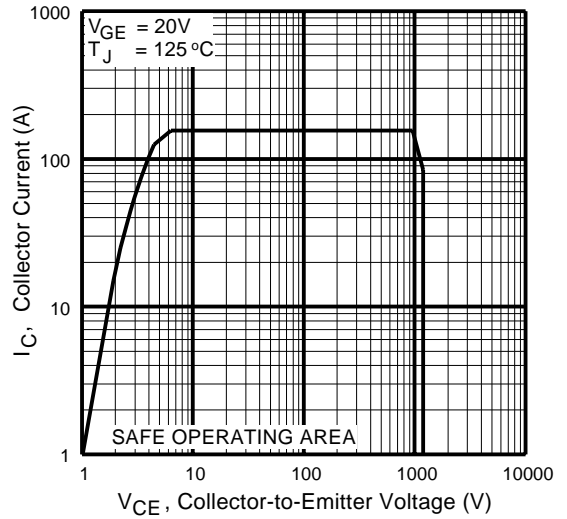

Fig. 12 - Turn-Off SOA

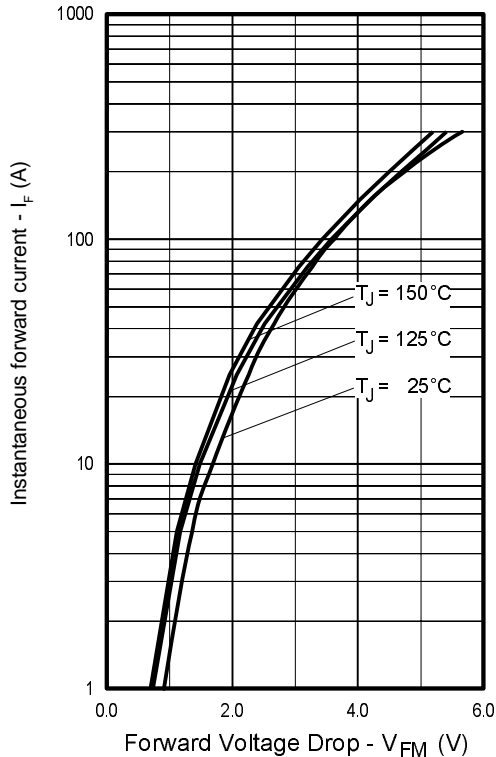

Fig. 13 - Typical Forward Voltage Drop vs. Instantaneous Forward Current

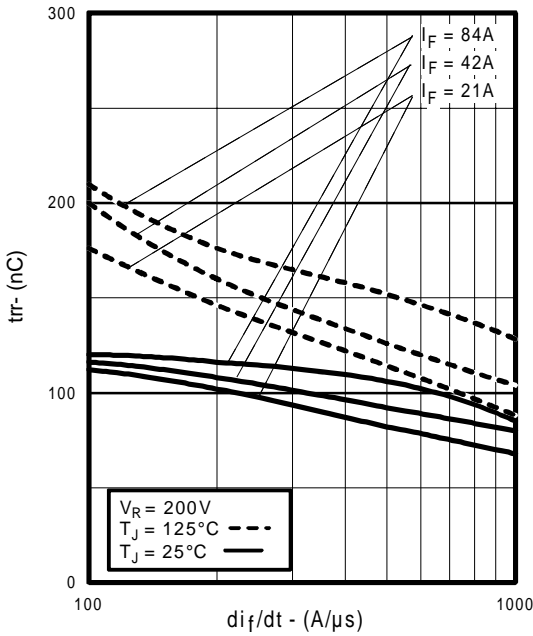

Fig. 14 - Typical Reverse Recovery vs. di_f/dt

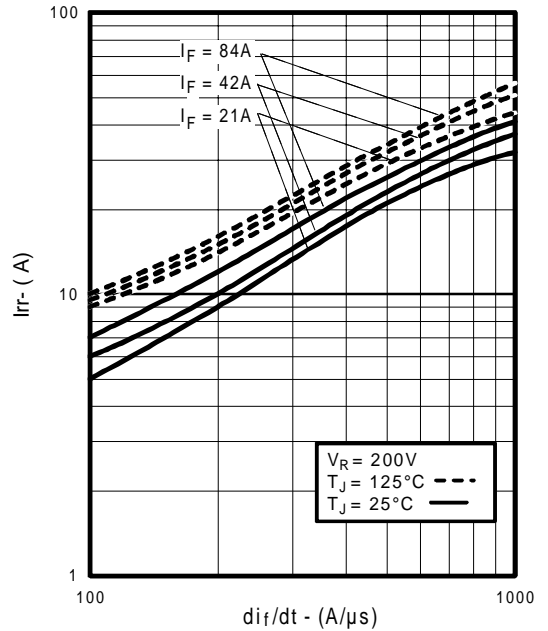

Fig. 15 - Typical Recovery Current vs. di_f/dt

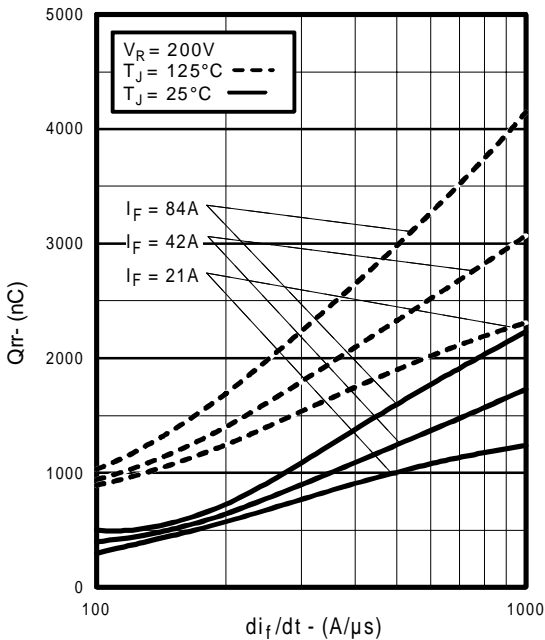

Fig. 16 - Typical Stored Charge vs. di_f/dt

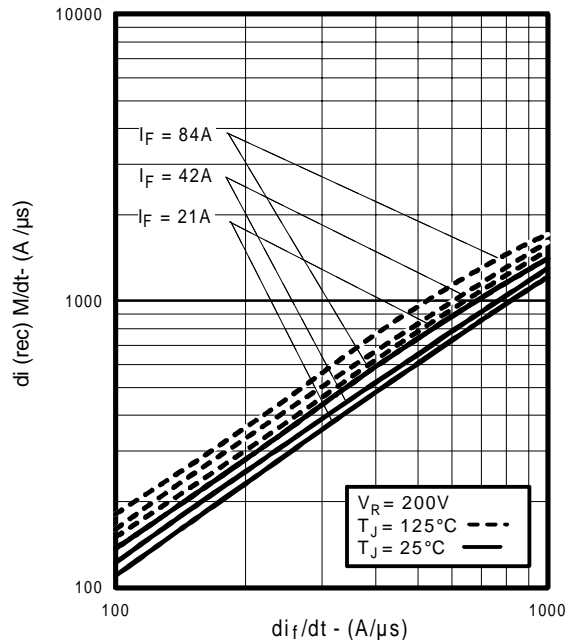

Fig. 17 - Typical $di_{(rec)}M/dt$ vs. di_f/dt

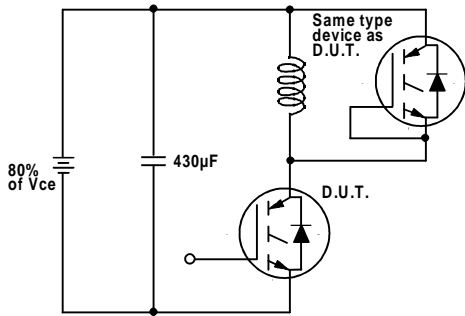

Fig. 18a - Test Circuit for Measurement of I_{LM} , E_{on} , $E_{off}(\text{diode})$, t_{rr} , Q_{rr} , I_{rr} , $t_{d(on)}$, t_r , $t_{d(off)}$, t_f

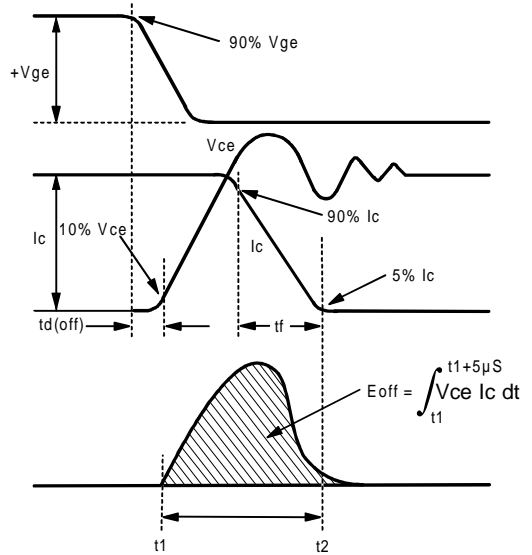

Fig. 18b - Test Waveforms for Circuit of Fig. 18a, Defining E_{off} , $t_{d(off)}$, t_f

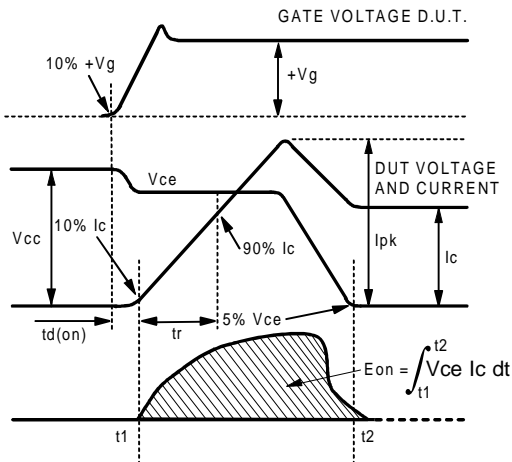

Fig. 18c - Test Waveforms for Circuit of Fig. 18a, Defining E_{on} , $t_{d(on)}$, t_r

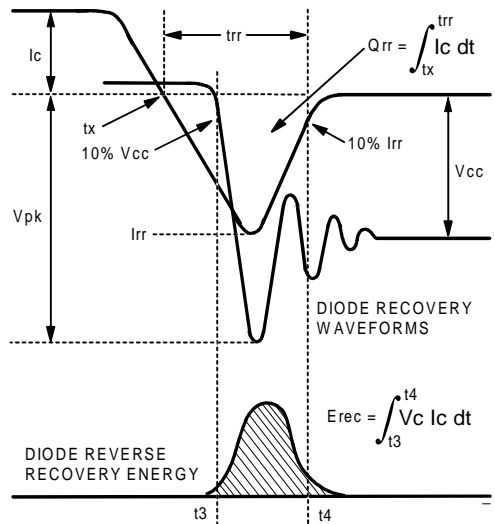

Fig. 18d - Test Waveforms for Circuit of Fig. 18a, Defining E_{rec} , t_{rr} , Q_{rr} , I_{rr}

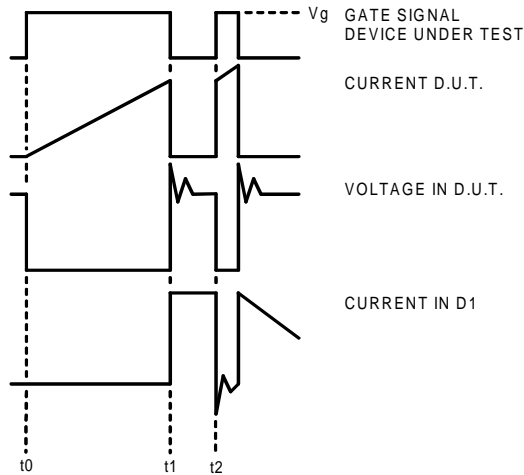

Figure 18e. Macro Waveforms for Figure 18a's Test Circuit

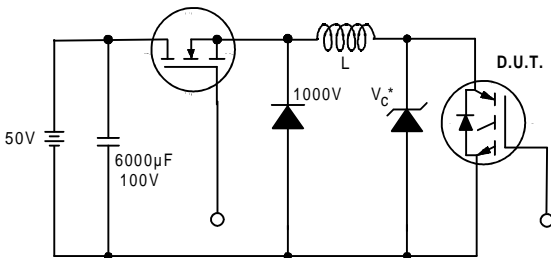

Figure 19. Clamped Inductive Load Test Circuit

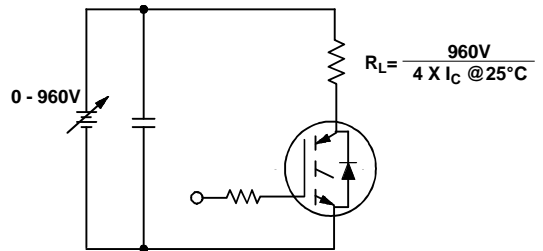

Figure 20. Pulsed Collector Current Test Circuit

Notes:

- ① Repetitive rating: $V_{GE}=20V$; pulse width limited by maximum junction temperature (figure 20)
- ② $V_{CC}=80\%(V_{CES})$, $V_{GE}=20V$, $L=10\mu H$, $R_G=5.0\Omega$ (figure 19)
- ③ Pulse width $\leq 80\mu s$; duty factor $\leq 0.1\%$
- ④ Pulse width $5.0\mu s$, single shot

Case Outline — SMD-10

Dimensions are shown in millimeters

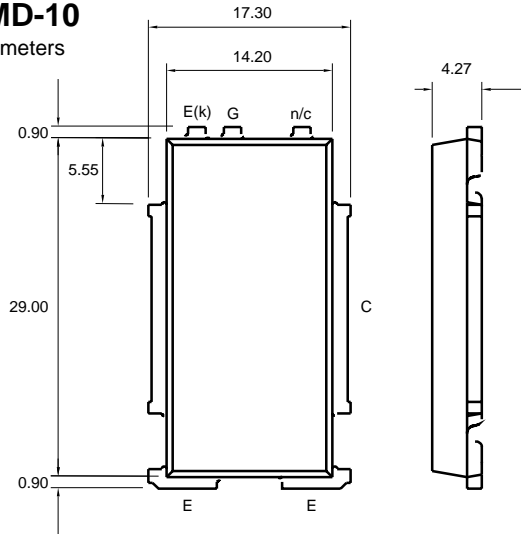

Recommended footprint

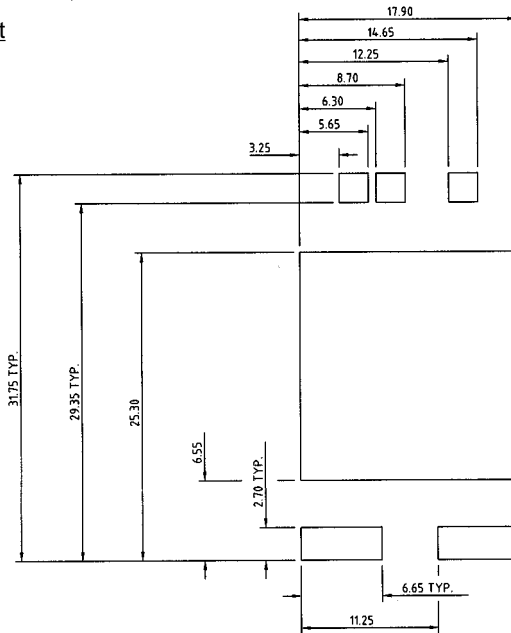

WORLD HEADQUARTERS: 233 Kansas St., El Segundo, California 90245, Tel: (310) 322 3331

EUROPEAN HEADQUARTERS: Hurst Green, Oxted, Surrey RH8 9BB, UK Tel: ++ 44 1883 732020

IR CANADA: 7321 Victoria Park Ave., Suite 201, Markham, Ontario L3R 2Z8, Tel: (905) 475 1897

IR GERMANY: Saalburgstrasse 157, 61350 Bad Homburg Tel: ++ 49 6172 96590

IR ITALY: Via Liguria 49, 10071 Borgaro, Torino Tel: ++ 39 11 451 0111

IR FAR EAST: K&H Bldg., 2F, 30-4 Nishi-Ikebukuro 3-Chome, Toshima-Ku, Tokyo Japan 171 Tel: 81 3 3983 0086

IR SOUTHEAST ASIA: 315 Outram Road, #10-02 Tan Boon Liat Building, Singapore 0316 Tel: 65 221 8371

<http://www.irf.com/> Data and specifications subject to change without notice. 5/98