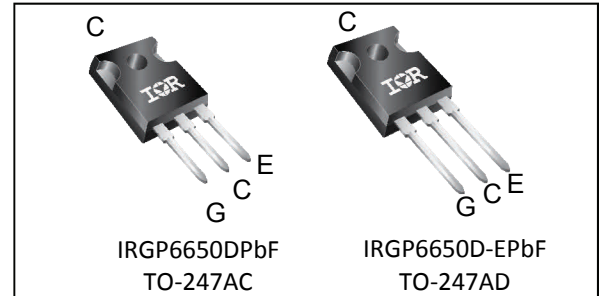
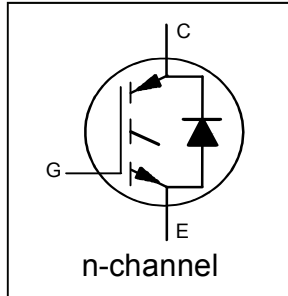


**Insulated Gate Bipolar Transistor with Ultrafast Soft Recovery Diode**

$V_{CES} = 600V$
$I_C = 50A, T_C = 100^{\circ}C$
$t_{SC} \geq 5\mu s, T_{J(max)} = 175^{\circ}C$
$V_{CE(ON)} \text{ typ.} = 1.65V @ I_C = 35A$



G	C	E
Gate	Collector	Emitter

**Applications**

- Welding
- H Bridge Converters

Features	Benefits
Low $V_{CE(ON)}$ and Switching Losses	High Efficiency in a Wide Range of Applications
Optimized Diode for Full Bridge Hard Switch Converters	Optimized for Welding and H Bridge Converters
Square RBSOA and Maximum Temperature of $175^{\circ}C$	Improved Reliability due to Rugged Hard Switching Performance and High Power Capability
$5\mu s$ Short Circuit	Enables Short Circuit Protection Operation
Positive $V_{CE(ON)}$ Temperature Co-efficient	Excellent Current Sharing in Parallel Operation
Lead-free, RoHS compliant	Environmentally friendly

Base part number	Package Type	Standard Pack		Orderable Part Number
		Form	Quantity	
IRGP6650DPbF	TO-247AC	Tube	25	IRGP6650DPbF
IRGP6650D-EPbF	TO-247AD	Tube	25	IRGP6650D-EPbF

**Absolute Maximum Ratings**

	Parameter	Max.	Units
$V_{CES}$	Collector-to-Emitter Voltage	600	V
$I_C @ T_C = 25^{\circ}C$	Continuous Collector Current	80	A
$I_C @ T_C = 100^{\circ}C$	Continuous Collector Current	50	
$I_{CM}$	Pulse Collector Current, $V_{GE} = 15V$	105	
$I_{LM}$	Clamped Inductive Load Current, $V_{GE} = 20V$ ①	140	
$I_{FRM} @ T_C = 100^{\circ}C$	Diode Repetitive Peak Forward Current④⑥	25	
$I_{FM}$	Diode Maximum Forward Current ④	140	W
$V_{GE}$	Continuous Gate-to-Emitter Voltage	$\pm 20$	
$P_D @ T_C = 25^{\circ}C$	Maximum Power Dissipation	306	W
$P_D @ T_C = 100^{\circ}C$	Maximum Power Dissipation	153	
$T_J$ $T_{STG}$	Operating Junction and Storage Temperature Range	-40 to +175	$^{\circ}C$
	Soldering Temperature, for 10 sec.	300 (0.063 in. (1.6mm) from case)	
	Mounting Torque, 6-32 or M3 Screw	10 lbf·in (1.1 N·m)	

**Thermal Resistance**

	Parameter	Min.	Typ.	Max.	Units
$R_{\theta JC}$ (IGBT)	Thermal Resistance Junction-to-Case-(each IGBT) ②	—	—	0.49	$^{\circ}C/W$
$R_{\theta JC}$ (Diode)	Thermal Resistance Junction-to-Case-(each Diode) ②	—	—	3.35	
$R_{\theta CS}$	Thermal Resistance, Case-to-Sink (flat, greased surface)	—	0.24	—	
$R_{\theta JA}$	Thermal Resistance, Junction-to-Ambient (typical socket mount)	—	—	40	

**Electrical Characteristics @ T<sub>J</sub> = 25°C (unless otherwise specified)**

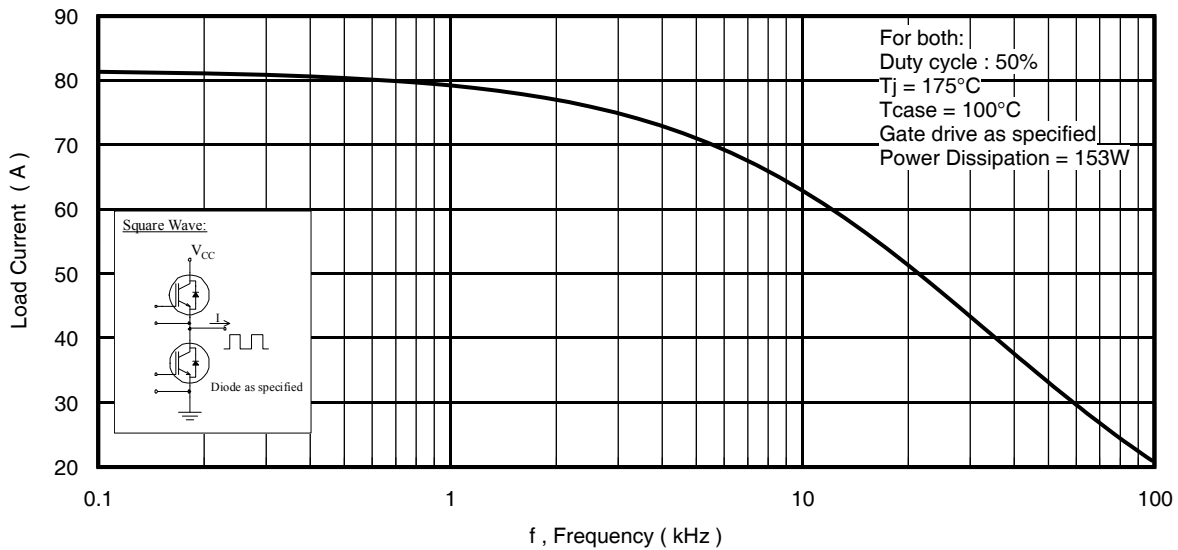
	Parameter	Min.	Typ.	Max.	Units	Conditions
V <sub>(BR)CES</sub>	Collector-to-Emitter Breakdown Voltage	600	—	—	V	V <sub>GE</sub> = 0V, I <sub>C</sub> = 100μA ③
ΔV <sub>(BR)CES</sub> /ΔT <sub>J</sub>	Temperature Coeff. of Breakdown Voltage	—	0.45	—	V/°C	V <sub>GE</sub> = 0V, I <sub>C</sub> = 1.0mA (25°C-175°C)
V <sub>CE(on)</sub>	Collector-to-Emitter Saturation Voltage	—	1.65	1.95	V	I <sub>C</sub> = 35A, V <sub>GE</sub> = 15V, T <sub>J</sub> = 25°C
		—	2.05	—		I <sub>C</sub> = 35A, V <sub>GE</sub> = 15V, T <sub>J</sub> = 150°C
		—	2.10	—		I <sub>C</sub> = 35A, V <sub>GE</sub> = 15V, T <sub>J</sub> = 175°C
V <sub>GE(th)</sub>	Gate Threshold Voltage	4.0	—	6.5	V	V <sub>CE</sub> = V <sub>GE</sub> , I <sub>C</sub> = 1.0mA
ΔV <sub>GE(th)</sub> /ΔT <sub>J</sub>	Threshold Voltage Temperature Coeff.	—	-18	—	mV/°C	V <sub>CE</sub> = V <sub>GE</sub> , I <sub>C</sub> = 1.0mA (25°C-175°C)
g <sub>fe</sub>	Forward Transconductance	—	22	—	S	V <sub>CE</sub> = 50V, I <sub>C</sub> = 35A, PW = 20μs
I <sub>CES</sub>	Collector-to-Emitter Leakage Current	—	1.0	50	μA	V <sub>GE</sub> = 0V, V <sub>CE</sub> = 600V
		—	600	—		V <sub>GE</sub> = 0V, V <sub>CE</sub> = 600V, T <sub>J</sub> = 175°C
I <sub>GES</sub>	Gate-to-Emitter Leakage Current	—	—	±100	nA	V <sub>GE</sub> = ±20V
V <sub>F</sub>	Diode Forward Voltage Drop	—	1.80	2.80	V	I <sub>F</sub> = 8A
		—	1.30	—		I <sub>F</sub> = 8A, T <sub>J</sub> = 175°C

**Switching Characteristics @ T<sub>J</sub> = 25°C (unless otherwise specified)**

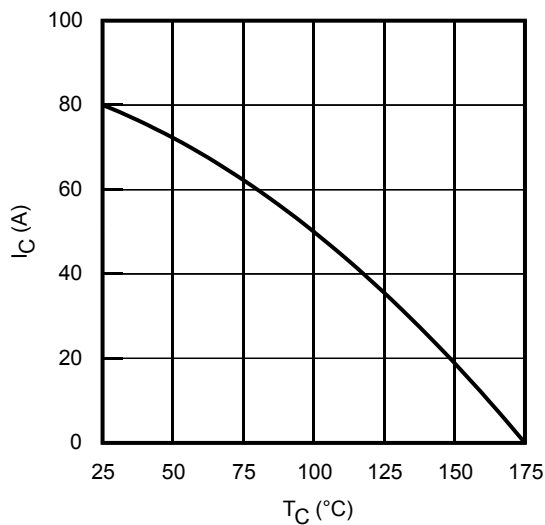
	Parameter	Min.	Typ.	Max	Units	Conditions
Q <sub>g</sub>	Total Gate Charge (turn-on)	—	75	—	nC	I <sub>C</sub> = 35A V <sub>GE</sub> = 15V V <sub>CC</sub> = 400V
Q <sub>ge</sub>	Gate-to-Emitter Charge (turn-on)	—	20	—		
Q <sub>gc</sub>	Gate-to-Collector Charge (turn-on)	—	30	—		
E <sub>on</sub>	Turn-On Switching Loss	—	300	—	μJ	I <sub>C</sub> = 35A, V <sub>CC</sub> = 400V, V <sub>GE</sub> =15V R <sub>G</sub> = 10Ω, L=210μH, T <sub>J</sub> = 25°C
E <sub>off</sub>	Turn-Off Switching Loss	—	630	—		
E <sub>total</sub>	Total Switching Loss	—	930	—		
t <sub>d(on)</sub>	Turn-On delay time	—	40	—	ns	Energy losses include tail & diode reverse recovery ⑤
t <sub>r</sub>	Rise time	—	30	—		
t <sub>d(off)</sub>	Turn-Off delay time	—	105	—		
t <sub>f</sub>	Fall time	—	20	—		
E <sub>on</sub>	Turn-On Switching Loss	—	640	—		
E <sub>off</sub>	Turn-Off Switching Loss	—	930	—	μJ	I <sub>C</sub> = 35A, V <sub>CC</sub> = 400V, V <sub>GE</sub> =15V R <sub>G</sub> = 10Ω, L=210μH, T <sub>J</sub> = 175°C
E <sub>total</sub>	Total Switching Loss	—	1570	—		
t <sub>d(on)</sub>	Turn-On delay time	—	40	—		
t <sub>r</sub>	Rise time	—	30	—	ns	Energy losses include tail & diode reverse recovery ⑤
t <sub>d(off)</sub>	Turn-Off delay time	—	120	—		
t <sub>f</sub>	Fall time	—	60	—		
C <sub>ies</sub>	Input Capacitance	—	2220	—	pF	V <sub>GE</sub> = 0V V <sub>CC</sub> = 30V f = 1.0MHz
C <sub>oes</sub>	Output Capacitance	—	130	—		
C <sub>res</sub>	Reverse Transfer Capacitance	—	65	—		
RBSOA	Reverse Bias Safe Operating Area	FULL SQUARE				T <sub>J</sub> = 175°C, I <sub>C</sub> = 140A V <sub>CC</sub> = 480V, V <sub>p</sub> ≤ 600V V <sub>GE</sub> = +20V to 0V
SCSOA	Short Circuit Safe Operating Area	5	—	—	μs	T <sub>J</sub> = 150°C, V <sub>CC</sub> = 400V, V <sub>p</sub> ≤ 600V V <sub>GE</sub> = +15V to 0V
E <sub>rec</sub>	Reverse Recovery Energy of the Diode	—	165	—	μJ	T <sub>J</sub> = 175°C
t <sub>rr</sub>	Diode Reverse Recovery Time	—	50	—	ns	V <sub>CC</sub> = 400V, I <sub>F</sub> = 8A, V <sub>GE</sub> = 15V
I <sub>rr</sub>	Peak Reverse Recovery Current	—	14	—	A	R <sub>g</sub> = 22Ω, L=1.0mH, L <sub>s</sub> =150nH

**Notes:**

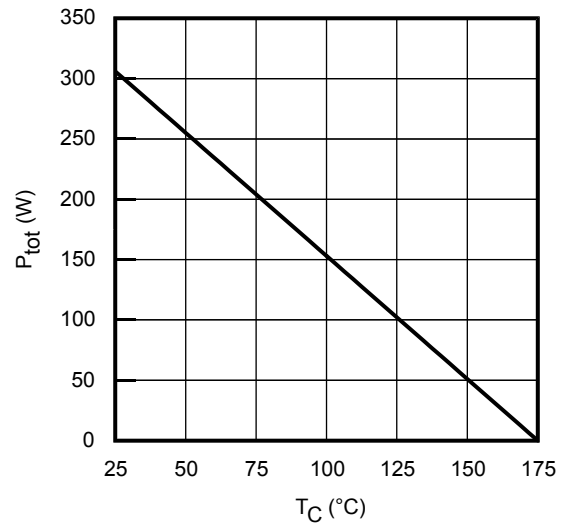
- ① V<sub>CC</sub> = 80% (V<sub>CES</sub>), V<sub>GE</sub> = 20V, R<sub>G</sub> = 10Ω, L=210μH.
- ② R<sub>θ</sub> is measured at T<sub>J</sub> of approximately 90°C.
- ③ Refer to AN-1086 for guidelines for measuring V<sub>(BR)CES</sub> safely.
- ④ Pulse width limited by max. junction temperature.
- ⑤ Values influenced by parasitic L and C in measurement.
- ⑥ f<sub>sw</sub> = 40KHz, refer to figure 26.



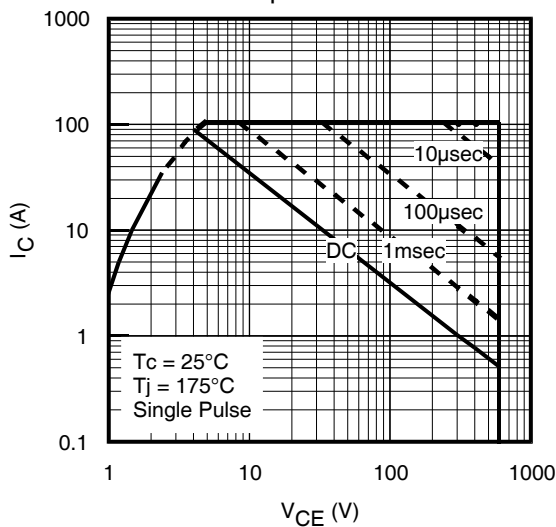
**Fig. 1 - Typical Load Current vs. Frequency**  
(Load Current =  $I_{RMS}$  of fundamental)



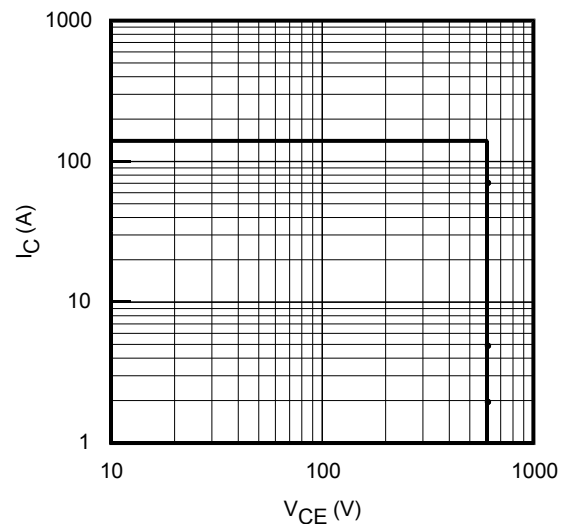
**Fig. 2 - Maximum DC Collector Current vs. Case Temperature**



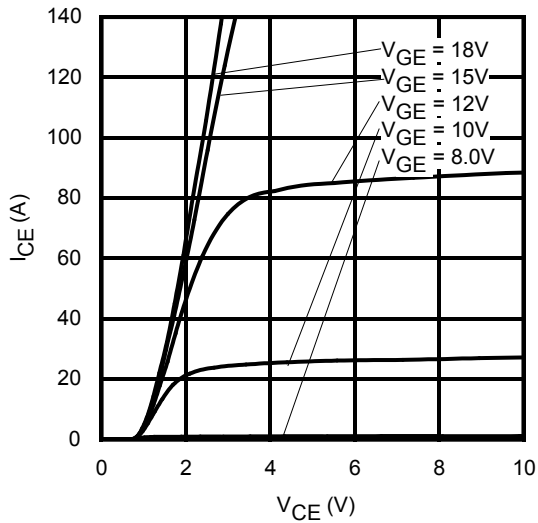
**Fig. 3 - Power Dissipation vs. Case Temperature**



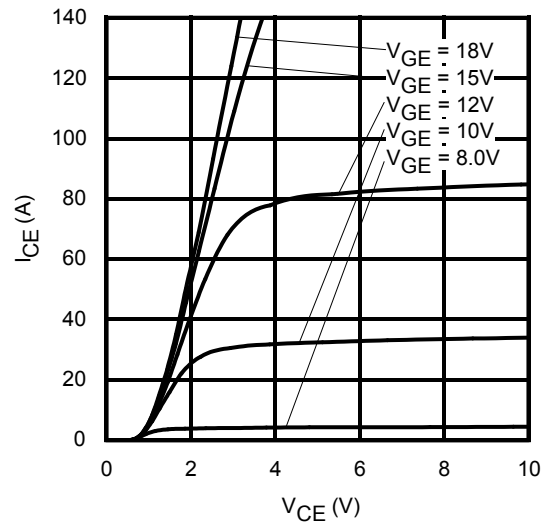
**Fig. 4 - Forward SOA**  
 $T_C = 25^\circ\text{C}$ ;  $T_J \leq 175^\circ\text{C}$ ;  $V_{GE} = 15\text{V}$



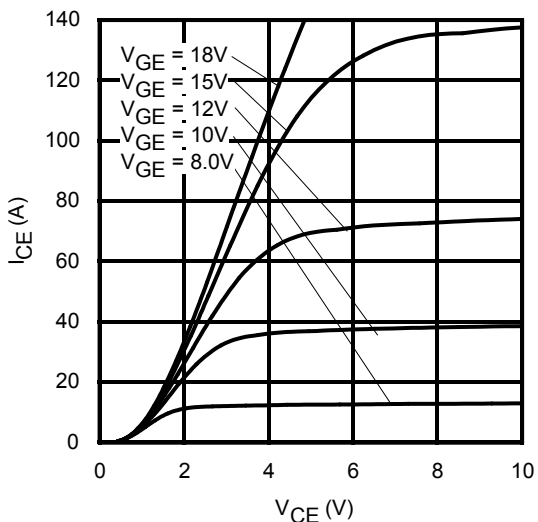
**Fig. 5 - Reverse Bias SOA**  
 $T_J = 175^\circ\text{C}$ ;  $V_{GE} = 20\text{V}$



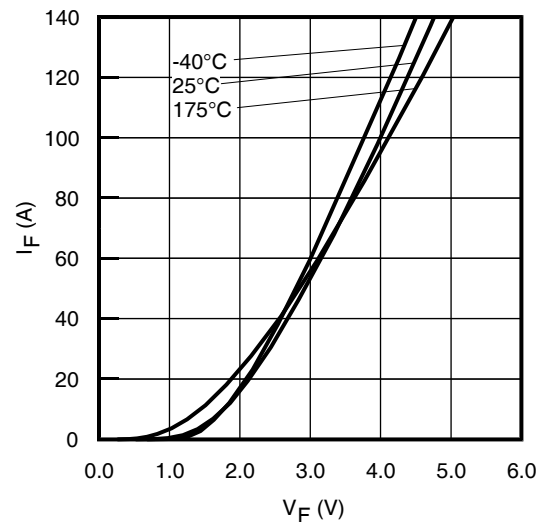
**Fig. 6 - Typ. IGBT Output Characteristics**  
 $T_J = -40^\circ\text{C}$ ;  $t_p = 20\mu\text{s}$



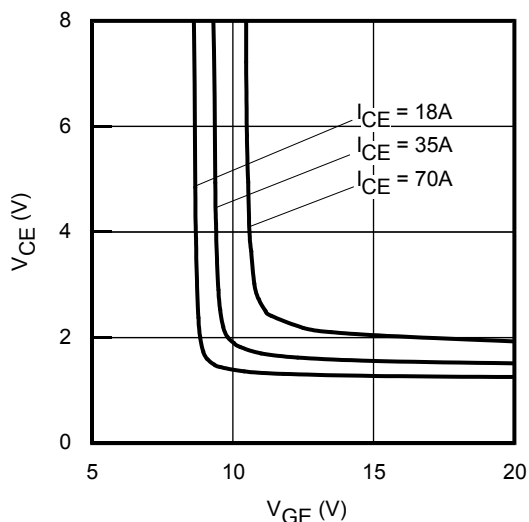
**Fig. 7 - Typ. IGBT Output Characteristics**  
 $T_J = 25^\circ\text{C}$ ;  $t_p = 20\mu\text{s}$



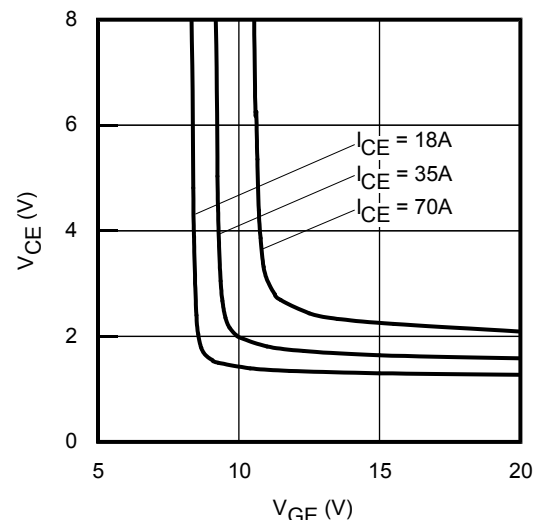
**Fig. 8 - Typ. IGBT Output Characteristics**  
 $T_J = 175^\circ\text{C}$ ;  $t_p = 20\mu\text{s}$



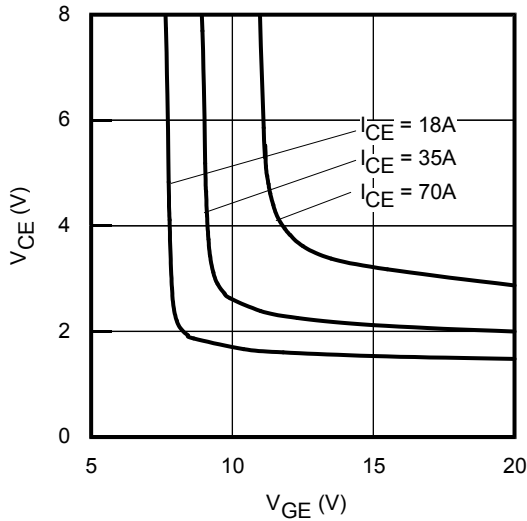
**Fig. 9 - Typ. Diode Forward Voltage Drop Characteristics**



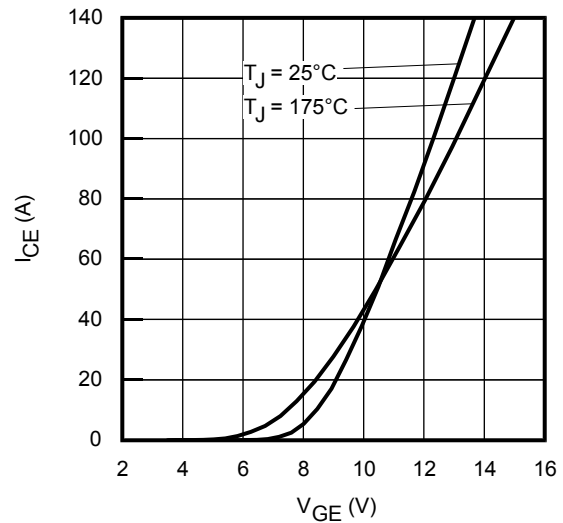
**Fig. 10 - Typical  $V_{CE}$  vs.  $V_{GE}$**   
 $T_J = -40^\circ\text{C}$



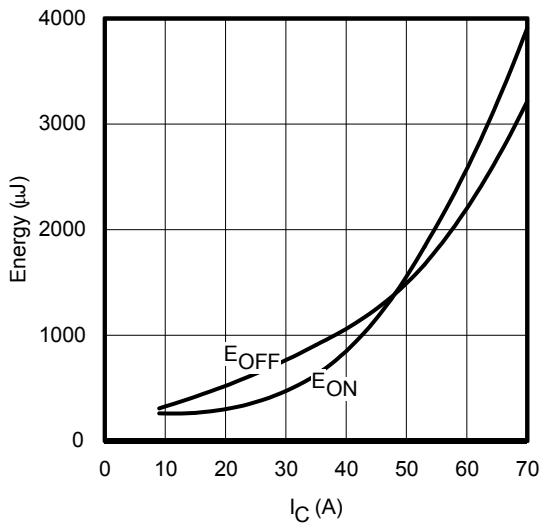
**Fig. 11 - Typical  $V_{CE}$  vs.  $V_{GE}$**   
 $T_J = 25^\circ\text{C}$



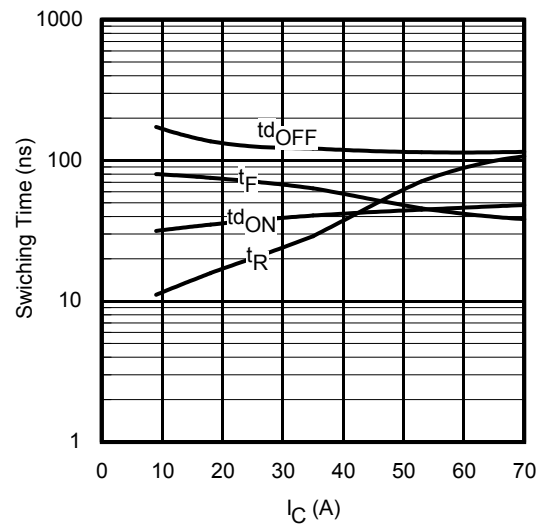
**Fig. 12** - Typical  $V_{CE}$  vs.  $V_{GE}$   
 $T_J = 175^\circ\text{C}$



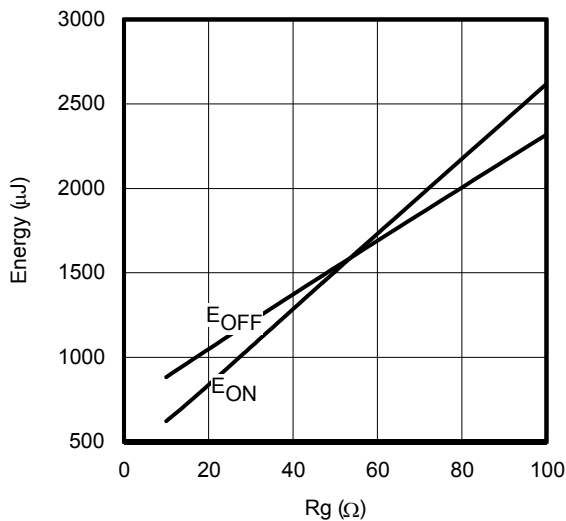
**Fig. 13** - Typ. Transfer Characteristics  
 $V_{CE} = 50\text{V}$ ;  $t_p = 20\mu\text{s}$



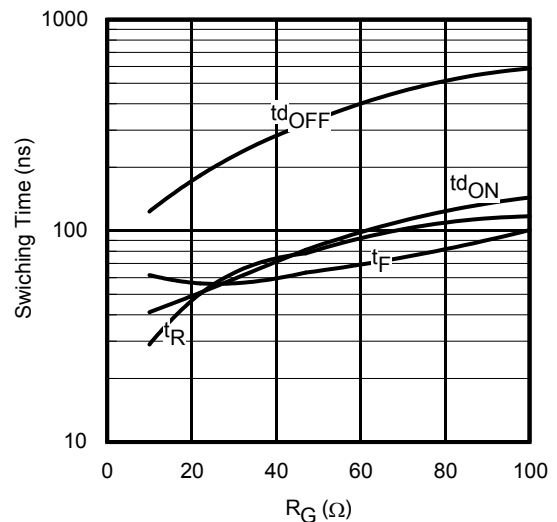
**Fig. 14** - Typ. Energy Loss vs.  $I_C$   
 $T_J = 175^\circ\text{C}$ ;  $V_{CE} = 400\text{V}$ ,  $R_G = 10\Omega$ ;  $V_{GE} = 15\text{V}$



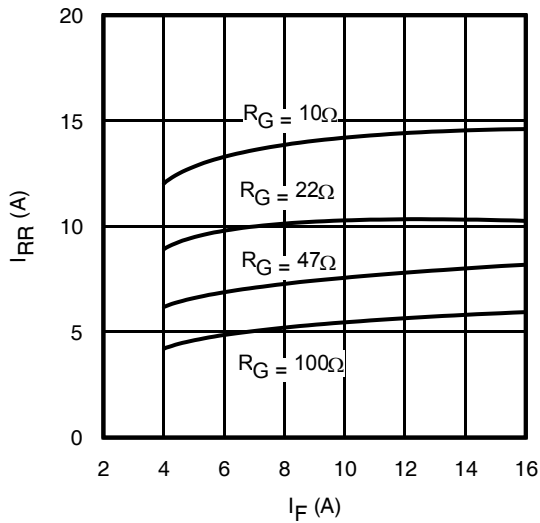
**Fig. 15** - Typ. Switching Time vs.  $I_C$   
 $T_J = 175^\circ\text{C}$ ;  $V_{CE} = 400\text{V}$ ,  $R_G = 10\Omega$ ;  $V_{GE} = 15\text{V}$



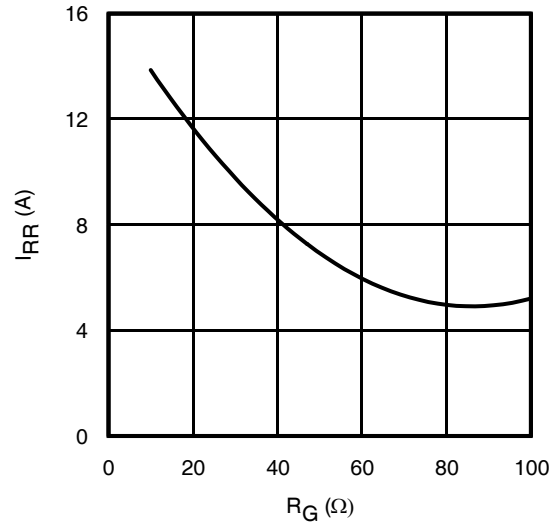
**Fig. 16** - Typ. Energy Loss vs.  $R_G$   
 $T_J = 175^\circ\text{C}$ ;  $V_{CE} = 400\text{V}$ ,  $I_{CE} = 35\text{A}$ ;  $V_{GE} = 15\text{V}$



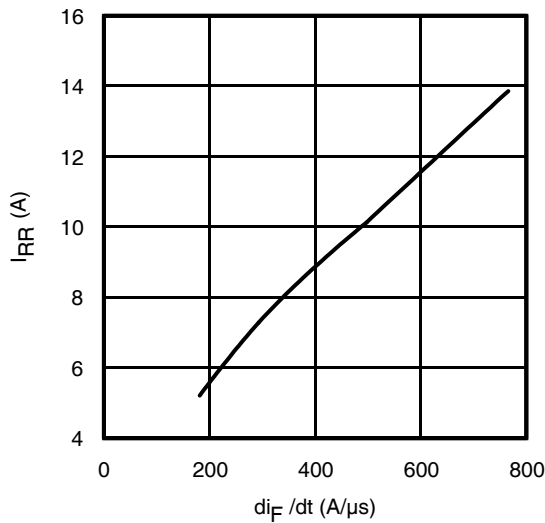
**Fig. 17** - Typ. Switching Time vs.  $R_G$   
 $T_J = 175^\circ\text{C}$ ;  $V_{CE} = 400\text{V}$ ,  $I_{CE} = 35\text{A}$ ;  $V_{GE} = 15\text{V}$



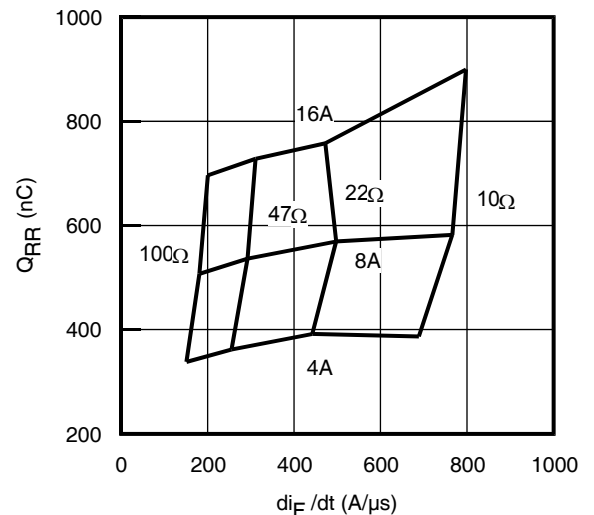
**Fig. 18** - Typ. Diode  $I_{RR}$  vs.  $I_F$   
 $T_J = 175^\circ\text{C}$



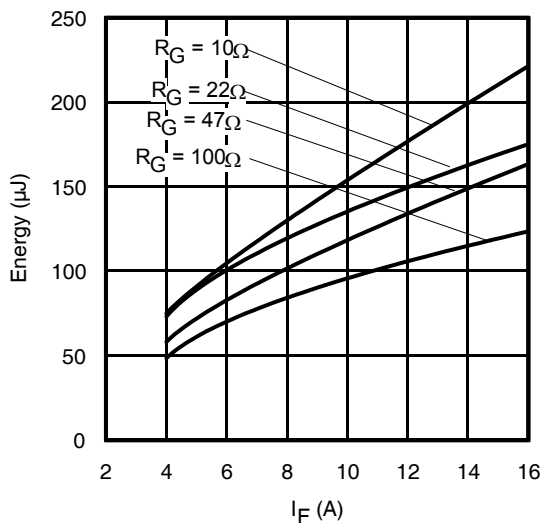
**Fig. 19** - Typ. Diode  $I_{RR}$  vs.  $R_G$   
 $T_J = 175^\circ\text{C}$



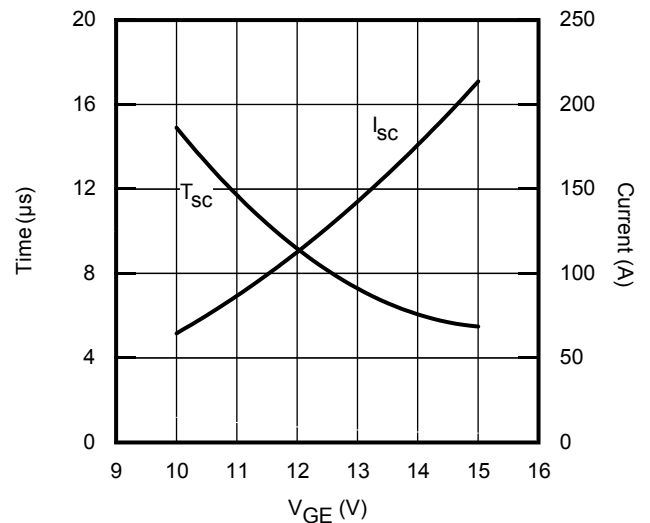
**Fig. 20** - Typ. Diode  $I_{RR}$  vs.  $di_F/dt$   
 $V_{CC} = 400\text{V}$ ;  $V_{GE} = 15\text{V}$ ;  $I_F = 8\text{A}$ ;  $T_J = 175^\circ\text{C}$



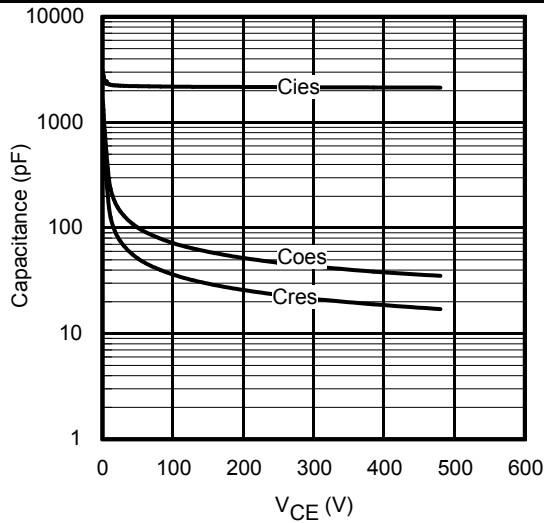
**Fig. 21** - Typ. Diode  $Q_{RR}$  vs.  $di_F/dt$   
 $V_{CC} = 400\text{V}$ ;  $V_{GE} = 15\text{V}$ ;  $T_J = 175^\circ\text{C}$



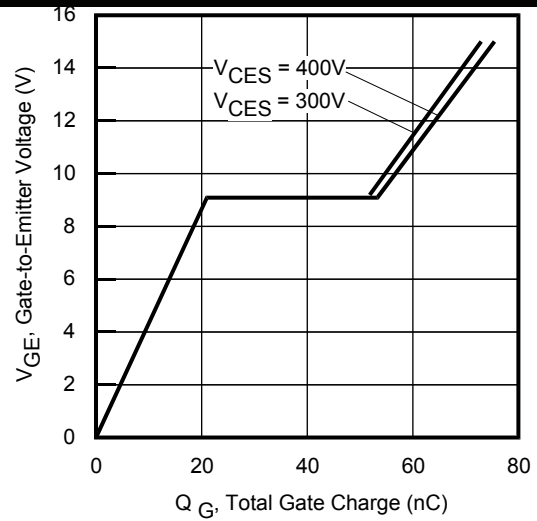
**Fig. 22** - Typ. Diode  $E_{RR}$  vs.  $I_F$   
 $T_J = 175^\circ\text{C}$



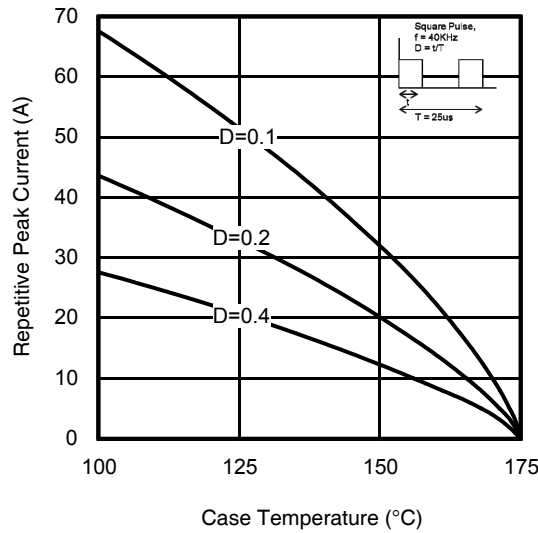
**Fig. 23** -  $V_{GE}$  vs. Short Circuit Time  
 $V_{CC} = 400\text{V}$ ;  $T_C = 150^\circ\text{C}$



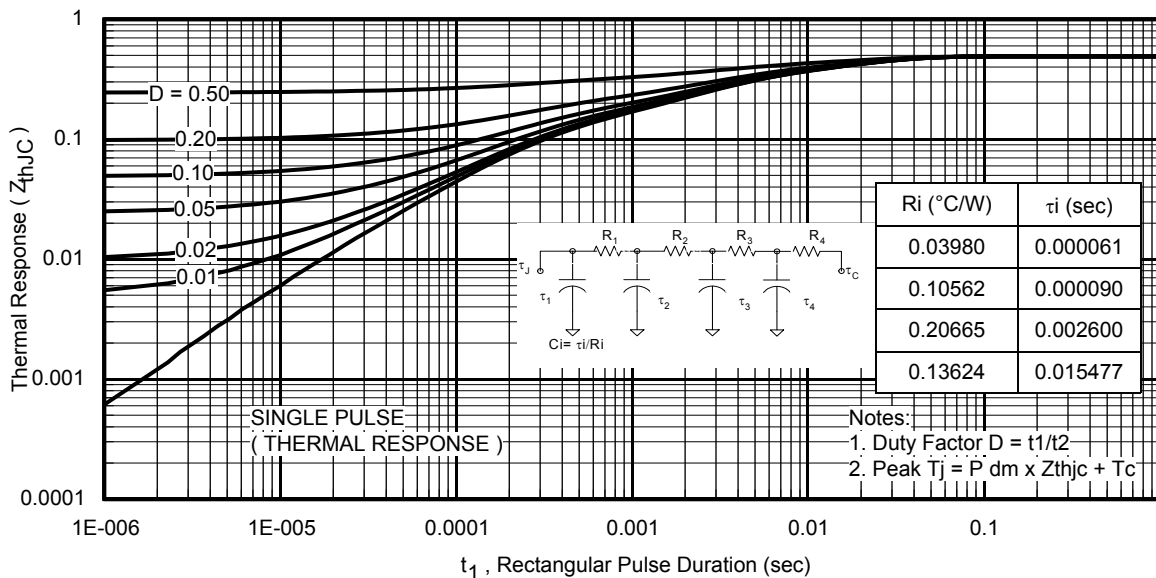
**Fig. 24** - Typ. Capacitance vs.  $V_{CE}$   
 $V_{GE} = 0V$ ;  $f = 1MHz$



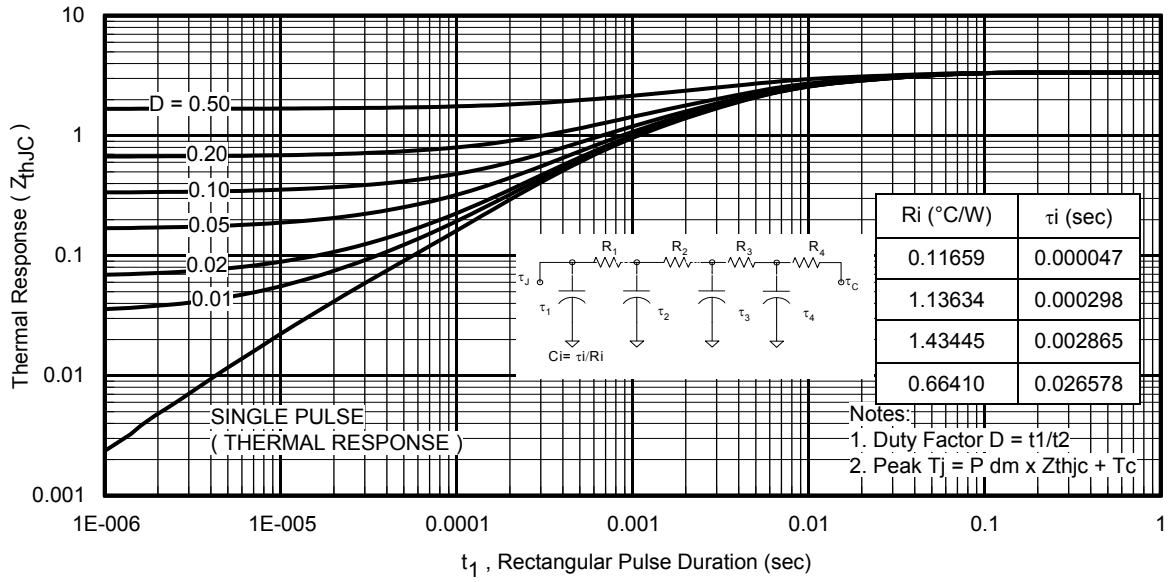
**Fig. 25** - Typical Gate Charge vs.  $V_{GE}$   
 $I_{CE} = 35A$



**Fig. 26.** Maximum Diode Repetitive Forward Peak Current vs. Case Temperature

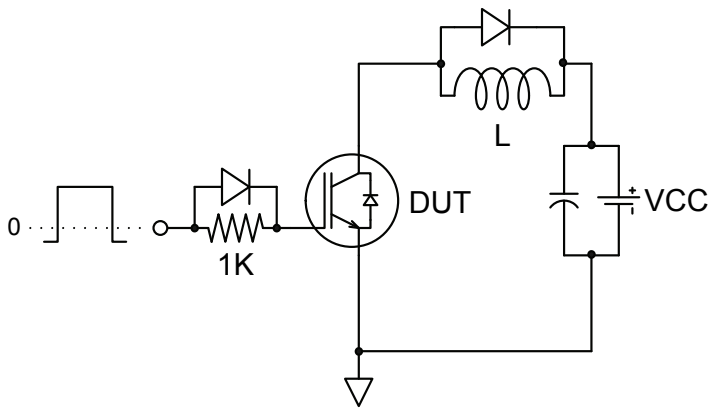


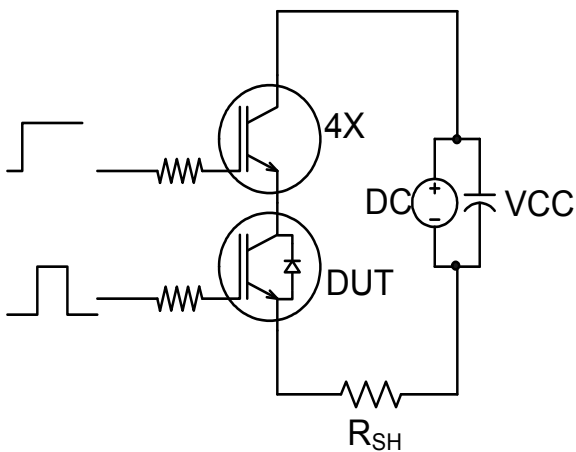
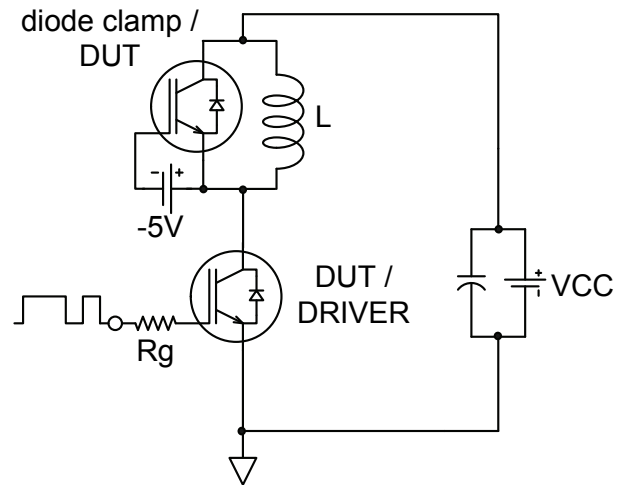
**Fig. 27** - Maximum Transient Thermal Impedance, Junction-to-Case (IGBT)



**Fig. 28 - Maximum Transient Thermal Impedance, Junction-to-Case (DIODE)**

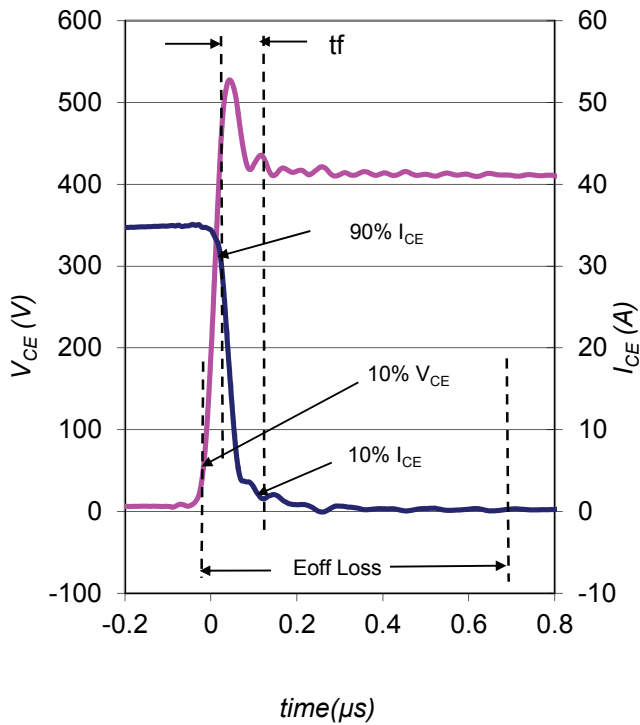



**Fig.C.T.1 - Gate Charge Circuit (turn-off)**

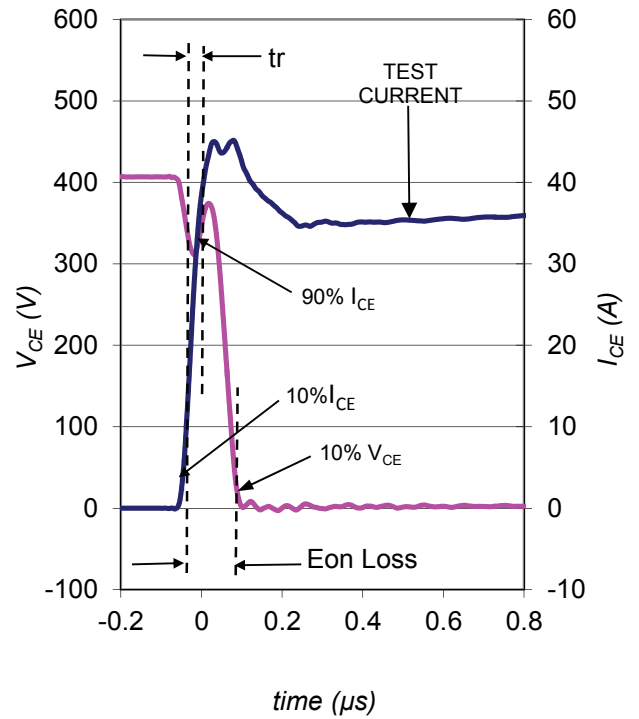
**Fig.C.T.2 - RBSOA Circuit**

**Fig.C.T.3 - S.C. SOA Circuit**

**Fig.C.T.4 - Switching Loss Circuit**

**Fig.C.T.5 - Resistive Load Circuit**

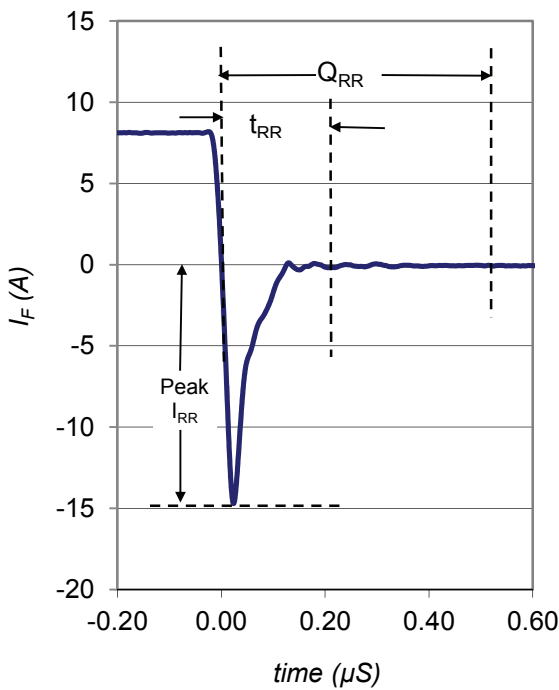
**Fig.C.T.6 - BVCES Filter Circuit**



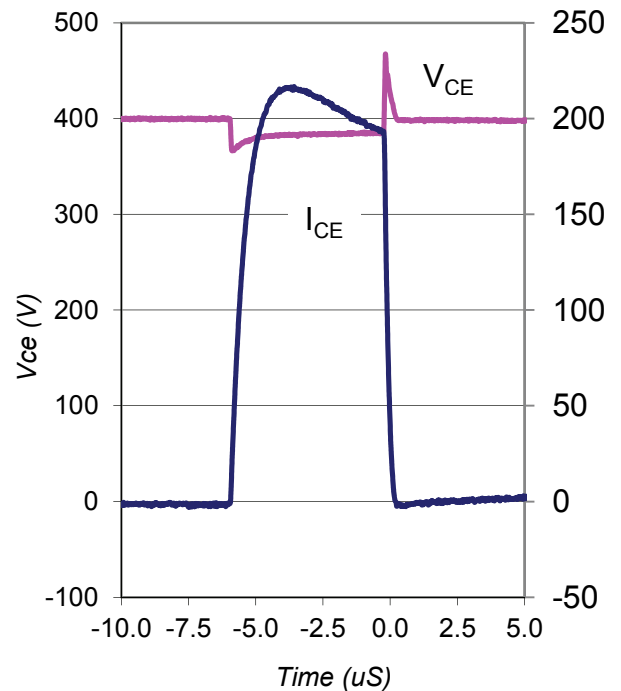
**Fig. WF1** - Typ. Turn-off Loss Waveform  
@  $T_J = 175^\circ\text{C}$  using Fig. CT.4



**Fig. WF2** - Typ. Turn-on Loss Waveform  
@  $T_J = 175^\circ\text{C}$  using Fig. CT.4



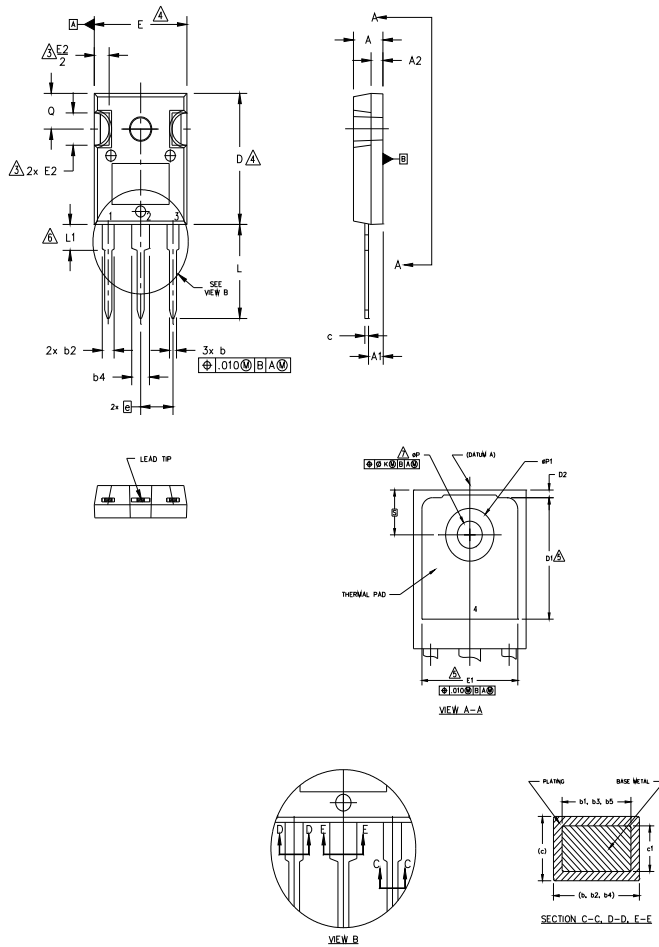
**Fig. WF3** - Typ. Diode Recovery Waveform  
@  $T_J = 175^\circ\text{C}$  using Fig. CT.4



**Fig. WF4** - Typ. S.C. Waveform  
@  $T_J = 150^\circ\text{C}$  using Fig. CT.3

## TO-247AC Package Outline

Dimensions are shown in millimeters (inches)



**NOTES:**

1. DIMENSIONING AND TOLERANCING AS PER ASME Y14.5M 1994.
2. DIMENSIONS ARE SHOWN IN INCHES.
3. CONTOUR OF SLOT OPTIONAL.
4. DIMENSION D & E DO NOT INCLUDE MOLD FLASH. MOLD FLASH SHALL NOT EXCEED .005" (0.127) PER SIDE. THESE DIMENSIONS ARE MEASURED AT THE OUTERMOST EXTREMES OF THE PLASTIC BODY.
5. THERMAL PAD CONTOUR OPTIONAL WITHIN DIMENSIONS D1 & E1.
6. LEAD FINISH UNCONTROLLED IN L1.
7. ØP TO HAVE A MAXIMUM DRAFT ANGLE OF 1.5 ° TO THE TOP OF THE PART WITH A MAXIMUM HOLE DIAMETER OF .154 INCH.
8. OUTLINE CONFORMS TO JEDEC OUTLINE TO-247AC .

SYMBOL	DIMENSIONS				NOTES
	INCHES		MILLIMETERS		
	MIN.	MAX.	MIN.	MAX.	
A	.183	.209	4.65	5.31	
A1	.087	.102	2.21	2.59	
A2	.059	.098	1.50	2.49	
b	.039	.055	0.99	1.40	
b1	.039	.053	0.99	1.35	
b2	.065	.094	1.65	2.39	
b3	.065	.092	1.65	2.34	
b4	.102	.135	2.59	3.43	
b5	.102	.133	2.59	3.38	
c	.015	.035	0.38	0.89	
c1	.015	.033	0.38	0.84	
D	.776	.815	19.71	20.70	4
D1	.515	-	13.08	-	5
D2	.020	.053	0.51	1.35	
E	.602	.625	15.29	15.87	4
E1	.530	-	13.46	-	
E2	.178	.216	4.52	5.49	
e	.215 BSC		5.46 BSC		
Øk	.010		0.25		
L	.559	.634	14.20	16.10	
L1	.146	.169	3.71	4.29	
ØP	.140	.144	3.56	3.66	
ØP1	-	.291	-	7.39	
Q	.209	.224	5.31	5.69	
S	.217 BSC		5.51 BSC		

LEAD ASSIGNMENTS

HEXFET

- 1.- GATE
- 2.- DRAIN
- 3.- SOURCE
- 4.- DRAIN

IGBTs, CoPACK

- 1.- GATE
- 2.- COLLECTOR
- 3.- EMITTER
- 4.- COLLECTOR

DIODES

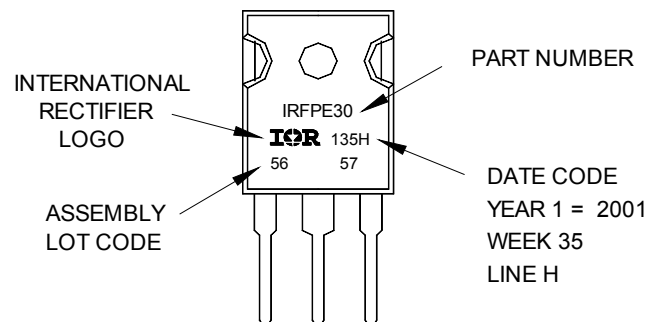
- 1.- ANODE/OPEN
- 2.- CATHODE
- 3.- ANODE

## TO-247AC Part Marking Information

Notes: This part marking information applies to devices produced after 02/26/2001

EXAMPLE: THIS IS AN IRFPE30  
WITH ASSEMBLY  
LOT CODE 5657  
ASSEMBLED ON WW 35, 2001  
IN THE ASSEMBLY LINE "H"

Note: "P" in assembly line position  
indicates "Lead-Free"

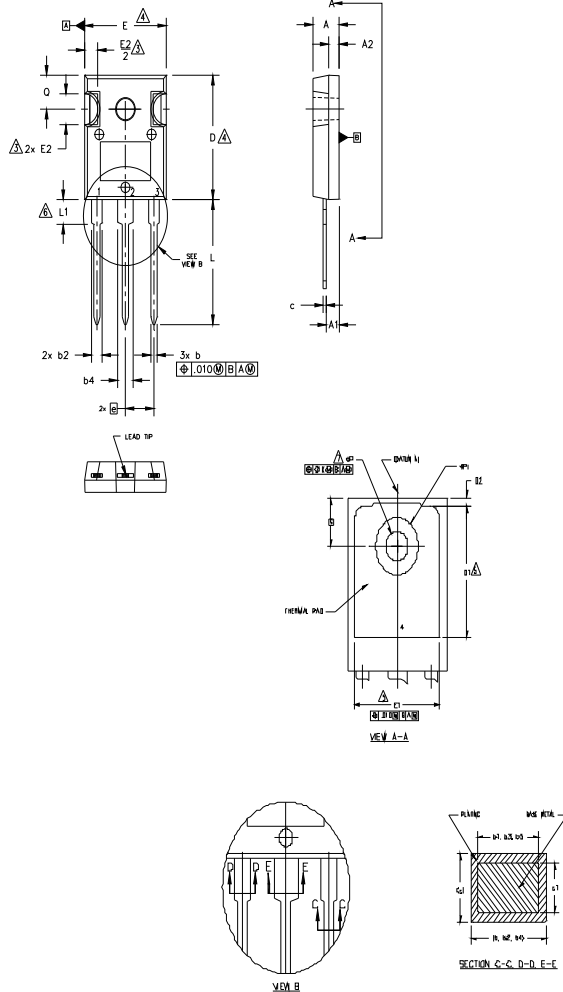


TO-247AC package is not recommended for Surface Mount Application.

Note: For the most current drawing please refer to IR website at <http://www.irf.com/package/>

## TO-247AD Package Outline

Dimensions are shown in millimeters (inches)



NOTES:

1. DIMENSIONING AND TOLERANCING AS PER ASME Y14.5M 1994.
2. DIMENSIONS ARE SHOWN IN INCHES.
3. CONTOUR OF SLOT OPTIONAL.
4. DIMENSION D & E DO NOT INCLUDE MOLD FLASH. MOLD FLASH SHALL NOT EXCEED .005" (0.127) PER SIDE. THESE DIMENSIONS ARE MEASURED AT THE OUTERMOST EXTREMES OF THE PLASTIC BODY.
5. THERMAL PAD CONTOUR OPTIONAL WITHIN DIMENSIONS D1 & E1.
6. LEAD FINISH UNCONTROLLED IN L1.
7. ØP TO HAVE A MAXIMUM DRAFT ANGLE OF 1.5 ° TO THE TOP OF THE PART WITH A MAXIMUM HOLE DIAMETER OF .154 INCH.
8. OUTLINE CONFORMS TO JEDEC OUTLINE TO-247AD.

SYMBOL	DIMENSIONS				NOTES
	INCHES		MILLIMETERS		
	MIN.	MAX.	MIN.	MAX.	
A	.183	.209	4.65	5.31	
A1	.087	.102	2.21	2.59	
A2	.059	.098	1.50	2.49	
b	.039	.056	0.99	1.40	
b1	.039	.053	0.99	1.36	
b2	.065	.094	1.65	2.39	
b3	.065	.092	1.65	2.34	
b4	.102	.135	2.59	3.43	
b5	.102	.133	2.59	3.38	
c	.015	.036	0.38	0.89	
c1	.015	.033	0.38	0.84	
D	.776	.815	19.71	20.70	4
D1	.515	-	13.08	-	5
D2	.020	.053	0.51	1.36	
E	.602	.625	15.29	15.87	4
E1	.530	-	13.46	-	
E2	.178	.216	4.52	5.49	
e	.215 BSC		5.46 BSC		
Øk	.010		0.25		
L	.780	.827	19.57	21.00	
L1	.146	.169	3.71	4.29	
ØP	.140	.144	3.56	3.66	
ØP1	-	.291	-	7.39	
Q	.209	.224	5.31	5.69	
S	.217 BSC		5.51 BSC		

LEAD ASSIGNMENTS

HEXFET

- 1.- GATE
- 2.- DRAIN
- 3.- SOURCE
- 4.- DRAIN

IGBTs, CgPACK

- 1.- GATE
- 2.- COLLECTOR
- 3.- EMITTER
- 4.- COLLECTOR

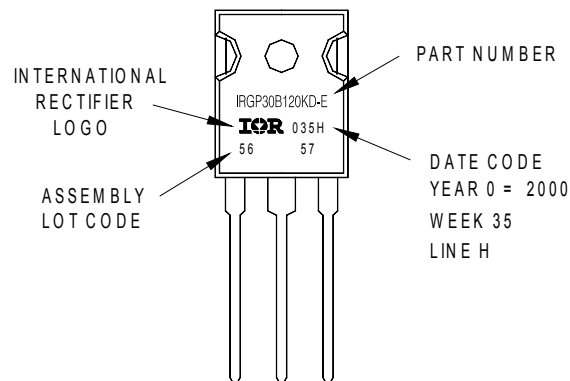
DIODES

- 1.- ANODE/OPEN
- 2.- CATHODE
- 3.- ANODE

## TO-247AD Part Marking Information

EXAMPLE: THIS IS AN IRGP30B120KD-E  
WITH ASSEMBLY  
LOT CODE 5657  
ASSEMBLED ON WW 35, 2000  
IN THE ASSEMBLY LINE "H"

Note: "P" in assembly line position  
indicates "Lead-Free"



TO-247AD package is not recommended for Surface Mount Application.

Note: For the most current drawing please refer to IR website at <http://www.irf.com/package/>

**Qualification Information<sup>†</sup>**

<b>Qualification Level</b>	Industrial (per JEDEC JESD47F) <sup>††</sup>	
<b>Moisture Sensitivity Level</b>	TO-247AC	N/A
	TO-247AD	
<b>RoHS Compliant</b>	Yes	

† Qualification standards can be found at International Rectifier's web site: <http://www.irf.com/product-info/reliability/>

†† Applicable version of JEDEC standard at the time of product release.

**Revision History**

<b>Date</b>	<b>Comments</b>
11/14/2014	<ul style="list-style-type: none"> <li>• Added I<sub>FM</sub> Diode Maximum Forward Current = 140A with the note ④ on page 1.</li> <li>• Removed note ④ from switching losses test condition on page 2.</li> </ul>