

# IRHMS9A97064 (JANSR2N7664T1)

PD-97988A

## Radiation Hardened Power MOSFET Thru-Hole (TO-254AA Low Ohmic) -60V, -45A, P-channel, R9 Superjunction Technology

### Features

- Single event effect (SEE) hardened (up to LET of 92.4 MeV·cm<sup>2</sup>/mg)
- Low R<sub>DS(on)</sub>
- Improved SOA for linear mode operation
- Fast switching
- Low total gate charge
- Simple drive requirements
- Hermetically sealed
- Electrically isolated
- Ceramic eyelets
- ESD rating: Class 3B per MIL-STD-750, Method 1020

### Potential Applications

- DC-DC converter
- Motor drives
- Power distribution
- Latching current limiter

### Product Validation

Qualified according to MIL-PRF-19500 for space applications

### Description

IR HiRel R9 technology provides superior power MOSFETs for space applications. This family of p-channel MOSFETs are the first radiation hardened devices that are based on a superjunction technology. These devices have improved immunity to Single Event Effect (SEE) and have been characterized for useful performance with Linear Energy Transfer (LET) up to 92.4 MeV·cm<sup>2</sup>/mg. Their combination of low R<sub>DS(on)</sub> and improved SOA allows for better performance in applications such as Latching Current Limiters (LCL), Solid-State Power Controllers (SSPC) or DC-DC converters. These devices retain all of the well-established advantages of MOSFETs such as voltage control, fast switching and temperature stability of electrical parameters.

### Ordering Information

**Table 1** Ordering options

Part number	Package	Screening Level	TID Level
IRHMS9A97064	Low-Ohmic TO-254AA	COTS	100 krad (Si)
JANSR2N7664T1	Low-Ohmic TO-254AA	JANS	100 krad (Si)
IRHMS9A93064	Low-Ohmic TO-254AA	COTS	300 krad (Si)
JANSF2N7664T1	Low-Ohmic TO-254AA	JANS	300 krad (Si)

### Product Summary

- **BV<sub>DSS</sub>**: -60V
- **I<sub>D</sub>**: -45A\*
- **R<sub>DS(on), max</sub>**: 12.5mΩ
- **Q<sub>G, max</sub>**: 221nC
- **REF**: MIL-PRF-19500/791



**Table of contents**

**Table of contents**

<b>Features .....</b>	<b>1</b>
<b>Potential Applications.....</b>	<b>1</b>
<b>Product Validation.....</b>	<b>1</b>
<b>Description .....</b>	<b>1</b>
<b>Ordering Information.....</b>	<b>1</b>
<b>Table of contents.....</b>	<b>2</b>
<b>1 Absolute Maximum Ratings .....</b>	<b>3</b>
<b>2 Device Characteristics .....</b>	<b>4</b>
2.1 Electrical Characteristics (Pre-Irradiation).....	4
2.2 Source-Drain Diode Ratings and Characteristics (Pre-Irradiation) .....	5
2.3 Thermal Characteristics .....	5
2.4 Radiation Characteristics.....	5
2.4.1 Electrical Characteristics — Post Total Dose Irradiation .....	5
2.4.2 Single Event Effects — Safe Operating Area .....	6
<b>3 Electrical Characteristics Curves (Pre-irradiation) .....</b>	<b>7</b>
<b>4 Test Circuits (Pre-irradiation) .....</b>	<b>11</b>
<b>5 Package Outline.....</b>	<b>12</b>
<b>Revision history.....</b>	<b>13</b>

## Absolute Maximum Ratings

## 1 Absolute Maximum Ratings

Table 2 Absolute Maximum Ratings (Pre-Irradiation)

Symbol	Parameter	Value	Unit
$I_{D1} @ V_{GS} = -12V, T_C = 25^\circ C$	Continuous Drain Current	-45*	A
$I_{D2} @ V_{GS} = -12V, T_C = 100^\circ C$	Continuous Drain Current	-45*	A
$I_{DM} @ T_C = 25^\circ C$	Pulsed Drain Current <sup>1</sup>	-180	A
$P_D @ T_C = 25^\circ C$	Maximum Power Dissipation	208	W
	Linear Derating Factor	1.7	W/°C
$V_{GS}$	Gate-to-Source Voltage	± 20	V
$E_{AS}$	Single Pulse Avalanche Energy <sup>2</sup>	9922	mJ
$I_{AR}$	Avalanche Current <sup>1</sup>	-45	A
$E_{AR}$	Repetitive Avalanche Energy <sup>1</sup>	20.8	mJ
dv/dt	Peak Diode Reverse Recovery <sup>3</sup>	6.7	V/ns
$T_J$ $T_{STG}$	Operating Junction and Storage Temperature Range	-55 to +150	°C
	Lead Temperature	300 (0.063 in. /1.6 mm from case for 10s)	
	Weight	9.3 (Typical)	g

\*Current is limited by package

<sup>1</sup> Repetitive Rating; Pulse width limited by maximum junction temperature.<sup>2</sup>  $V_{DD} = -60V$ , starting  $T_J = 25^\circ C$ ,  $L = 9.8mH$ , Peak  $I_L = -45A$ ,  $V_{GS} = -20V$ <sup>3</sup>  $I_{SD} \leq -45A$ ,  $di/dt \leq -800A/\mu s$ ,  $V_{DD} \leq -60V$ ,  $T_J \leq 150^\circ C$

## Device Characteristics

## 2 Device Characteristics

## 2.1 Electrical Characteristics (Pre-Irradiation)

Table 3 Static and Dynamic Electrical Characteristics @  $T_j = 25^\circ\text{C}$  (Unless Otherwise Specified)

Symbol	Parameter	Min.	Typ.	Max.	Unit	Test Conditions
$BV_{DSS}$	Drain-to-Source Breakdown Voltage	-60	—	—	V	$V_{GS} = 0V, I_D = -1.0mA$
$\Delta BV_{DSS}/\Delta T_J$	Breakdown Voltage Temp. Coefficient	—	-0.07	—	V/ $^\circ\text{C}$	Reference to $25^\circ\text{C}$ , $I_D = -1.0mA$
$R_{DS(on)}$	Static Drain-to-Source On-State Resistance	—	—	12.5	m $\Omega$	$V_{GS} = -12V, I_{D2} = -45A^1$
$V_{GS(th)}$	Gate Threshold Voltage	-2.0	—	-4.0	V	$V_{DS} \geq V_{GS}, I_D = -5mA$
$\Delta V_{GS(th)}/\Delta T_J$	Gate Threshold Voltage Coefficient	—	5.9	—	mV/ $^\circ\text{C}$	
Gfs	Forward Transconductance	50	—	—	S	$V_{DS} = -15V, I_{D2} = -45A^1$
$I_{DSS}$	Zero Gate Voltage Drain Current	—	—	-10	$\mu\text{A}$	$V_{DS} = -48V, V_{GS} = 0V$
		—	—	-25		$V_{DS} = -48V, V_{GS} = 0V, T_J = 125^\circ\text{C}$
$I_{GSS}$	Gate-to-Source Leakage Forward	—	—	-100	nA	$V_{GS} = -20V$
	Gate-to-Source Leakage Reverse	—	—	100		$V_{GS} = 20V$
$Q_G$	Total Gate Charge	—	—	221	nC	$I_{D1} = -45A$
$Q_{GS}$	Gate-to-Source Charge	—	—	53		$V_{DS} = -30V$
$Q_{GD}$	Gate-to-Drain ('Miller') Charge	—	—	54		$V_{GS} = -12V$
$t_{d(on)}$	Turn-On Delay Time	—	—	33	ns	$I_{D1} = -45A^{**}$
$t_r$	Rise Time	—	—	116		$V_{DD} = -30V$
$t_{d(off)}$	Turn-Off Delay Time	—	—	264		$R_G = 2.4\Omega$
$t_f$	Fall Time	—	—	159		$V_{GS} = -12V$
$L_s + L_D$	Total Inductance	—	6.8	—	nH	Measured from Drain lead (6mm / 0.25in from package) to Source lead (6mm / 0.25in from package) with Source wire internally bonded from Source pin to Drain pad
$C_{iss}$	Input Capacitance	—	10240	—	pF	$V_{GS} = 0V$
$C_{oss}$	Output Capacitance	—	3415	—		$V_{DS} = -25V$
$C_{rss}$	Reverse Transfer Capacitance	—	23	—		$f = 100KHz$
$R_G$	Gate Resistance	—	3.4	—	$\Omega$	$f = 1.0MHz$ , open drain

\*\* Switching speed maximum limits are based on manufacturing test equipment and capability.

<sup>1</sup> Pulse width  $\leq 300 \mu\text{s}$ ; Duty Cycle  $\leq 2\%$

## Device Characteristics

## 2.2 Source-Drain Diode Ratings and Characteristics (Pre-Irradiation)

Table 4 Source-Drain Diode Characteristics

Symbol	Parameter	Min.	Typ.	Max.	Unit	Test Conditions
$I_S$	Continuous Source Current (Body Diode)	—	—	-45	A	
$I_{SM}$	Pulsed Source Current (Body Diode) <sup>1</sup>	—	—	-180	A	
$V_{SD}$	Diode Forward Voltage	—	—	-1.3	V	$T_J = 25^\circ\text{C}$ , $I_S = -45\text{A}$ , $V_{GS} = 0\text{V}$ <sup>2</sup>
$t_{rr}$	Reverse Recovery Time	—	100	125	ns	$T_J = 25^\circ\text{C}$ , $I_F = -45\text{A}$ , $V_{DD} \leq -25\text{V}$ $di/dt = -100\text{A}/\mu\text{s}$
$Q_{rr}$	Reverse Recovery Charge	—	355	—	nC	
$t_{on}$	Forward Turn-On Time	Intrinsic turn-on time is negligible (turn-on is dominated by $L_S+L_D$ )				

## 2.3 Thermal Characteristics

Table 5 Thermal Resistance

Symbol	Parameter	Min.	Typ.	Max.	Unit
$R_{\theta JC}$	Junction-to-Case	—	—	0.6	$^\circ\text{C}/\text{W}$
$R_{\theta CS}$	Junction-to-Sink	—	0.21	—	
$R_{\theta JA}$	Junction-to-Ambient (Typical socket mount)	—	—	48	

## 2.4 Radiation Characteristics

IR HiRel radiation hardened MOSFETs are tested to verify their radiation hardness capability. The hardness assurance program at IR HiRel is comprised of two radiation environments. Every manufacturing lot is tested for total ionizing dose (per notes 3 and 4) using the TO-3 package. Both pre- and post-irradiation performance are tested and specified using the same drive circuitry and test conditions in order to provide a direct comparison.

## 2.4.1 Electrical Characteristics — Post Total Dose Irradiation

Table 6 Electrical Characteristics @  $T_J = 25^\circ\text{C}$ , Post Total Dose Irradiation<sup>3,4</sup>

Symbol	Parameter	Up to 300 krad (Si) <sup>5</sup>		Unit	Test Conditions
		Min.	Max.		
$BV_{DSS}$	Drain-to-Source Breakdown Voltage	-60	—	V	$V_{GS} = 0\text{V}$ , $I_D = -1.0\text{mA}$
$V_{GS(th)}$	Gate Threshold Voltage	-2.0	-4.0	V	$V_{DS} \geq V_{GS}$ , $I_D = -5.0\text{mA}$
$I_{GSS}$	Gate-to-Source Leakage Forward	—	-100	nA	$V_{GS} = -20\text{V}$
	Gate-to-Source Leakage Reverse	—	100		$V_{GS} = 20\text{V}$
$I_{DSS}$	Zero Gate Voltage Drain Current	—	-10	$\mu\text{A}$	$V_{DS} = -48\text{V}$ , $V_{GS} = 0\text{V}$
$R_{DS(on)}$	Static Drain-to-Source On-State Resistance (TO-3) <sup>2</sup>	—	11.5	m $\Omega$	$V_{GS} = -12\text{V}$ , $I_{D2} = -45\text{A}$
$R_{DS(on)}$	Static Drain-to-Source On-State Resistance (Low-Ohmic TO-254AA) <sup>2</sup>	—	12.5	m $\Omega$	$V_{GS} = -12\text{V}$ , $I_{D2} = -45\text{A}$
$V_{SD}$	Diode Forward Voltage	—	-1.3	V	$V_{GS} = 0\text{V}$ , $I_F = -45\text{A}$

<sup>1</sup> Repetitive Rating; Pulse width limited by maximum junction temperature.

<sup>2</sup> Pulse width  $\leq 300 \mu\text{s}$ ; Duty Cycle  $\leq 2\%$

<sup>3</sup> Total Dose Irradiation with  $V_{GS}$  Bias.  $V_{GS} = -12\text{V}$  applied and  $V_{DS} = 0$  during irradiation per MIL-STD-750, Method 1019, condition A.

<sup>4</sup> Total Dose Irradiation with  $V_{DS}$  Bias.  $V_{DS} = -48\text{V}$  applied and  $V_{GS} = 0$  during irradiation per MIL-STD-750, Method 1019, condition A.

<sup>5</sup> Part numbers IRHMS9A97064 (JANSR2N7664T1) and IRHMS9A93064 (JANSF2N7664T1)

Device Characteristics

2.4.2 Single Event Effects — Safe Operating Area

IR HiRel radiation hardened MOSFETs have been characterized in heavy ion environment for Single Event Effects (SEE). Single Event Effects characterization is illustrated in Fig. 1 and Table 7.

Table 7 Typical Single Event Effects Safe Operating Area

LET (MeV·cm <sup>2</sup> /mg)	Energy (MeV)	Range (μm)	V <sub>DS</sub> (V)			
			V <sub>GS</sub> = 0V	V <sub>GS</sub> = 1V	V <sub>GS</sub> = 5V	V <sub>GS</sub> = 10V
39.7 ± 5%	365 ± 7.5%	43.2 ± 7.5%	-60	-60	-60	-60
68 ± 5%	665 ± 7.5%	51.9 ± 7.5%	-60	-60	-60	-60
92.4 ± 5%	1202 ± 7.5%	69.6 ± 7.5%	-60	-60	—	—

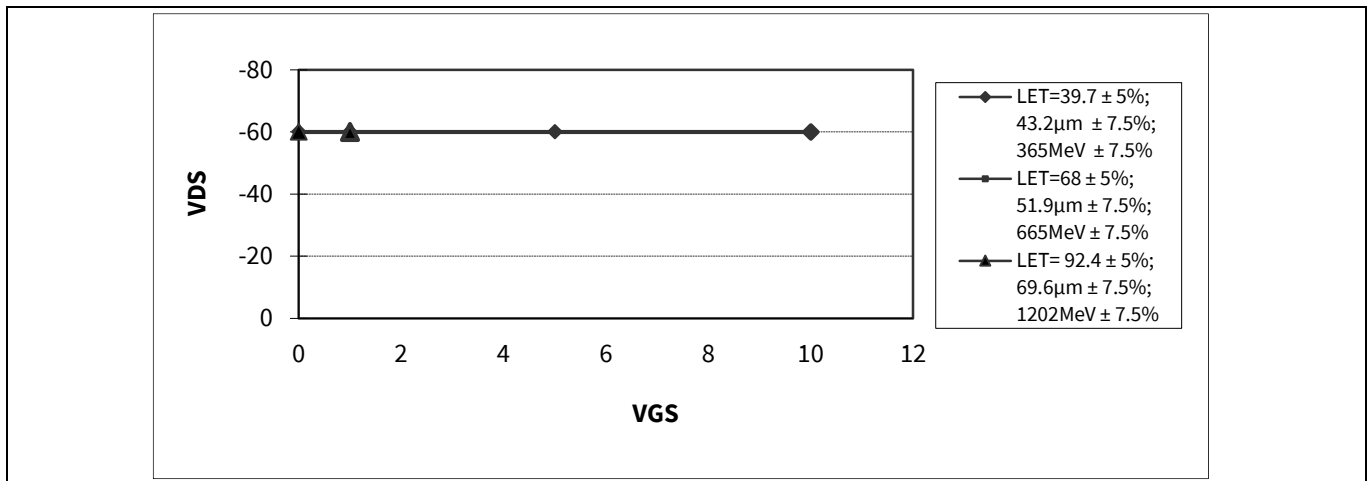


Figure 1 Typical Single Event Effect, Safe Operating Area

Electrical Characteristics Curves (Pre-irradiation)

### 3 Electrical Characteristics Curves (Pre-irradiation)

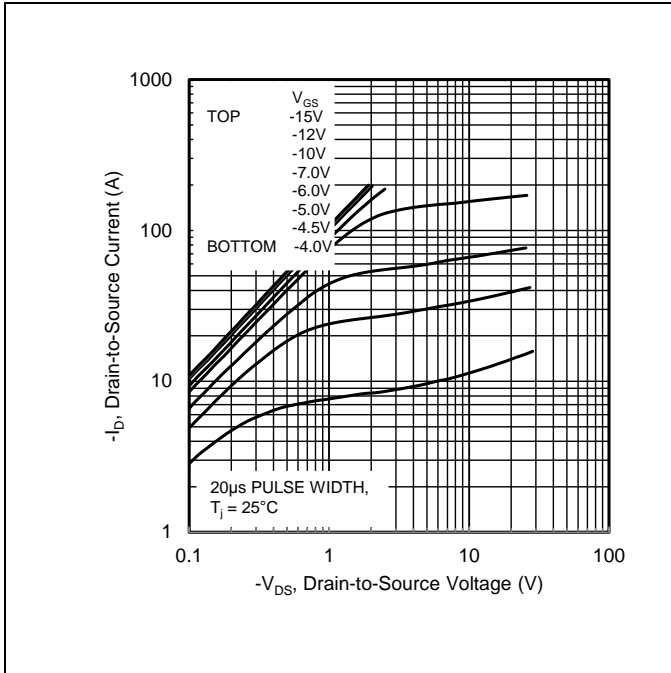


Figure 2 Typical Output Characteristics

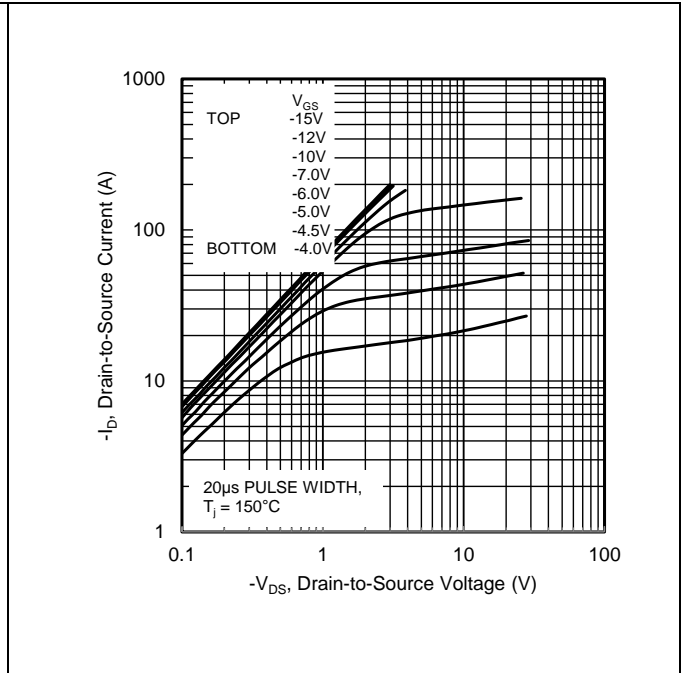


Figure 3 Typical Output Characteristics

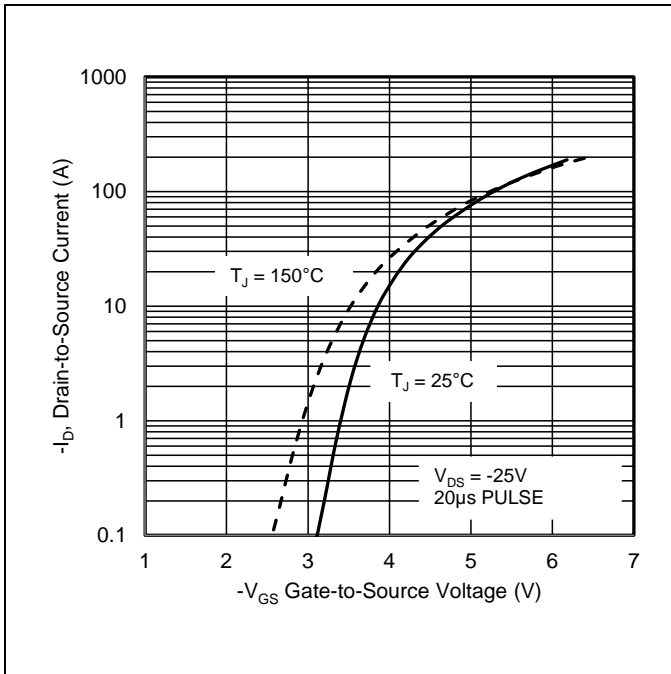


Figure 4 Typical Transfer Characteristics

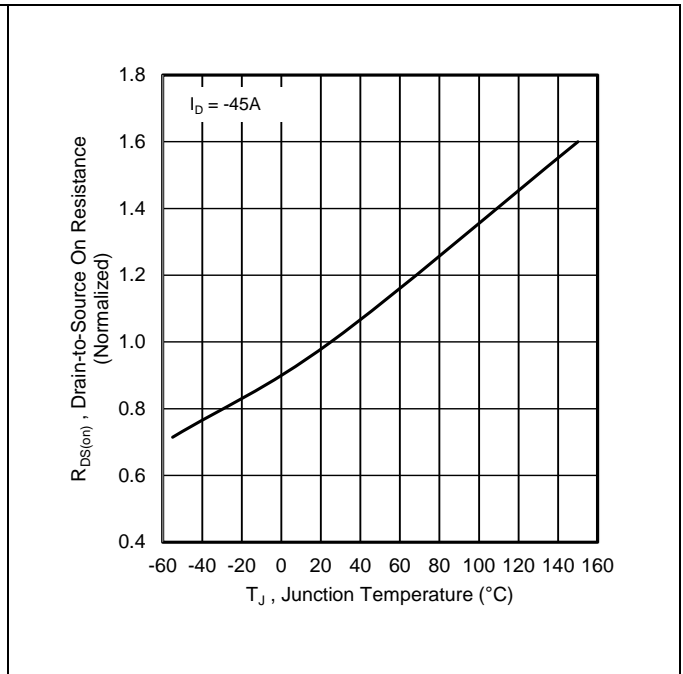
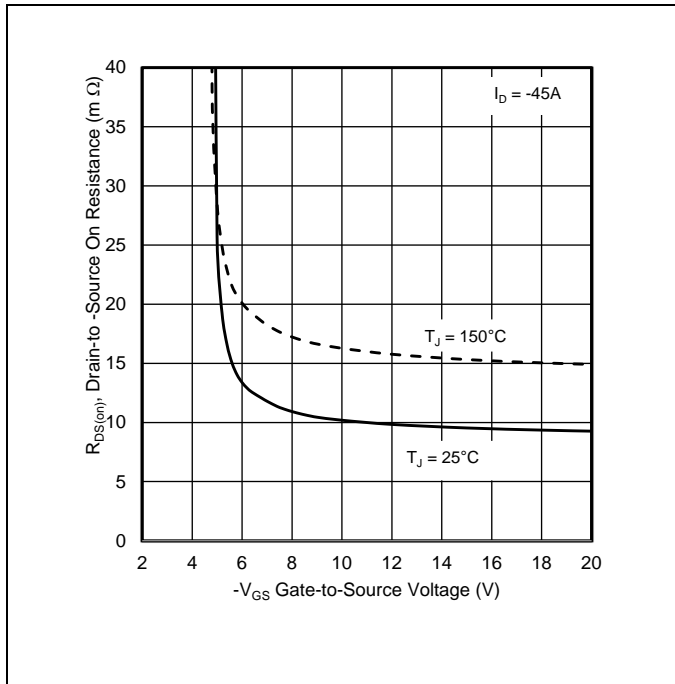


Figure 5 Normalized On-Resistance Vs. Temperature

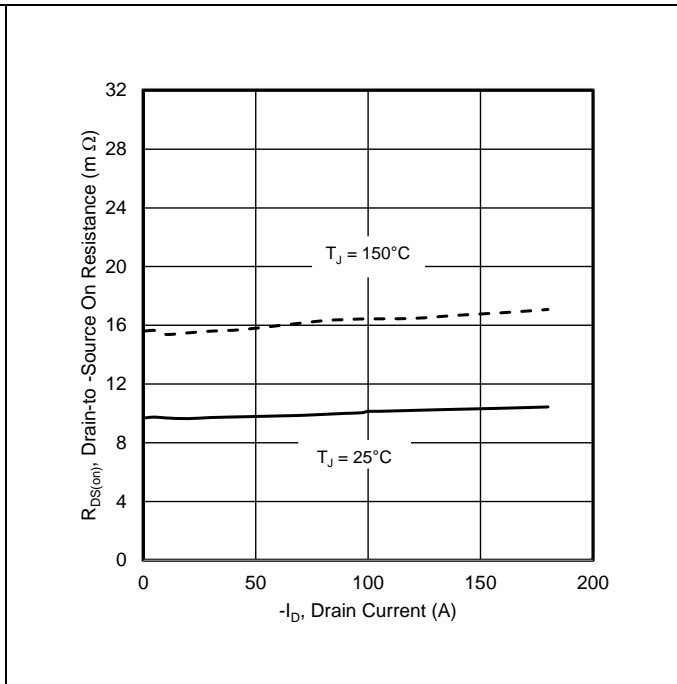
**IRHMS9A97064 (JANSR2N7664T1)**

**Radiation Hardened Power MOSFET Thru-Hole (TO-254AA Low Ohmic)**

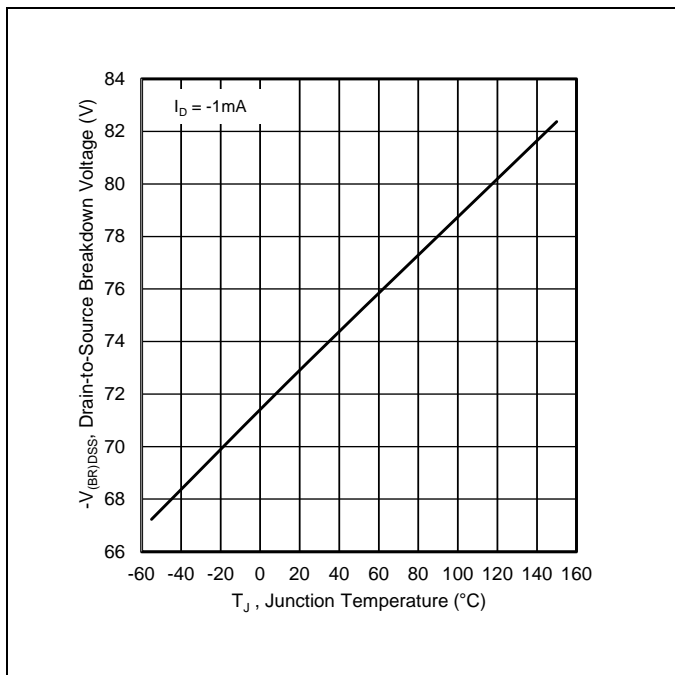
**Electrical Characteristics Curves (Pre-irradiation)**



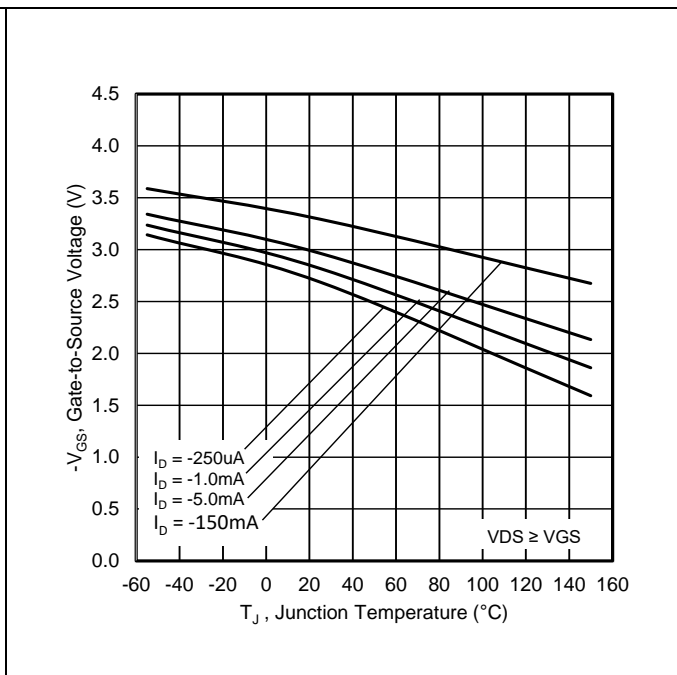
**Figure 6 Typical On-Resistance Vs Gate Voltage**



**Figure 7 Typical On-Resistance Vs Drain Current**



**Figure 8 Typical Drain-to-Source Breakdown Voltage Vs. Temperature**



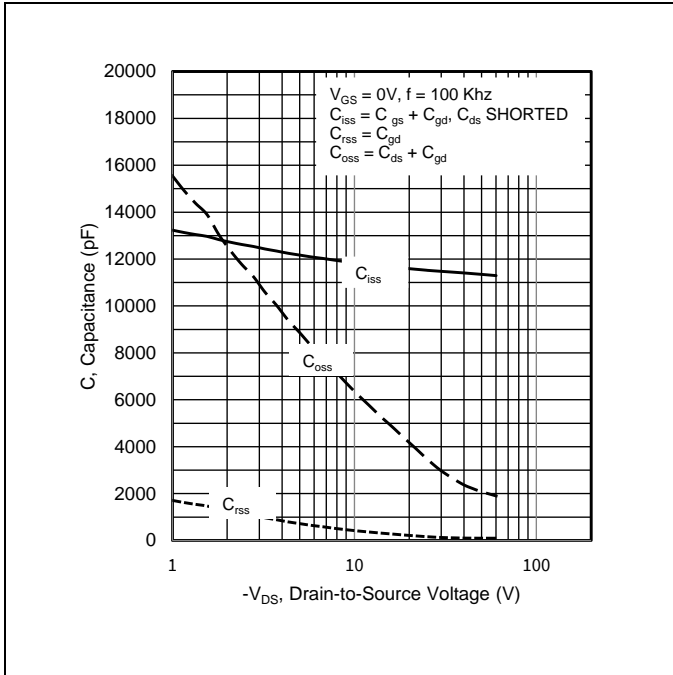
**Figure 9 Typical Gate-to-Source Voltage Vs. Temperature**



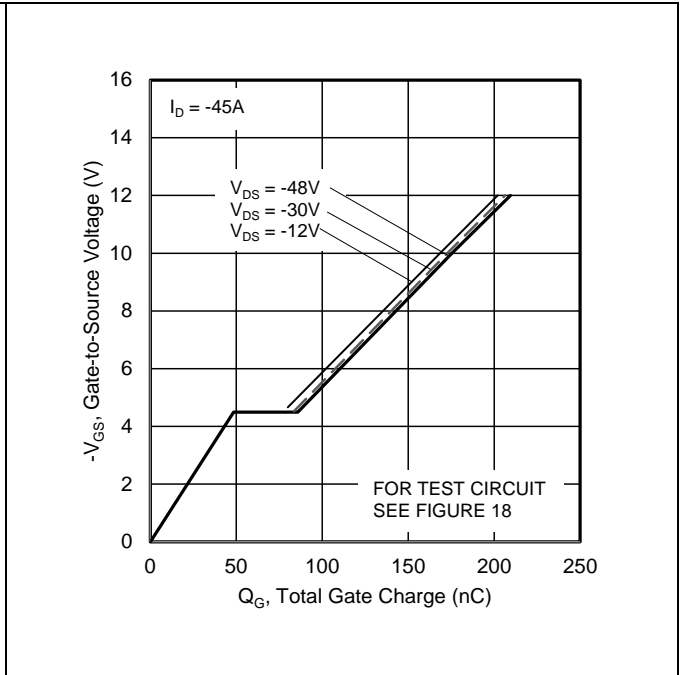
**IRHMS9A97064 (JANSR2N7664T1)**

**Radiation Hardened Power MOSFET Thru-Hole (TO-254AA Low Ohmic)**

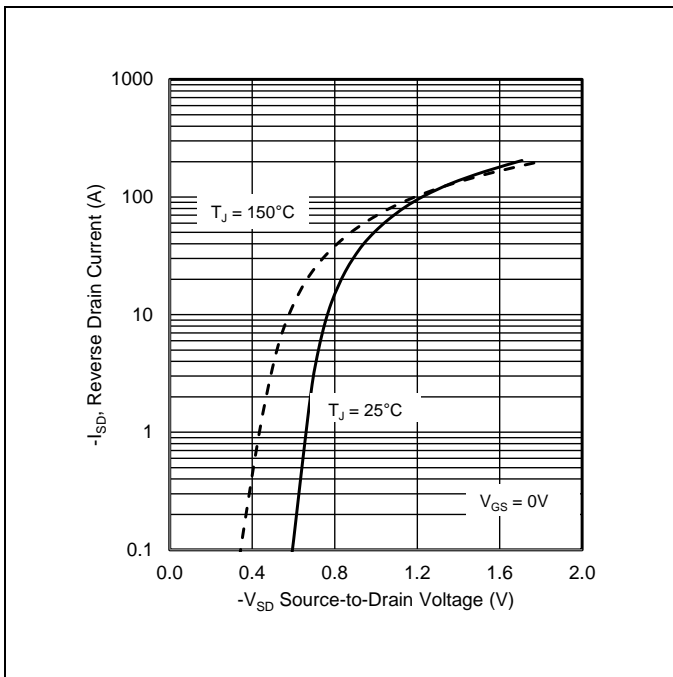
**Electrical Characteristics Curves (Pre-irradiation)**



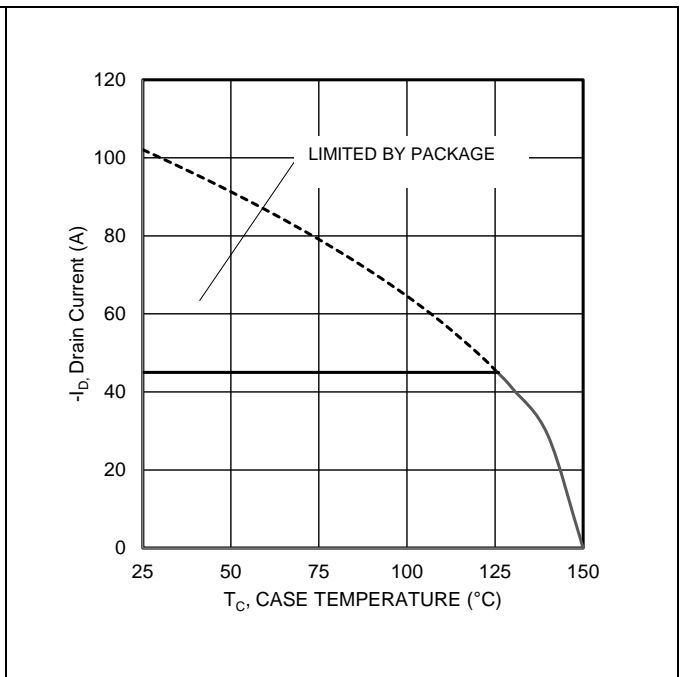
**Figure 10 Typical Capacitance Vs. Drain-to-Source Voltage**



**Figure 11 Gate-to-Source Voltage Vs. Typical Gate Charge**



**Figure 12 Typical Source-Drain Current Vs. Diode Forward Voltage**

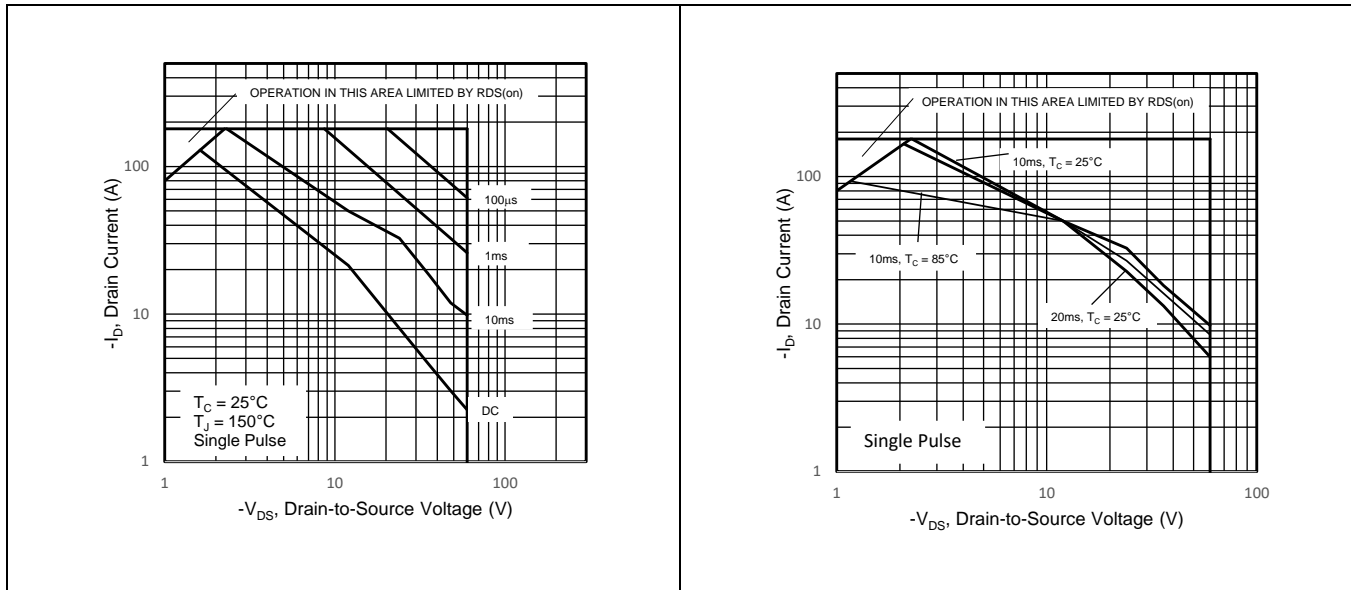


**Figure 13 Maximum Drain Current Vs. Temperature**

**IRHMS9A97064 (JANSR2N7664T1)**

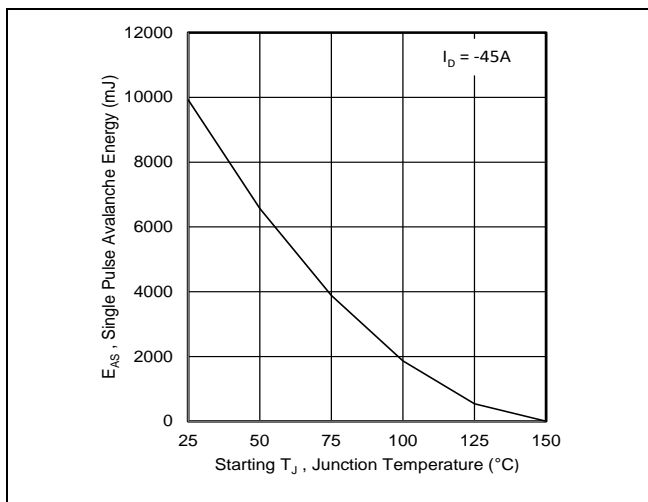
**Radiation Hardened Power MOSFET Thru-Hole (TO-254AA Low Ohmic)**

**Electrical Characteristics Curves (Pre-irradiation)**

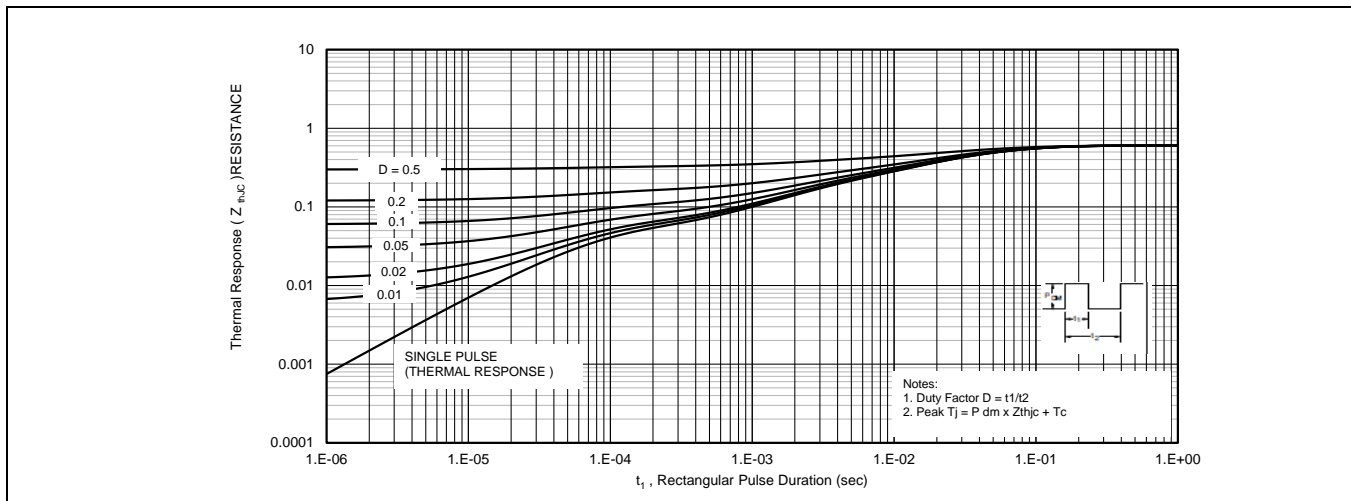


**Figure 14 Maximum Safe Operating Area**

**Figure 15 Maximum Safe Operating Area**



**Figure 16 Maximum Avalanche Energy Vs. Junction Temperature**



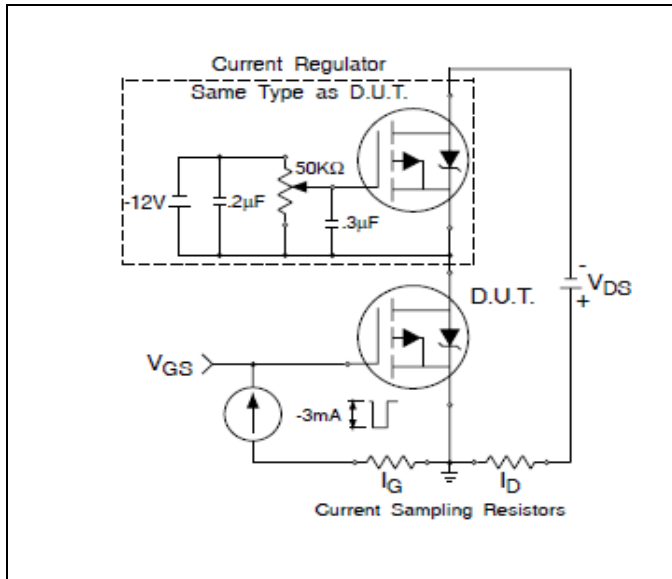
**Figure 17 Maximum Effective Transient Thermal Impedance, Junction-to-Case**

**IRHMS9A97064 (JANSR2N7664T1)**

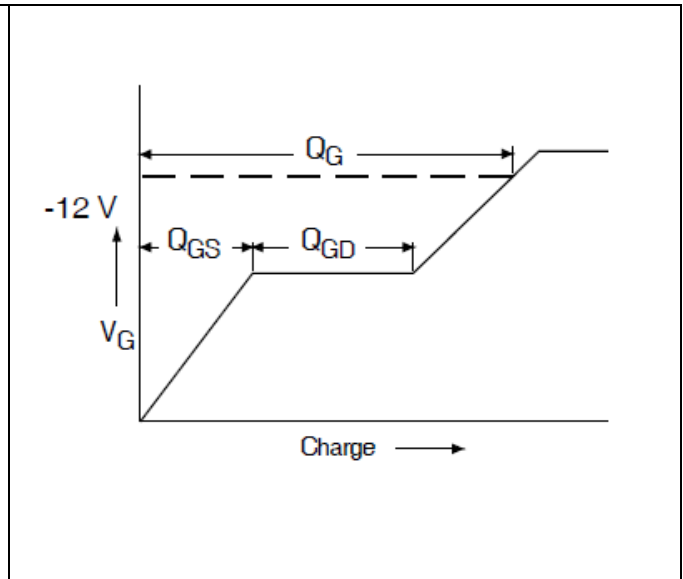
**Radiation Hardened Power MOSFET Thru-Hole (TO-254AA Low Ohmic)**

**Test Circuits (Pre-irradiation)**

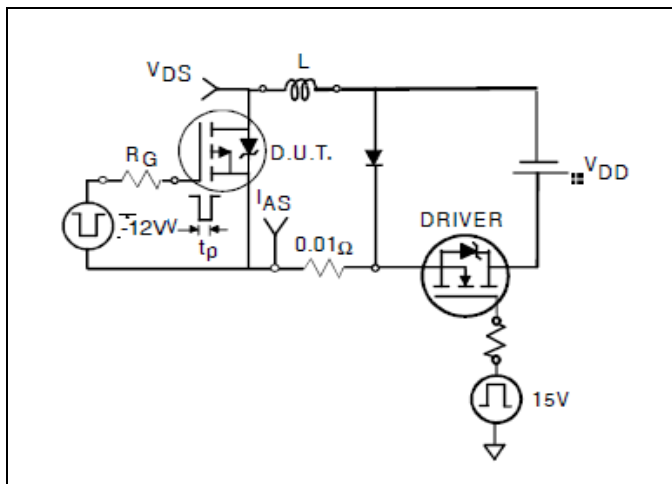
**4 Test Circuits (Pre-irradiation)**



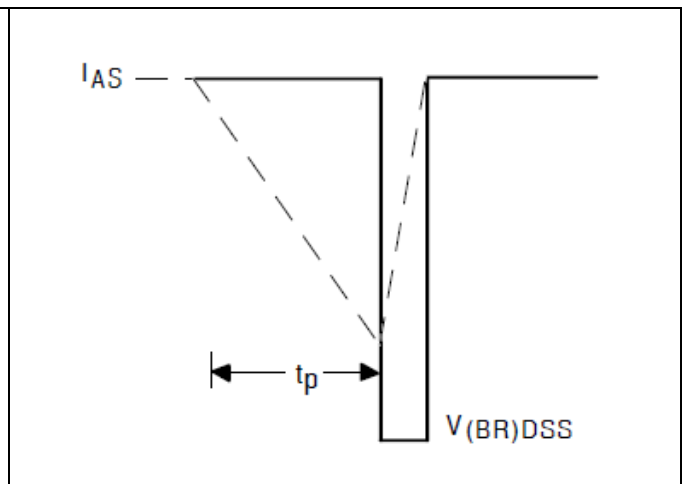
**Figure 18 Gate Charge Test Circuit**



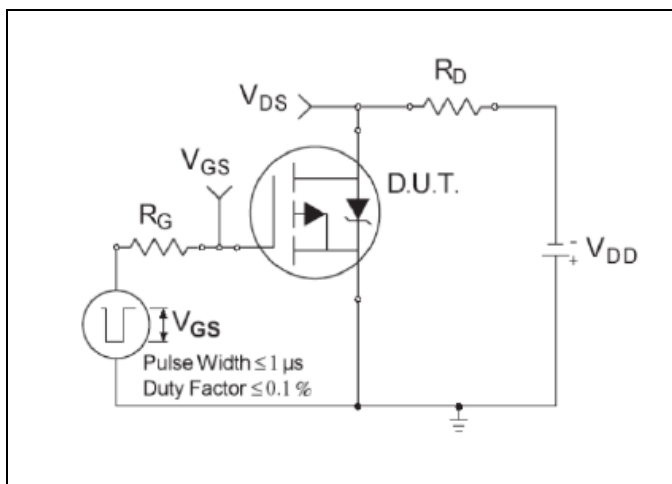
**Figure 19 Gate Charge Waveform**



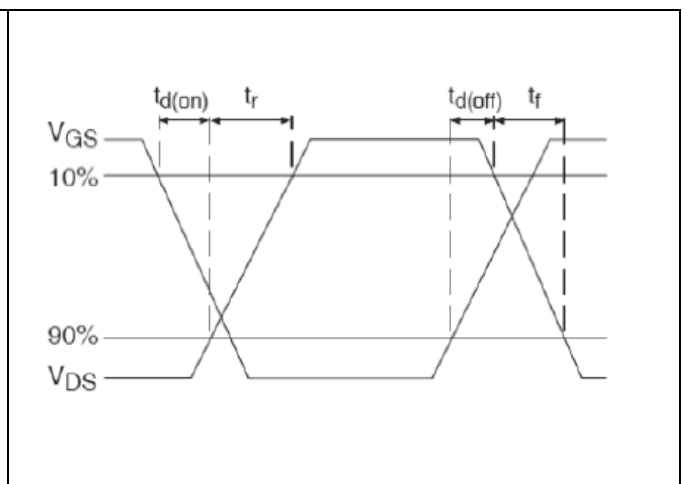
**Figure 20 Unclamped Inductive Test Circuit**



**Figure 21 Unclamped Inductive Waveform**



**Figure 22 Switching Time Test Circuit**

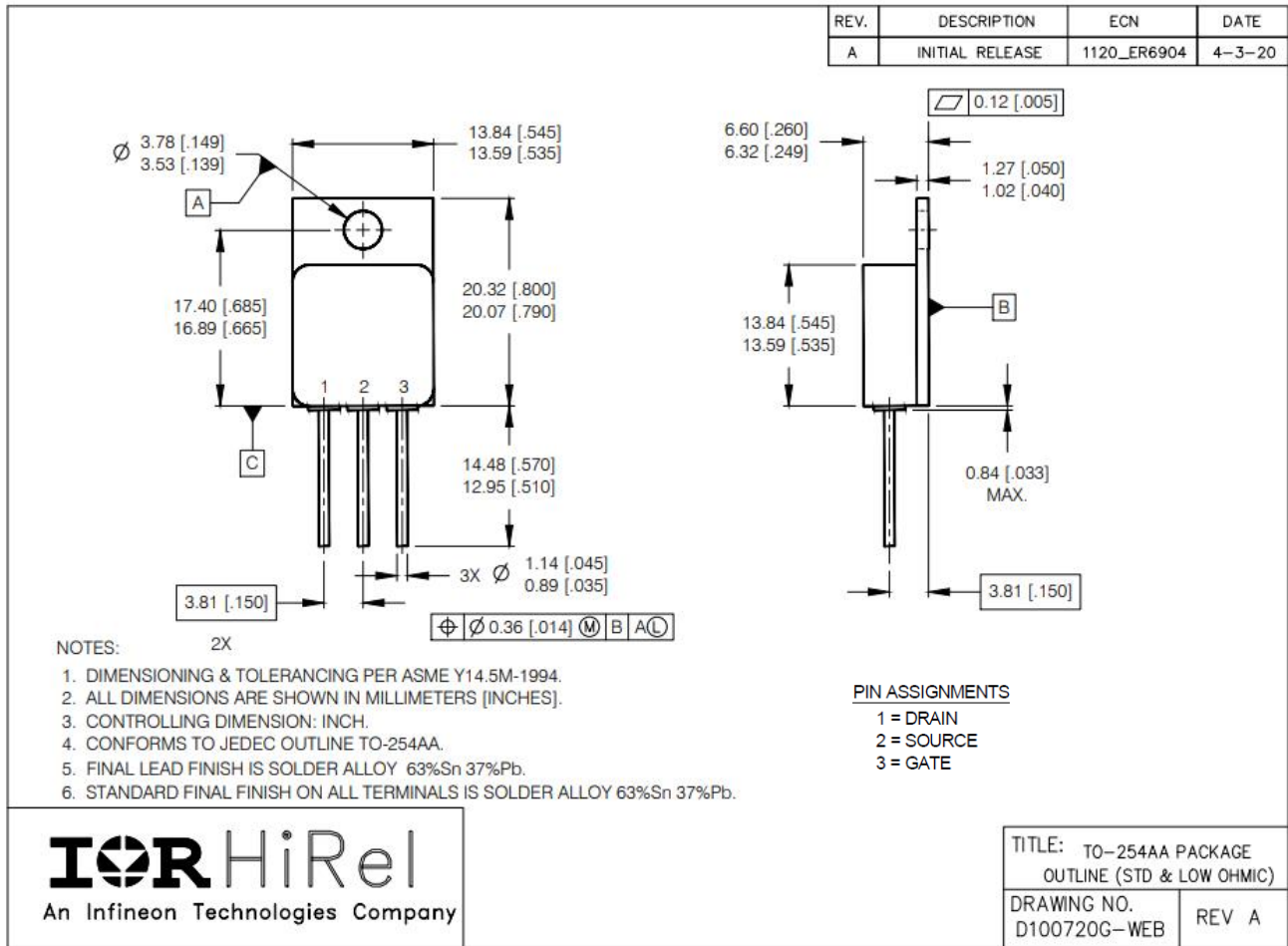


**Figure 23 Switching Time Waveforms**

Package Outline

# 5 Package Outline

Note: For the most updated package outline, please see the website: [Low-Ohmic TO-254AA](#)



**BERYLLIA WARNING PER MIL-PRF-19500**

Package containing beryllia shall not be ground, sandblasted, machined, or have other operations performed on them which will produce beryllia or beryllium dust. Furthermore, beryllium oxide packages shall not be placed in acids that will produce fumes containing beryllium.

# IRHMS9A97064 (JANSR2N7664T1)

## Radiation Hardened Power MOSFET Thru-Hole (TO-254AA Low Ohmic)

### Revision history

### Revision history

Document version	Date of release	Description of changes
	10/13/2023	Preliminary datasheet with PPD number (PPD-97983)
Rev A	11/20/2023	Final datasheet with PD number

## Trademarks

All referenced product or service names and trademarks are the property of their respective owners.

**Edition 2023-11-20**

**Published by**

**International Rectifier HiRel Products,  
Inc.**

**An Infineon Technologies company**

**El Segundo, California 90245 USA**

**© 2023 Infineon Technologies AG.**

**All Rights Reserved.**

**Do you have a question about this  
document?**

**Email: [erratum@infineon.com](mailto:erratum@infineon.com)**

**Document reference**

## IMPORTANT NOTICE

The information given in this document shall in no event be regarded as a guarantee of conditions or characteristics ("Beschaffheitsgarantie").

With respect to any examples, hints or any typical values stated herein and/or any information regarding the application of the product, Infineon Technologies hereby disclaims any and all warranties and liabilities of any kind, including without limitation warranties of non-infringement of intellectual property rights of any third party.

In addition, any information given in this document is subject to customer's compliance with its obligations stated in this document and any applicable legal requirements, norms and standards concerning customer's products and any use of the product of Infineon Technologies in customer's applications.

The data contained in this document is exclusively intended for technically trained staff. It is the responsibility of customer's technical departments to evaluate the suitability of the product for the intended application and the completeness of the product information given in this document with respect to such application.

For further information on the product, technology, delivery terms and conditions and prices please contact your nearest Infineon Technologies office ([www.infineon.com](http://www.infineon.com)).

## WARNINGS

Due to technical requirements components may contain dangerous substances. For information on the types in question please contact your nearest International Rectifier HiRel Products, Inc., an Infineon Technologies company, office.

International Rectifier HiRel Components may only be used in life-support devices or systems with the expressed written approval of International Rectifier HiRel Products, Inc., an Infineon Technologies company, if failure of such components can reasonably be expected to cause the failure of that life-support device or system, or to affect the safety and effectiveness of that device or system.

Life support devices or systems are intended to be implanted in the human body, or to support and/or maintain and sustain and/or protect human life. If they fail, it is reasonable to assume that the health of the user or other persons may be endangered.