

International IR Rectifier

- Logic-Level Gate Drive
- Advanced Process Technology
- Ultra Low On-Resistance
- Dynamic dv/dt Rating
- 175°C Operating Temperature
- Fast Switching
- Fully Avalanche Rated
- Lead-Free

Description

Fifth Generation HEXFET® power MOSFETs from International Rectifier utilize advanced processing techniques to achieve extremely low on-resistance per silicon area. This benefit, combined with the fast switching speed and ruggedized device design that HEXFET power MOSFETs are well known for, provides the designer with an extremely efficient and reliable device for use in a wide variety of applications.

The D²Pak is a surface mount power package capable of accommodating die sizes up to HEX-4. It provides the highest power capability and the lowest possible on-resistance in any existing surface mount package. The D²Pak is suitable for high current applications because of its low internal connection resistance and can dissipate up to 2.0W in a typical surface mount application.

The through-hole version (IRL1004L) is available for low-profile application.

Absolute Maximum Ratings

	Parameter	Max.	Units
$I_D @ T_C = 25^\circ\text{C}$	Continuous Drain Current, $V_{GS} @ 10V$ Ⓞ	130 Ⓞ	A
$I_D @ T_C = 100^\circ\text{C}$	Continuous Drain Current, $V_{GS} @ 10V$ Ⓞ	92 Ⓞ	
I_{DM}	Pulsed Drain Current ①Ⓞ	520	
$P_D @ T_A = 25^\circ\text{C}$	Power Dissipation	3.8	W
$P_D @ T_C = 25^\circ\text{C}$	Power Dissipation	200	W
	Linear Derating Factor	1.3	W/°C
V_{GS}	Gate-to-Source Voltage	± 16	V
E_{AS}	Single Pulse Avalanche EnergyⓄ	700	mJ
I_{AR}	Avalanche Current①	78	A
E_{AR}	Repetitive Avalanche Energy①	20	mJ
dv/dt	Peak Diode Recovery dv/dt ③Ⓞ	5.0	V/ns
T_J	Operating Junction and	-55 to + 175	°C
T_{STG}	Storage Temperature Range		
	Soldering Temperature, for 10 seconds	300 (1.6mm from case)	

Thermal Resistance

	Parameter	Typ.	Max.	Units
$R_{\theta JC}$	Junction-to-Case	—	0.75	°C/W
$R_{\theta JA}$	Junction-to-Ambient (PCB Mounted, steady-state)*	—	40	

www.irf.com

1

PD - 95575

IRL1004SPbF

IRL1004LPbF

HEXFET® Power MOSFET

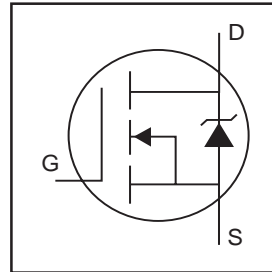

$$V_{DSS} = 40V$$

$$R_{DS(on)} = 0.0065\Omega$$

$$I_D = 130A \text{Ⓞ}$$

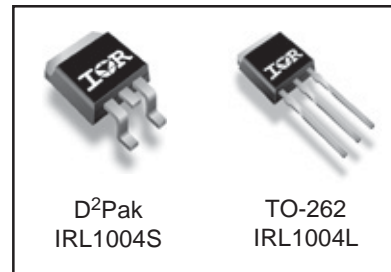

D²Pak
IRL1004S

TO-262
IRL1004L

Electrical Characteristics @ T_J = 25°C (unless otherwise specified)

	Parameter	Min.	Typ.	Max.	Units	Conditions
V _{(BR)DSS}	Drain-to-Source Breakdown Voltage	40	—	—	V	V _{GS} = 0V, I _D = 250μA
ΔV _{(BR)DSS} /ΔT _J	Breakdown Voltage Temp. Coefficient	—	0.04	—	V/°C	Reference to 25°C, I _D = 1mA
R _{DS(on)}	Static Drain-to-Source On-Resistance	—	—	0.0065	Ω	V _{GS} = 10V, I _D = 78A ④
		—	—	0.009		V _{GS} = 4.5V, I _D = 65A ④
V _{GS(th)}	Gate Threshold Voltage	1.0	—	—	V	V _{DS} = V _{GS} , I _D = 250μA
g _{fs}	Forward Transconductance	63	—	—	S	V _{DS} = 25V, I _D = 78A⑥
I _{DSS}	Drain-to-Source Leakage Current	—	—	25	μA	V _{DS} = 40V, V _{GS} = 0V
		—	—	250		V _{DS} = 32V, V _{GS} = 0V, T _J = 150°C
I _{GSS}	Gate-to-Source Forward Leakage	—	—	100	nA	V _{GS} = 16V
	Gate-to-Source Reverse Leakage	—	—	-100		V _{GS} = -16V
Q _g	Total Gate Charge	—	—	100	nC	I _D = 78A
Q _{gs}	Gate-to-Source Charge	—	—	32		V _{DS} = 32V
Q _{gd}	Gate-to-Drain ("Miller") Charge	—	—	43		V _{GS} = 4.5V, See Fig. 6 and 13 ④⑥
t _{d(on)}	Turn-On Delay Time	—	16	—	ns	V _{DD} = 20V,
t _r	Rise Time	—	210	—		I _D = 78A,
t _{d(off)}	Turn-Off Delay Time	—	25	—		R _G = 2.5Ω,
t _f	Fall Time	—	14	—		R _D = 0.18Ω, See Fig. 10 ④⑥
L _S	Internal Source Inductance	—	7.5	—	nH	Between lead, and center of die contact
C _{iss}	Input Capacitance	—	5330	—	pF	V _{GS} = 0V
C _{oss}	Output Capacitance	—	1480	—		V _{DS} = 25V
C _{rss}	Reverse Transfer Capacitance	—	320	—		f = 1.0MHz, See Fig. 5④⑥

Source-Drain Ratings and Characteristics

	Parameter	Min.	Typ.	Max.	Units	Conditions
I _S	Continuous Source Current (Body Diode)②	—	—	130⑤	A	MOSFET symbol showing the integral reverse p-n junction diode.
I _{SM}	Pulsed Source Current (Body Diode) ①②	—	—	520		
V _{SD}	Diode Forward Voltage	—	—	1.3	V	T _J = 25°C, I _S = 78A, V _{GS} = 0V④
t _{rr}	Reverse Recovery Time	—	78	120	ns	T _J = 25°C, I _F = 78A
Q _{rr}	Reverse Recovery Charge	—	180	270	nC	di/dt = 100A/μs④⑥
t _{on}	Forward Turn-On Time	Intrinsic turn-on time is negligible (turn-on is dominated by L _S +L _D)				

Notes:

- ① Repetitive rating; pulse width limited by max. junction temperature. (See fig. 11)
- ② Starting T_J = 25°C, L = 0.23mH
R_G = 25Ω, I_{AS} = 78A. (See Figure 12)
- ③ I_{SD} ≤ 78A, di/dt ≤ 370A/μs, V_{DD} ≤ V_{(BR)DSS},
T_J ≤ 175°C
- ④ Pulse width ≤ 300μs; duty cycle ≤ 2%.
- ⑤ Calculated continuous current based on maximum allowable junction temperature; for recommended current-handing of the package refer to Design Tip # 93-4
- ⑥ Uses IRL1004 data and test conditions

* When mounted on 1" square PCB (FR-4 or G-10 Material).
For recommended footprint and soldering techniques refer to application note #AN-994.

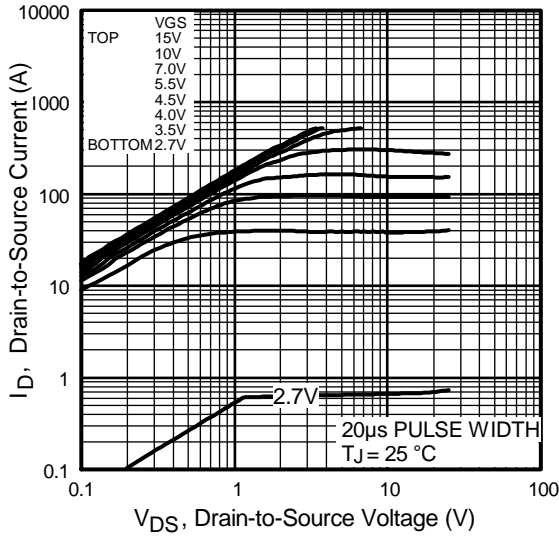

Fig 1. Typical Output Characteristics

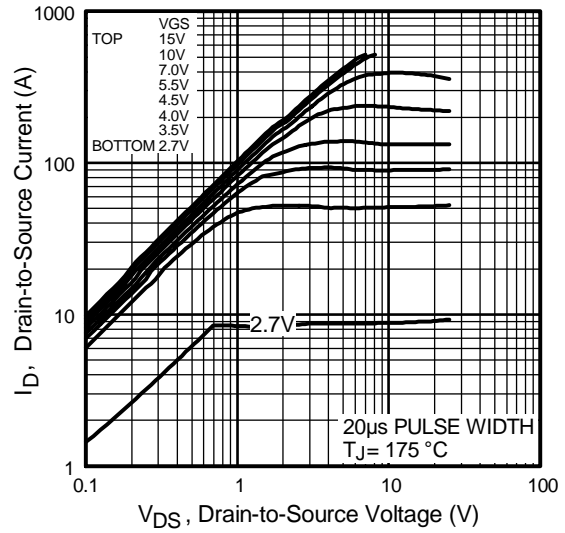

Fig 2. Typical Output Characteristics

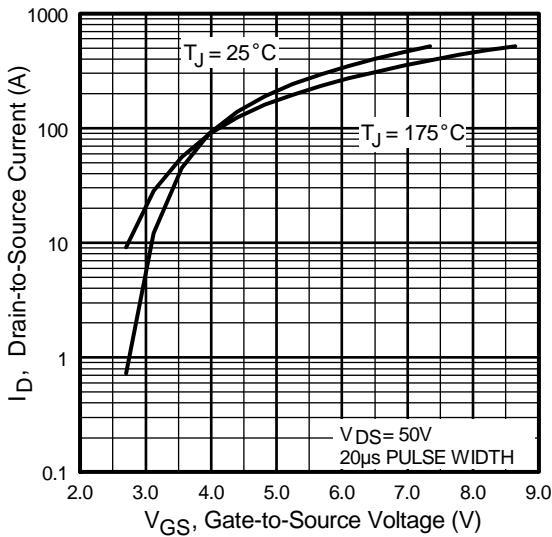

Fig 3. Typical Transfer Characteristics

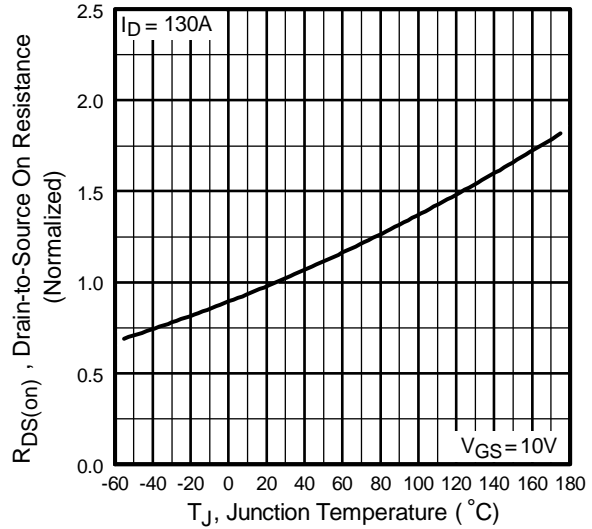

Fig 4. Normalized On-Resistance Vs. Temperature

IRL1004S/LPbF

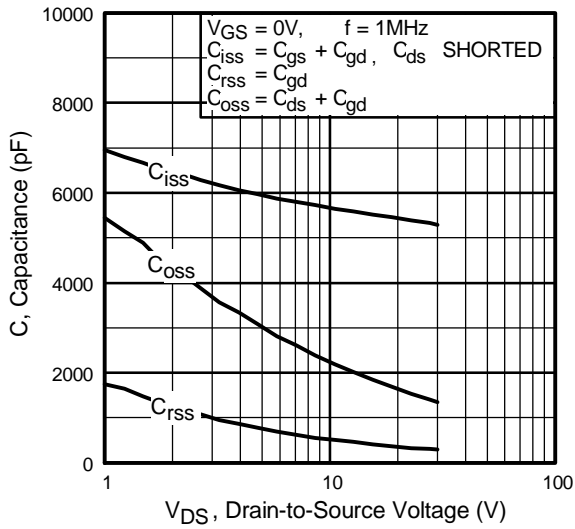

Fig 5. Typical Capacitance Vs. Drain-to-Source Voltage

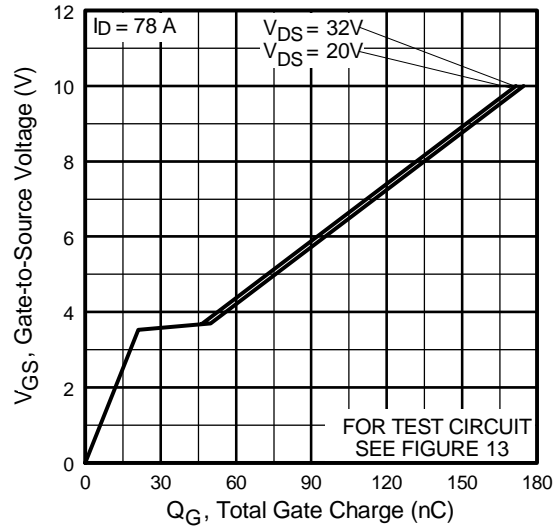

Fig 6. Typical Gate Charge Vs. Gate-to-Source Voltage

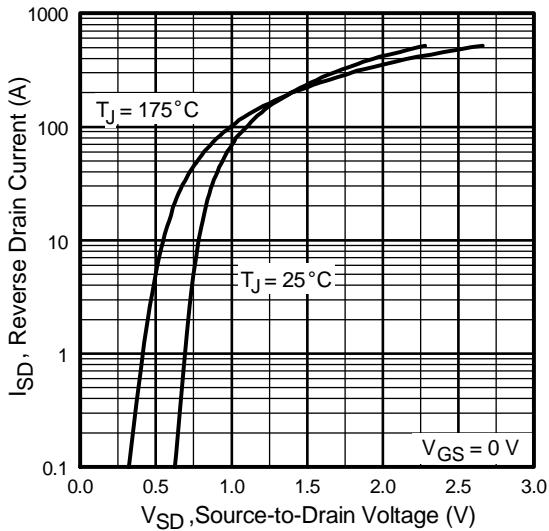

Fig 7. Typical Source-Drain Diode Forward Voltage

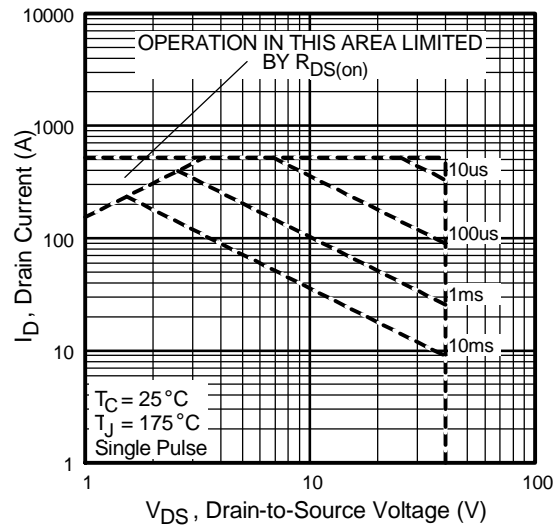

Fig 8. Maximum Safe Operating Area

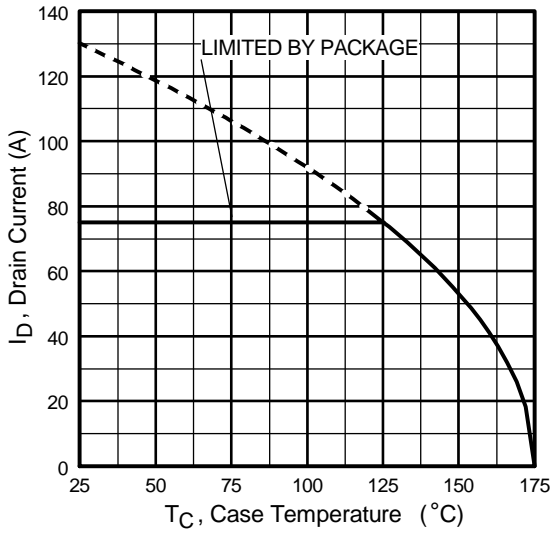

Fig 9. Maximum Drain Current Vs. Case Temperature

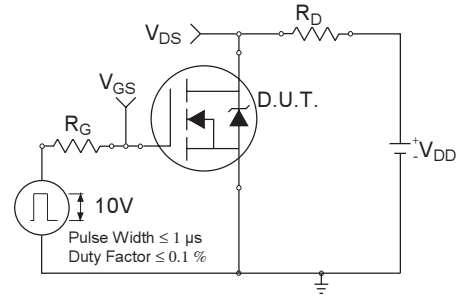

Fig 10a. Switching Time Test Circuit

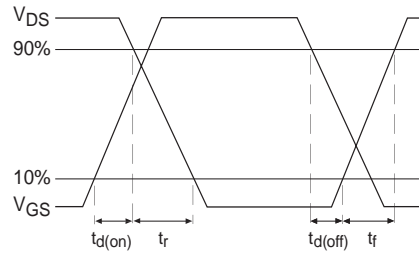

Fig 10b. Switching Time Waveforms

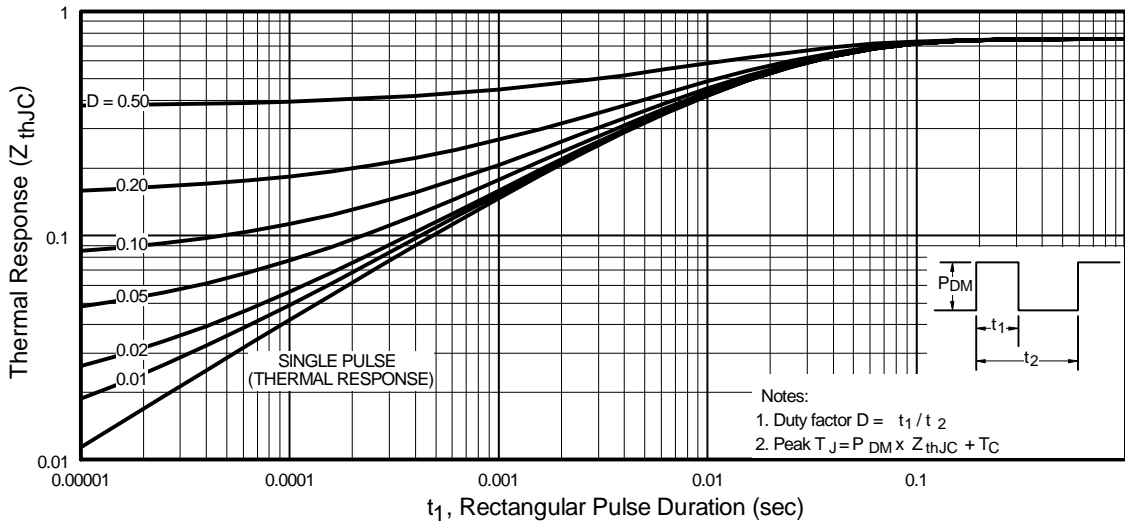

Fig 11. Maximum Effective Transient Thermal Impedance, Junction-to-Case

IRL1004S/LPbF

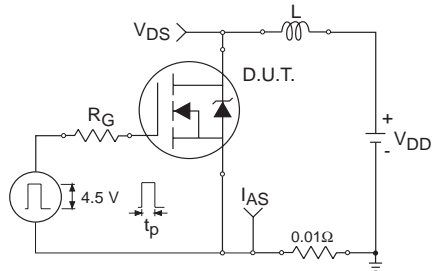

Fig 12a. Unclamped Inductive Test Circuit

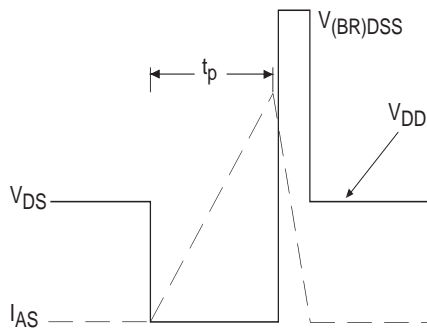

Fig 12b. Unclamped Inductive Waveforms

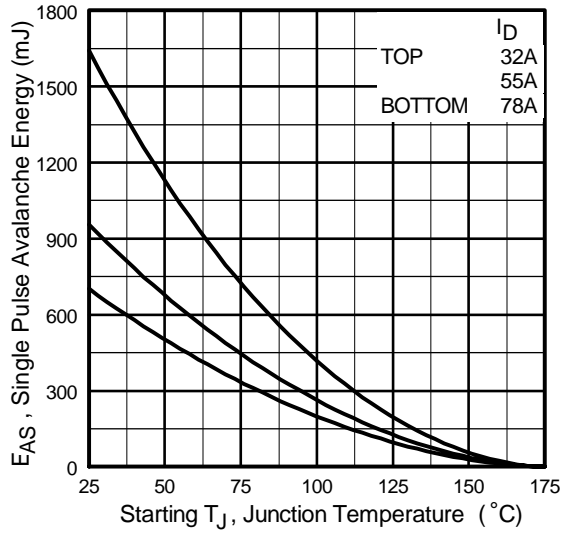

Fig 12c. Maximum Avalanche Energy Vs. Drain Current

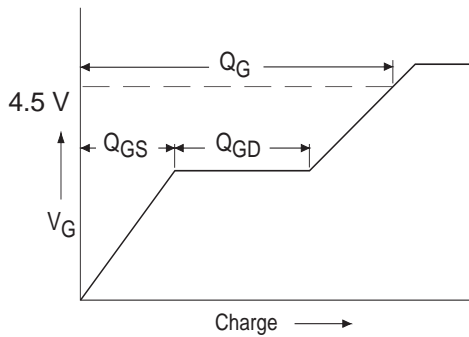

Fig 13a. Basic Gate Charge Waveform

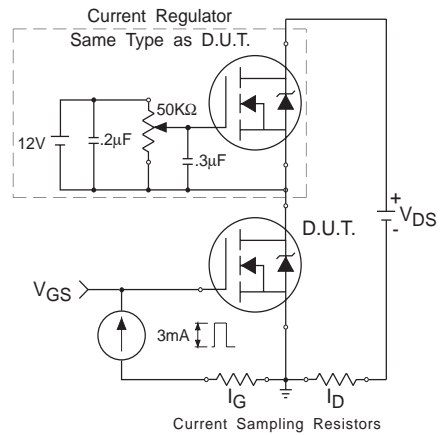
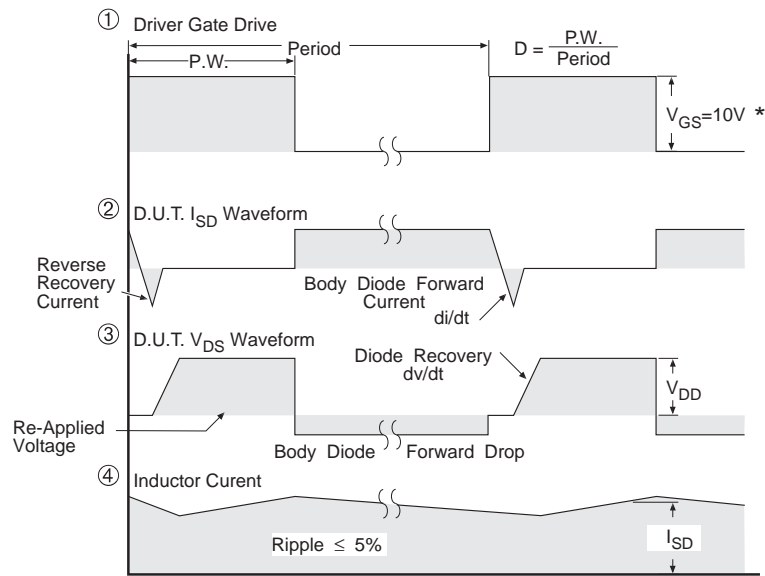
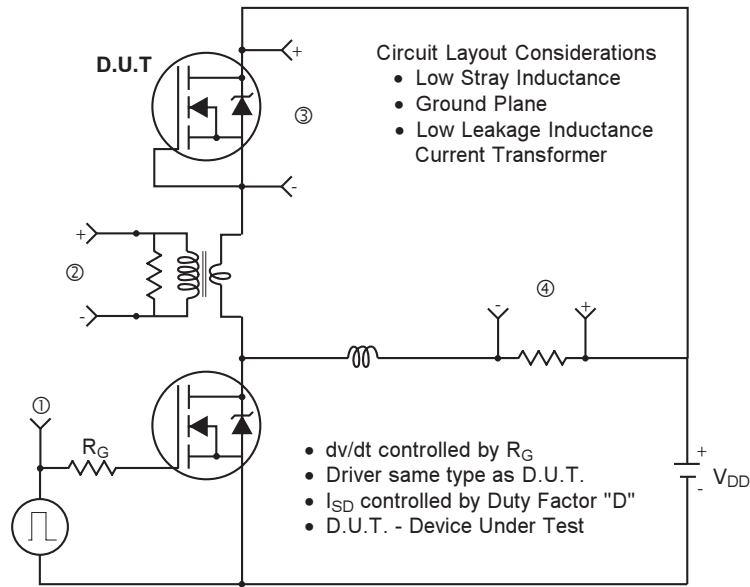

Fig 13b. Gate Charge Test Circuit

Peak Diode Recovery dv/dt Test Circuit



* $V_{GS} = 5V$ for Logic Level Devices

Fig 14. For N-channel HEXFET® Power MOSFETs

IRL1004S/LPbF

International
IR Rectifier

D²Pak Package Outline

Dimensions are shown in millimeters (inches)

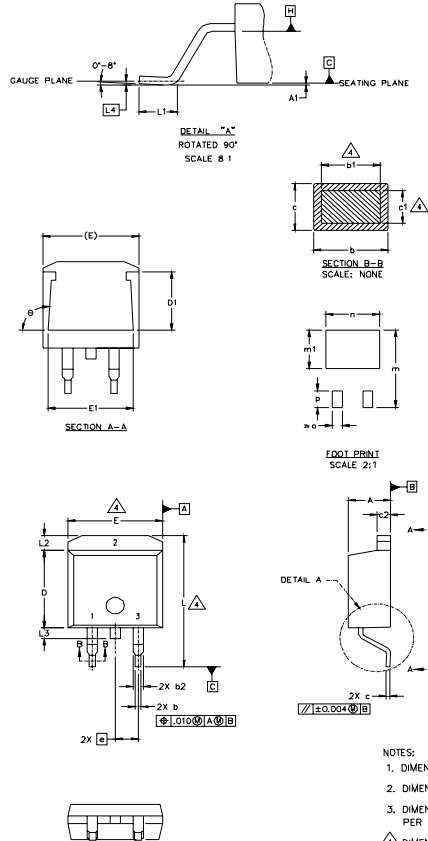

SYMBOL	DIMENSIONS				NOTES
	MILLIMETERS		INCHES		
	MIN.	MAX.	MIN.	MAX.	
A	4.06	4.83	.160	.190	4
A1		0.127	.005	.005	
b	0.51	0.99	.020	.039	
b1	0.51	0.89	.020	.035	4
b2	1.14	1.40	.045	.055	
c	0.43	0.63	.017	.025	
c1	0.38	0.74	.015	.029	3
c2	1.14	1.40	.045	.055	
D	8.51	9.65	.335	.380	
D1	5.33		.210		3
E	9.65	10.67	.380	.420	
E1	6.22		.245		
e	2.54	BSC	.100	BSC	
L	14.61	15.88	.575	.625	
L1	1.78	2.79	.070	.110	
L2		1.65		.065	
L3	1.27	1.78	.050	.070	
L4	0.25	BSC	.010	BSC	
m	17.78		.700		
m1	8.89		.350		
n	11.43		.450		
o	2.08		.082		
p	3.81		.150		
θ	90°	93°	90°	93°	

LEAD ASSIGNMENTS

HEXFET	IGBTs, CoPACK	DIODES
1 - GATE	1 - GATE	1 - ANODE *
2 - DRAIN	2 - COLLECTOR	2 - CATHODE
3 - SOURCE	3 - EMITTER	3 - ANODE

* PART DEPENDENT.

- NOTES:
- DIMENSIONING AND TOLERANCING PER ASME Y14.5M-1994
 - DIMENSIONS ARE SHOWN IN MILLIMETERS [INCHES]
 - DIMENSION D & E DO NOT INCLUDE MOLD FLASH. MOLD FLASH SHALL NOT EXCEED 0.127 [0.005] PER SIDE. THESE DIMENSIONS ARE MEASURED AT THE OUTMOST EXTREMES OF THE PLASTIC BODY.
 - DIMENSION b1 AND c1 APPLY TO BASE METAL ONLY.
 - CONTROLLING DIMENSION: INCH.

D²Pak Part Marking Information

EXAMPLE: THIS IS AN IRF530S WITH LOT CODE 8024 ASSEMBLED ON WW 02, 2000 IN THE ASSEMBLY LINE "L"

Note: "P" in assembly line position indicates "Lead-Free"

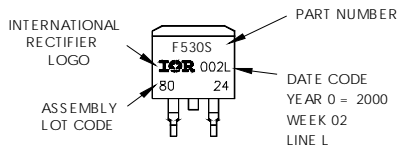

OR

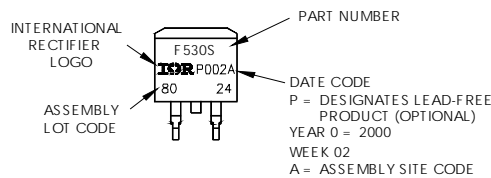

TO-262 Package Outline

Dimensions are shown in millimeters (inches)

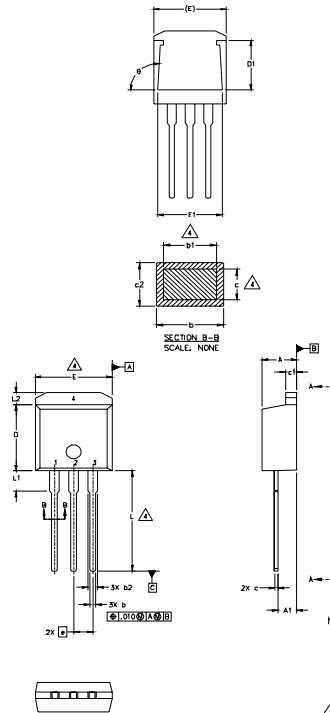

SYMBOL	DIMENSIONS				NOTES
	MILLIMETERS		INCHES		
	MIN.	MAX.	MIN.	MAX.	
A	4.06	4.83	.160	.190	4
A1	2.03	2.92	.080	.115	
b	0.51	0.99	.020	.039	
b1	0.51	0.89	.020	.035	
b2	1.14	1.40	.045	.055	4
c	0.38	0.63	.015	.025	
c1	1.14	1.40	.045	.055	3
c2	0.43	.063	.017	.029	
D	8.51	9.65	.335	.380	
D1	5.33		.210		3
E	9.65	10.67	.380	.420	
E1	6.22		.245		
e	2.54	BSC	.100	BSC	
L	13.46	14.09	.530	.555	
L1	3.56	3.71	.140	.146	
L2		1.65		.065	

LEAD ASSIGNMENTS

HEXFET	IGBT
1.- GATE	1 - GATE
2.- DRAIN	2 - COLLECTOR
3.- SOURCE	3 - EMITTER
4.- DRAIN	

- NOTES:
1. DIMENSIONING AND TOLERANCING PER ASME Y14.5M-1994
 2. DIMENSIONS ARE SHOWN IN MILLIMETERS [INCHES].
 3. DIMENSION D & E DO NOT INCLUDE MOLD FLASH. MOLD FLASH SHALL NOT EXCEED 0.127 [0.005"] PER SIDE. THESE DIMENSIONS ARE MEASURED AT THE OUTMOST EXTREMES OF THE PLASTIC BODY.
 4. DIMENSION b1 AND c1 APPLY TO BASE METAL ONLY.
 5. CONTROLLING DIMENSION: INCH.

TO-262 Part Marking Information

EXAMPLE: THIS IS AN IRL3103L
LOT CODE 1789
ASSEMBLED ON WW 19, 1997
IN THE ASSEMBLY LINE "C"
Note: "P" in assembly line
position indicates "Lead-Free"

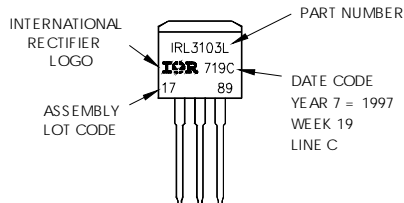

OR

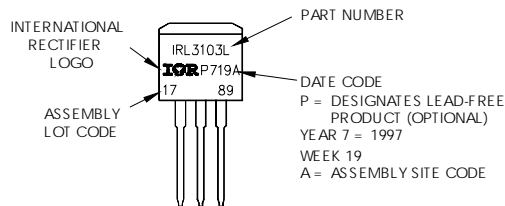

IRL1004S/LPbF

International
IR Rectifier

D²Pak Tape & Reel Information

Dimensions are shown in millimeters (inches)

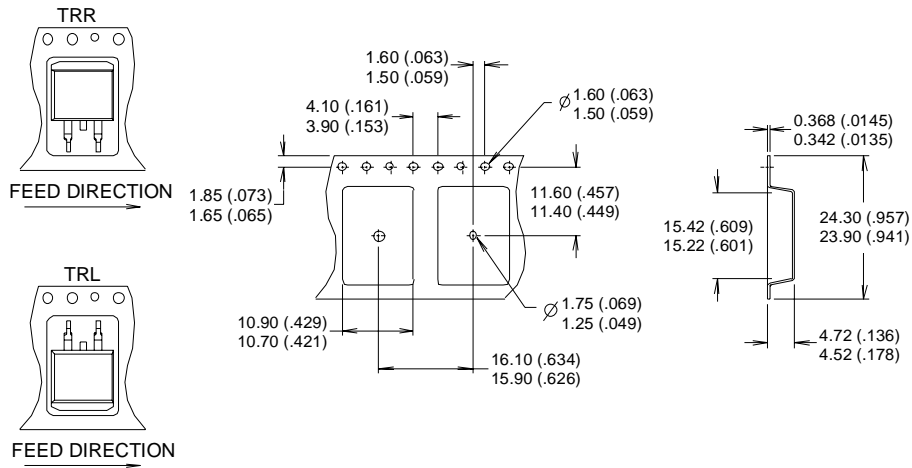

- NOTES :
1. CONFORMS TO EIA-418.
 2. CONTROLLING DIMENSION: MILLIMETER.
 3. DIMENSION MEASURED @ HUB.
 4. INCLUDES FLANGE DISTORTION @ OUTER EDGE.

Data and specifications subject to change without notice.

International
IR Rectifier

IR WORLD HEADQUARTERS: 233 Kansas St., El Segundo, California 90245, USA Tel: (310) 252-7105
TAC Fax: (310) 252-7903

Visit us at www.irf.com for sales contact information. 07/04