

## IRLZ34NPbF

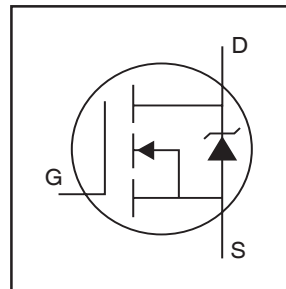
HEXFET® Power MOSFET

- Logic-Level Gate Drive
- Advanced Process Technology
- Dynamic dv/dt Rating
- 175°C Operating Temperature
- Fast Switching
- Fully Avalanche Rated
- Lead-Free

### Description

Fifth Generation HEXFETs from International Rectifier utilize advanced processing techniques to achieve the lowest possible on-resistance per silicon area. This benefit, combined with the fast switching speed and ruggedized device design that HEXFET Power MOSFETs are well known for, provides the designer with an extremely efficient device for use in a wide variety of applications.

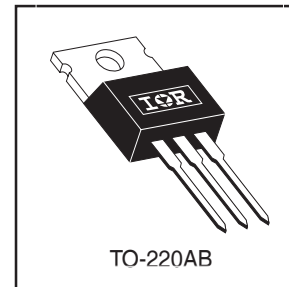
The TO-220 package is universally preferred for all commercial-industrial applications at power dissipation levels to approximately 50 watts. The low thermal resistance and low package cost of the TO-220 contribute to its wide acceptance throughout the industry.



$$V_{DSS} = 55V$$

$$R_{DS(on)} = 0.035\Omega$$

$$I_D = 30A$$



### Absolute Maximum Ratings

	Parameter	Max.	Units
$I_D @ T_C = 25^\circ C$	Continuous Drain Current, $V_{GS} @ 10V$	30	A
$I_D @ T_C = 100^\circ C$	Continuous Drain Current, $V_{GS} @ 10V$	21	
$I_{DM}$	Pulsed Drain Current $\text{\textcircled{D}}$	110	
$P_D @ T_C = 25^\circ C$	Power Dissipation	68	W
	Linear Derating Factor	0.45	W/°C
$V_{GS}$	Gate-to-Source Voltage	$\pm 16$	V
$E_{AS}$	Single Pulse Avalanche Energy $\text{\textcircled{2}}$	110	mJ
$I_{AR}$	Avalanche Current $\text{\textcircled{D}}$	16	A
$E_{AR}$	Repetitive Avalanche Energy $\text{\textcircled{D}}$	6.8	mJ
dv/dt	Peak Diode Recovery dv/dt $\text{\textcircled{3}}$	5.0	V/ns
$T_J$	Operating Junction and	-55 to + 175	°C
$T_{STG}$	Storage Temperature Range		
	Soldering Temperature, for 10 seconds	300 (1.6mm from case)	
	Mounting torque, 6-32 or M3 screw.	10 lbf•in (1.1N•m)	

### Thermal Resistance

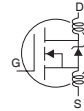
	Parameter	Min.	Typ.	Max.	Units
$R_{\theta JC}$	Junction-to-Case	---	---	2.2	°CW
$R_{\theta CS}$	Case-to-Sink, Flat, Greased Surface	---	0.50	---	
$R_{\theta JA}$	Junction-to-Ambient	---	---	62	

# IRLZ34NPbF

International  
**IR** Rectifier

## Electrical Characteristics @ $T_J = 25^\circ\text{C}$ (unless otherwise specified)

	Parameter	Min.	Typ.	Max.	Units	Conditions
$V_{(BR)DSS}$	Drain-to-Source Breakdown Voltage	55	—	—	V	$V_{GS} = 0V, I_D = 250\mu A$
$\Delta V_{(BR)DSS}/\Delta T_J$	Breakdown Voltage Temp. Coefficient	—	0.065	—	V/ $^\circ\text{C}$	Reference to $25^\circ\text{C}, I_D = 1\text{mA}$
$R_{DS(on)}$	Static Drain-to-Source On-Resistance	—	—	0.035	$\Omega$	$V_{GS} = 10V, I_D = 16A$ ④
		—	—	0.046		$V_{GS} = 5.0V, I_D = 16A$ ④
		—	—	0.060		$V_{GS} = 4.0V, I_D = 14A$ ④
$V_{GS(th)}$	Gate Threshold Voltage	1.0	—	2.0	V	$V_{DS} = V_{GS}, I_D = 250\mu A$
$g_{fs}$	Forward Transconductance	11	—	—	S	$V_{DS} = 25V, I_D = 16A$
$I_{DSS}$	Drain-to-Source Leakage Current	—	—	25	$\mu A$	$V_{DS} = 55V, V_{GS} = 0V$
		—	—	250		$V_{DS} = 44V, V_{GS} = 0V, T_J = 150^\circ\text{C}$
$I_{GSS}$	Gate-to-Source Forward Leakage	—	—	100	nA	$V_{GS} = 16V$
	Gate-to-Source Reverse Leakage	—	—	-100		$V_{GS} = -16V$
$Q_g$	Total Gate Charge	—	—	25	nC	$I_D = 16A$
$Q_{gs}$	Gate-to-Source Charge	—	—	5.2		$V_{DS} = 44V$
$Q_{gd}$	Gate-to-Drain ("Miller") Charge	—	—	14		$V_{GS} = 5.0V$ , See Fig. 6 and 13 ④
$t_{d(on)}$	Turn-On Delay Time	—	8.9	—		ns
$t_r$	Rise Time	—	100	—	$I_D = 16A$	
$t_{d(off)}$	Turn-Off Delay Time	—	21	—	$R_G = 6.5\Omega, V_{GS} = 5.0V$	
$t_f$	Fall Time	—	29	—	$R_D = 1.8\Omega$ , See Fig. 10 ④	
$L_D$	Internal Drain Inductance	—	4.5	—	nH	Between lead, 6mm (0.25in.) from package and center of die contact
$L_S$	Internal Source Inductance	—	7.5	—		
$C_{iss}$	Input Capacitance	—	880	—	pF	$V_{GS} = 0V$
$C_{oss}$	Output Capacitance	—	220	—		$V_{DS} = 25V$
$C_{rss}$	Reverse Transfer Capacitance	—	94	—		$f = 1.0\text{MHz}$ , See Fig. 5



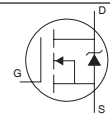
## Source-Drain Ratings and Characteristics

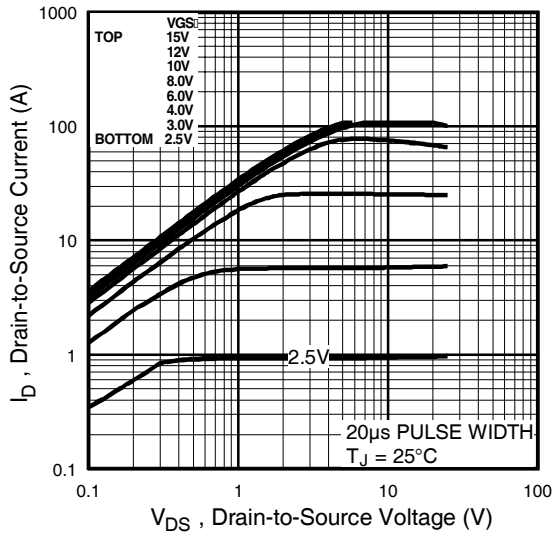
	Parameter	Min.	Typ.	Max.	Units	Conditions
$I_S$	Continuous Source Current (Body Diode)	—	—	30	A	MOSFET symbol showing the integral reverse p-n junction diode.
$I_{SM}$	Pulsed Source Current (Body Diode) ①	—	—	110		
$V_{SD}$	Diode Forward Voltage	—	—	1.3	V	$T_J = 25^\circ\text{C}, I_S = 16A, V_{GS} = 0V$ ②
$t_{rr}$	Reverse Recovery Time	—	76	110	ns	$T_J = 25^\circ\text{C}, I_F = 16A$
$Q_{rr}$	Reverse Recovery Charge	—	190	290	nC	$di/dt = 100A/\mu s$ ③
$t_{on}$	Forward Turn-On Time	Intrinsic turn-on time is negligible (turn-on is dominated by $L_S+L_D$ )				

### Notes:

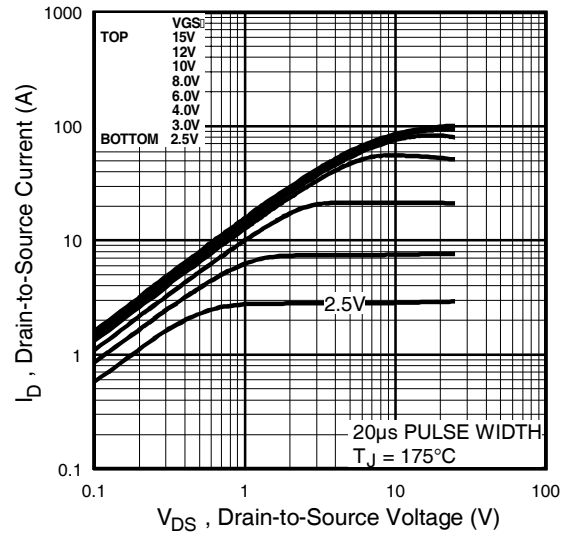
- ① Repetitive rating; pulse width limited by max. junction temperature. ( See fig. 11 )  
 ②  $V_{DD} = 25V$ , starting  $T_J = 25^\circ\text{C}$ ,  $L = 610\mu H$   
 $R_G = 25\Omega, I_{AS} = 16A$ . (See Figure 12)

- ③  $I_{SD} \leq 16A, di/dt \leq 270A/\mu s, V_{DD} \leq V_{(BR)DSS}$ .  
 $T_J \leq 175^\circ\text{C}$   
 ④ Pulse width  $\leq 300\mu s$ ; duty cycle  $\leq 2\%$ .

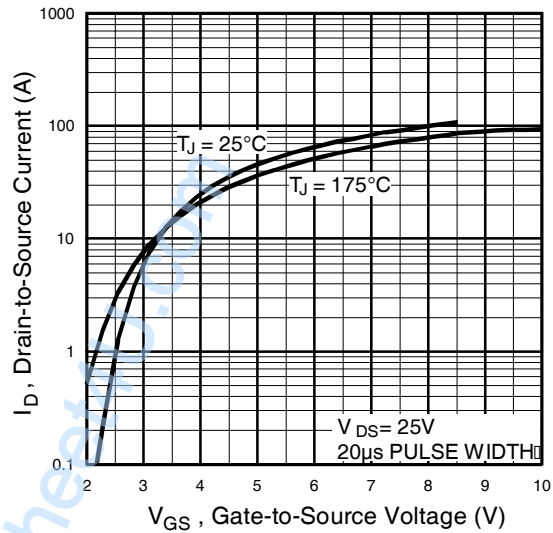




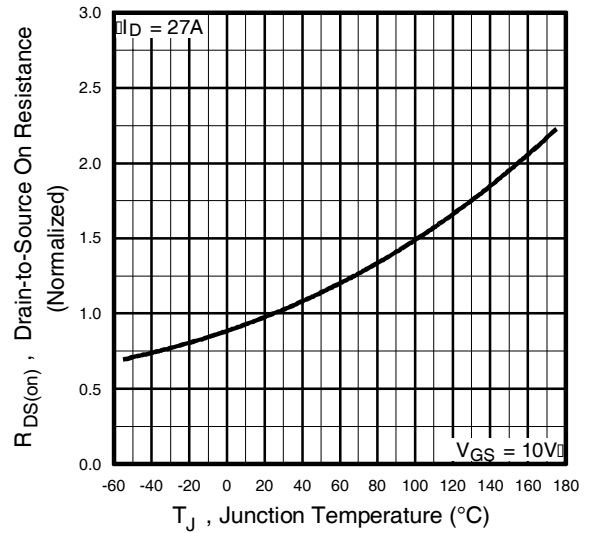
**Fig 1.** Typical Output Characteristics



**Fig 2.** Typical Output Characteristics

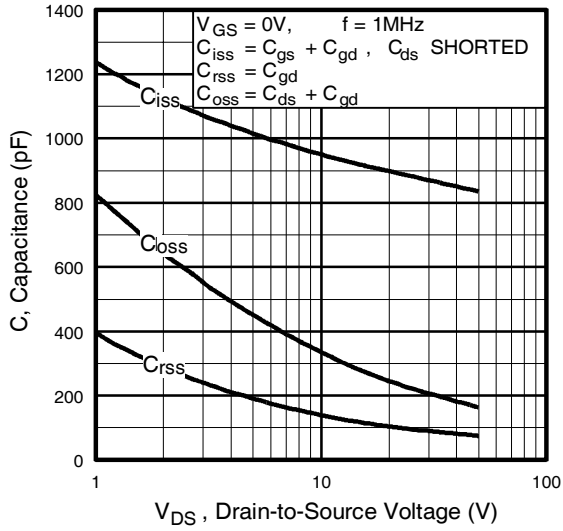


**Fig 3.** Typical Transfer Characteristics

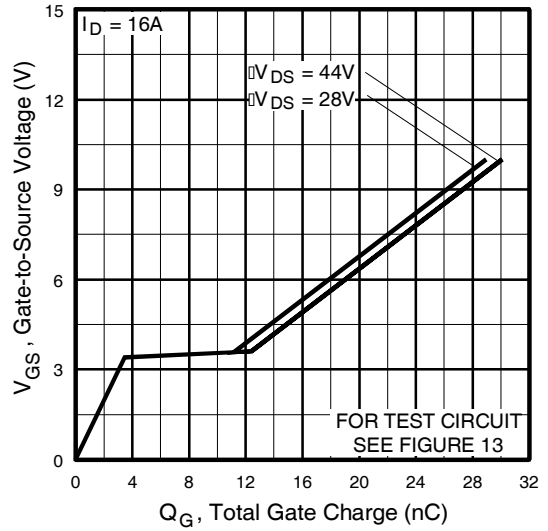


**Fig 4.** Normalized On-Resistance Vs. Temperature

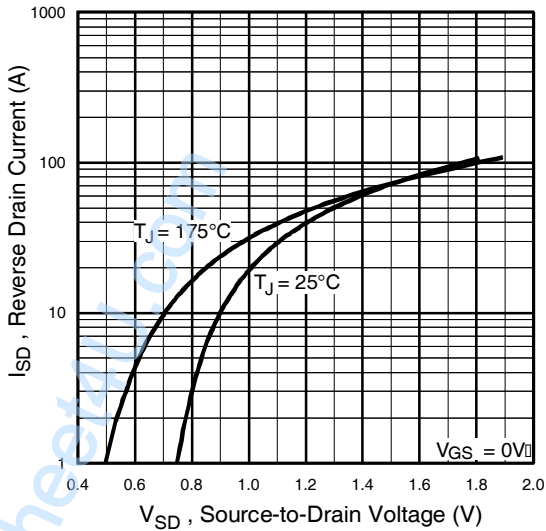
# IRLZ34NPbF



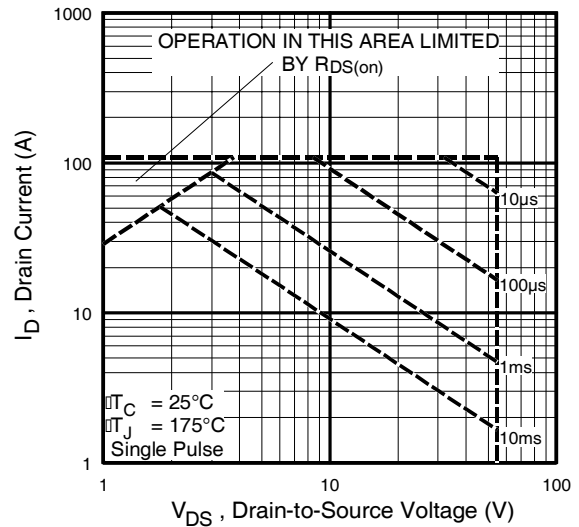
**Fig 5.** Typical Capacitance Vs. Drain-to-Source Voltage



**Fig 6.** Typical Gate Charge Vs. Gate-to-Source Voltage



**Fig 7.** Typical Source-Drain Diode Forward Voltage



**Fig 8.** Maximum Safe Operating Area

www.DataSheet4U.com

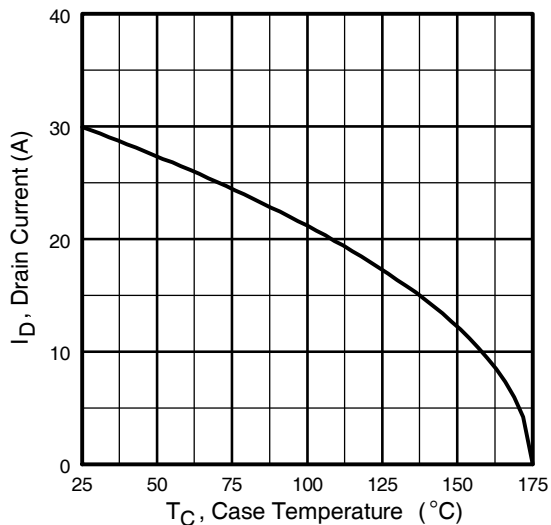


Fig 9. Maximum Drain Current Vs. Case Temperature

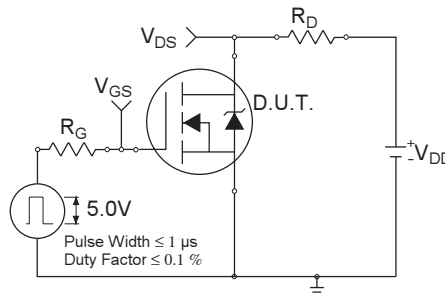


Fig 10a. Switching Time Test Circuit

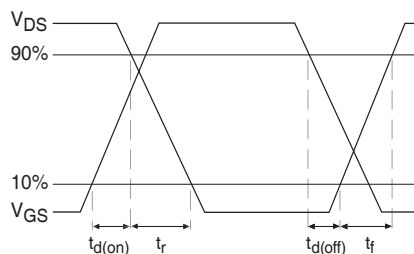


Fig 10b. Switching Time Waveforms

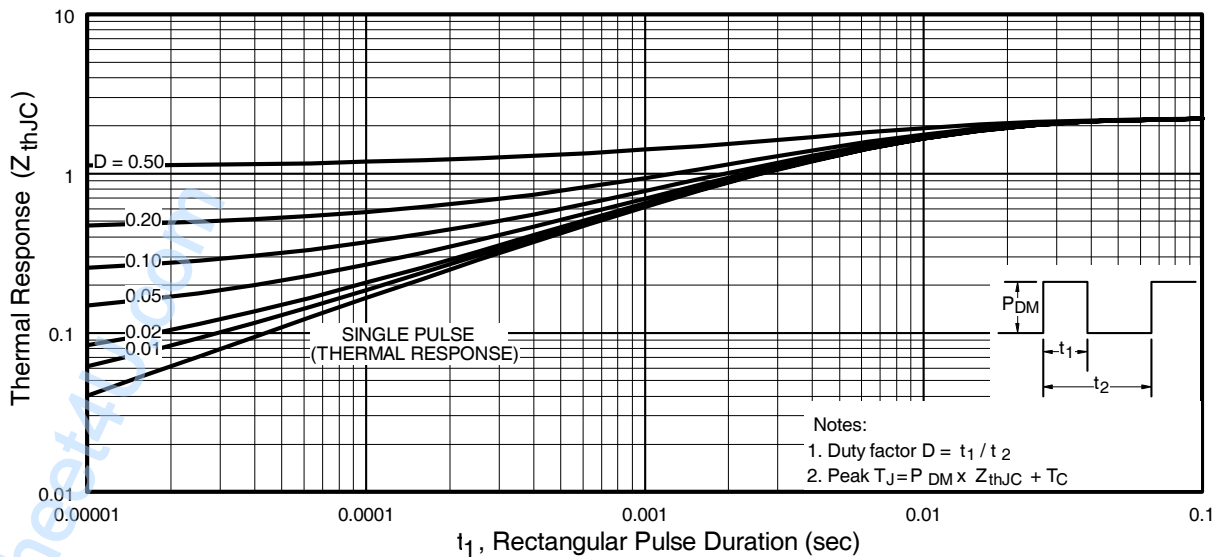
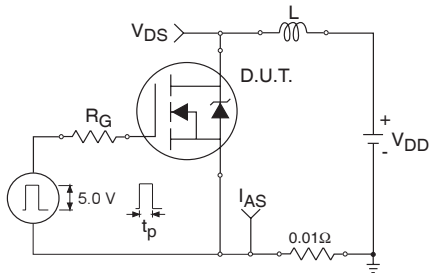


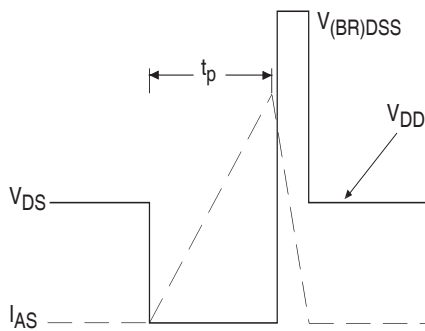
Fig 11. Maximum Effective Transient Thermal Impedance, Junction-to-Case

# IRLZ34NPbF

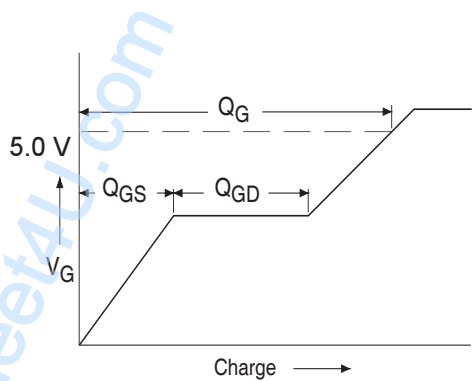
International  
**IR** Rectifier



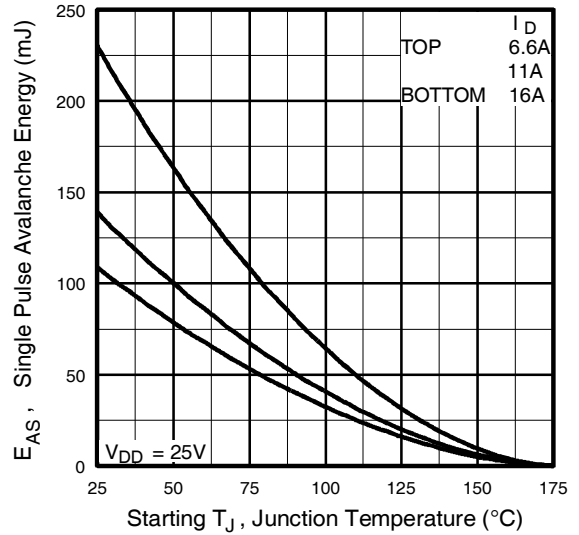
**Fig 12a.** Unclamped Inductive Test Circuit



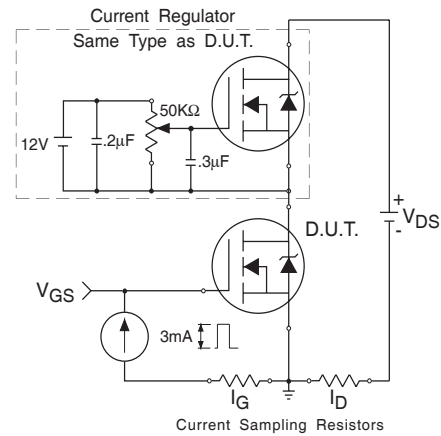
**Fig 12b.** Unclamped Inductive Waveforms



**Fig 13a.** Basic Gate Charge Waveform



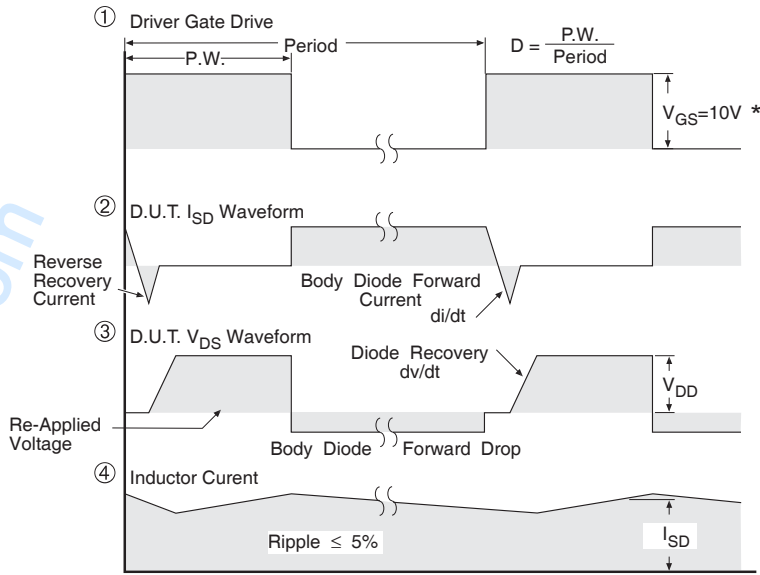
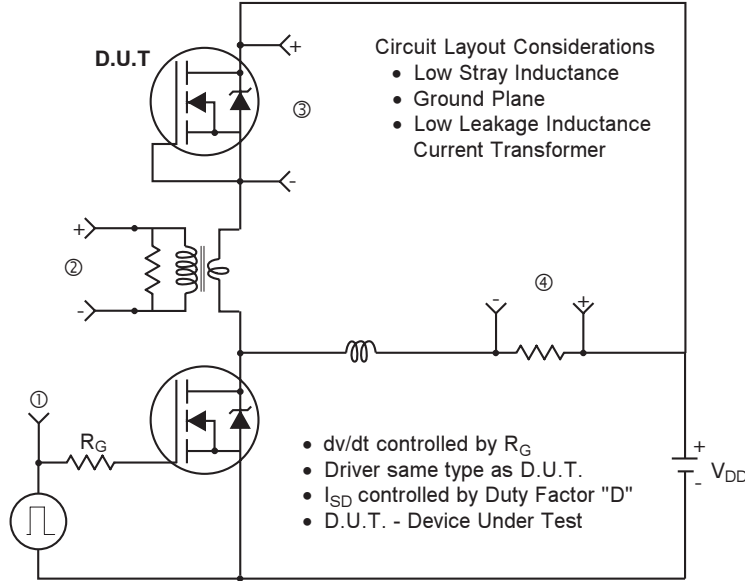
**Fig 12c.** Maximum Avalanche Energy Vs. Drain Current



**Fig 13b.** Gate Charge Test Circuit

www.DataSheet4U.com

**Peak Diode Recovery dv/dt Test Circuit**



\*  $V_{GS} = 5V$  for Logic Level Devices

**Fig 14. For N-Channel HEXFETS**

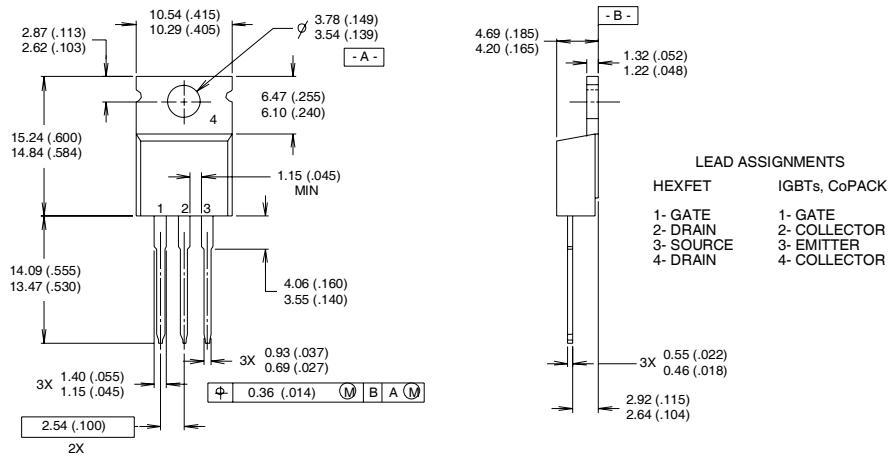
www.DataSheet4U.com

# IRLZ34NPbF



## TO-220AB Package Outline

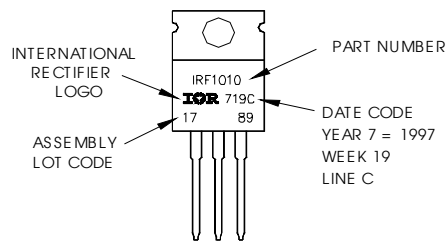
Dimensions are shown in millimeters (inches)



- NOTES:
- 1 DIMENSIONING & TOLERANCING PER ANSI Y14.5M, 1982.
  - 2 CONTROLLING DIMENSION : INCH
  - 3 OUTLINE CONFORMS TO JEDEC OUTLINE TO-220AB.
  - 4 HEATSINK & LEAD MEASUREMENTS DO NOT INCLUDE BURRS.

## TO-220AB Part Marking Information

EXAMPLE: THIS IS AN IRF1010  
 LOT CODE 1789  
 ASSEMBLED ON WW 19, 1997  
 IN THE ASSEMBLY LINE "C"  
**Note:** "P" in assembly line position indicates "Lead-Free"



Data and specifications subject to change without notice.



**IR WORLD HEADQUARTERS:** 233 Kansas St., El Segundo, California 90245, USA Tel: (310) 252-7105  
 TAC Fax: (310) 252-7903

Visit us at [www.irf.com](http://www.irf.com) for sales contact information.11/03

www.DataSheet4U.com