

PRELIMINARY

IRPT1060

POWIRTRAIN™

Integrated Power Stage for 1 hp Motor Drives

- 1 hp (0.75kW) power output
Industrial rating at 150% overload for 1 minute
- 180 - 240V AC input, 50/60Hz
- Available as complete system or as sub-system assemblies

Power Module

- 3-phase rectifier bridge
- 3-phase short circuit rated, ultrafast IGBT inverter
- Low inductance (current sense) shunts in positive and negative DC rail
- NTC temperature sensor
- Pin-to-base plate isolation 2500V rms
- Easy-to-mount two-screw package
- Case temperature range -25°C to 125°C operational

Driver-Plus Board

- DC bus capacitor filter with NTC inrush current limiter
- IR2132 monolithic 3-phase HVIC driver
- On-board +15V and +5V power supply
- MOV surge suppression at input
- DC bus voltage and current feedback
- Protection for short-circuit, earth/ground fault and overtemperature
- Terminal blocks for 3-phase input and output connections

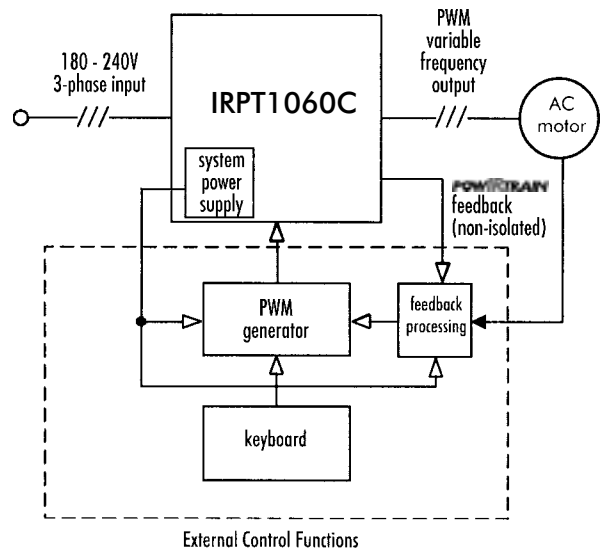
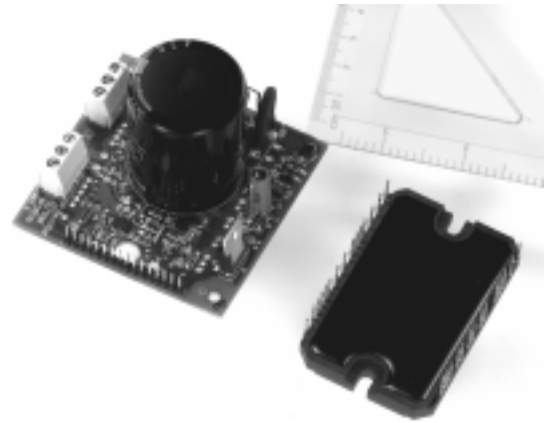

Figure 1. The IRPT1060C **POWIRTRAIN** within a motor control system

System Description

The IRPT1060C **POWERTRAIN** provides the complete conversion function for a 1hp (0.75kW) variable frequency, variable voltage, AC motor controller. The **POWERTRAIN** combines a power module IRPT1060A with a Driver-Plus Board IRPT1060D. Figure 1 shows the block diagram of the **POWERTRAIN** within an AC motor control system.

The power module contains a 3-phase input bridge rectifier, 3-phase IGBT inverter, current sense shunts, and a thermistor. It is designed for easy mounting to a heat sink. The Driver-Plus Board contains DC link capacitors, capacitor soft charge function using NTC thermistor, surge suppression MOVs, IGBT gate drivers, DC bus voltage and current feedback signals, protection circuitry and local power supply. It is designed to mate with a controller board through a single row header. Terminal blocks are provided on the Driver-Plus Board for all end user line input and motor output.

Output power is Pulse-Width Modulated (PWM) 3-phase, variable frequency, variable voltage controlled by an externally generated user-provided PWM controller for inverter IGBT switching. The power supply offers the user non-isolated 5V and 15V to power the micro-controller.

The IRPT1060C offers several benefits to the drive manufacturer listed below:

- It greatly simplifies component selection, design of layout, interconnection, gate drive, local power supply, thermal sensing, current sensing and protection.
- Gate drive and protection circuits are designed to closely match the operating characteristics of the power semiconductors. This allows power losses to be minimized and power rating to be maximized to a greater extent than is possible by designing with individual components.
- It reduces the effort of calculating and evaluating power semiconductor losses and junction temperature.
- It reduces the manufacturer's part inventory and simplifies assembly.

*[**POWERTRAIN** specifications and ratings are given for system input and output voltage and current, power losses and heat sink requirements over a range of operating conditions.*

***POWERTRAIN** system ratings are verified by IR in final testing.]*

The IRPT1060A Power Module

The IRPT1060A Power Module, shown in figure 2, is a chip and wire epoxy encapsulated module. It houses input rectifiers output inverter, current sense shunts and NTC thermistor. The 3-phase **input bridge rectifiers** are rated at 800V. The inverter section employs 600V, **short circuit rated, ultrafast IGBTs** and **ultrafast freewheeling diodes**. Current sensing is achieved through **45mΩ low inductance shunts** provided in the positive and negative DC bus rail. The **NTC thermistor** provides temperature sensing capability. The lead spacing on the power module meets UL840 pollution level 3 requirements.

The power circuit and layout within the module are carefully designed to minimize inductance in the power path, to reduce noise during inverter operation and to improve the inverter efficiency. The Driver-Plus Board required to run the inverter can be soldered to the power module pins, thus minimizing assembly and alignment. The power module is designed to be mounted to a heat sink with two screw mount positions, in order to insure good thermal contact between the module substrate and the heat sink.

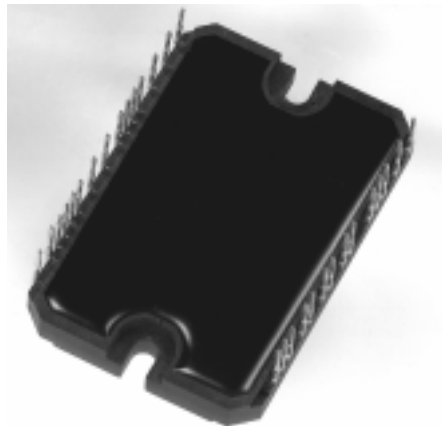

Figure 2. IRPT1060A Power Module

The IRPT1060D Driver-Plus Board

The IRPT1053D Driver-Plus board, shown in figure 3, houses surge suppression MOVs on input, a switching power supply, a DC bus filter capacitor with NTC inrush current limiter, an IR2132J monolithic 3-phase driver IC, and protection and sensing circuitry.

The inverter **gate drive circuit**, implemented with an IR2132J monolithic 3-phase HVIC driver, delivers on/off gate drive signals to the IGBTs' gates, corresponding with input PWM control signals $\overline{IN1}$ through $\overline{IN6}$. After power-up, \overline{RESET} pin on the J3 connector must be held low (with open collector configuration) for at least 2 μ sec while all PWM signals, $\overline{IN1}$ through $\overline{IN6}$ are held high (off condition). A latch in the protection circuitry is set high during a fault condition to trip the IR2132J's internal latch and shut down all PWM output gate drive signals and cause the FAULT output pin on IR2132J to set low and light the LED. The Fault diagnostic is an active low, open drain output with a pull-up resistor. This signal is provided on the J3 connector for **fault** feedback to external control logic.

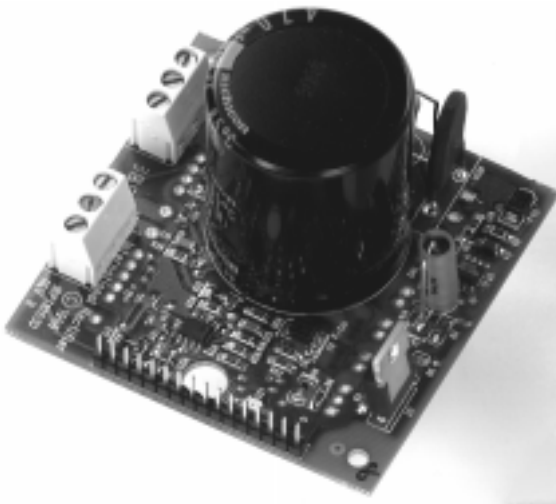

Figure 3. IRPT1060D Driver-Plus Board

The **protection circuitry** receives current signals from shunts in positive and negative DC bus rail for **earth/ground fault** and **short-circuit** conditions. Any earth-fault signal is fed through an opto-isolator to the protection circuitry. Current signal from negative DC bus rail is provided on the J3 connector as **current feedback**, I_{FB} (0.045V/A). If filtering of this signal is required, it should be done by adding a high-impedance buffer stage between signal and filter. DC bus voltage is scaled down to provided a voltage signal on the J3 connector as **voltage feedback**, V_{FB} (0.023 x Bus voltage). Thermal sense signal for **over-temperature** protection is obtained from a thermistor housed inside the power module. The thermistor activates the latch if the temperature of the power module's IMS substrate exceeds a set level.

The system is designed for 150% overload for one minute while operating with the specified heat sink. The external microcontroller should shut off PWM signals if the overload condition persists for more than one minute.

The **switching power supply** employs the IR2152S self-oscillating driver chip in a buck regulator topology to deliver nominal 15V and 5V DC outputs, referenced to the negative DC bus (N). The power supply feeds the gate drive and protection circuits. The 15V and 5V outputs are available on the control interface connector's (J3) V_{CC} and V_{DD} pins for external microprocessor and control logic supply.

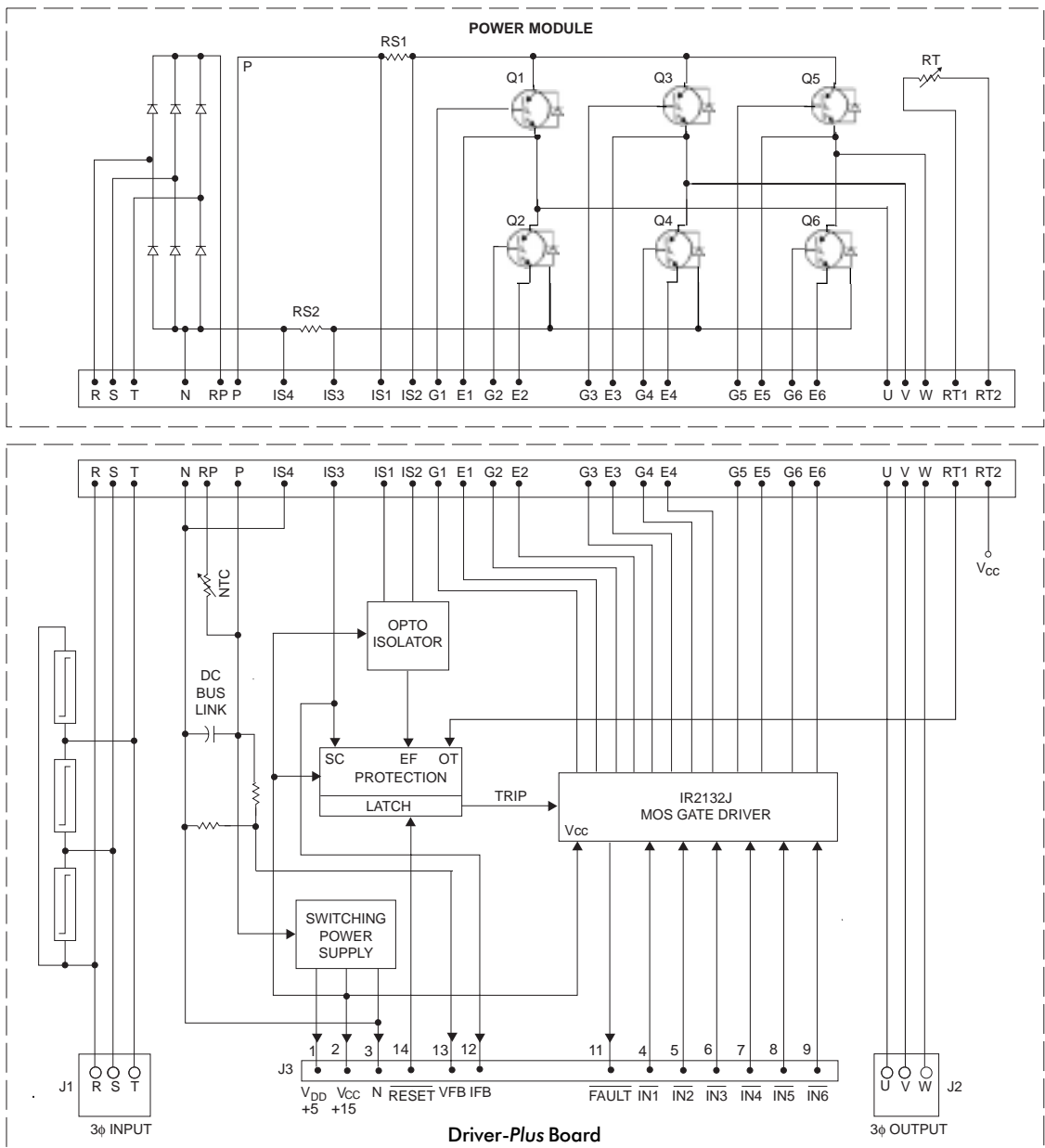

Figure 4. IRPT1060C Basic Architecture

Specifications

PARAMETERS	VALUES	CONDITIONS
Input Power		
Voltage	220V, -15%, +10%, 3-phase	
Frequency	50/60Hz	
Input current	6.2 Arms @ nominal output 100 A peak	$T_A = 40^\circ\text{C}$, $R_{thSA} = 1.38^\circ\text{C/W}$ Initial bus capacitor charging
Output Power		
Voltage	0 - 230V	defined by external PWM control
Nominal Motor hp (kW)	1hp (0.75kW) nominal full load power 150% overload for 1 minute	$V_{in} = 230\text{V}$, $f_{pwm} = 4\text{kHz}$, $f_o = 60\text{Hz}$ $T_A = 40^\circ\text{C}$, $R_{thSA} = 1.38^\circ\text{C/W}$ Z_{thSA} limits ΔT_c to 10°C during overload
Nominal motor current	4.4A nominal full load current 6.6A 150% overload for 1 minute	
Control Inputs		
PWM input signals $\overline{IN1} \dots \overline{IN6}$	5V maximum, active low	CMOS, LSTTL compatible, open collector
Pulse deadtime	0.8 μsec typ. deadtime set by IR2132J	max. deadtime set by external controller
Minimum input pulse width	1 μsec	
RESET	open collector, active low	pin 14 of control interface connector pull down for $\ominus 2\mu\text{sec}$ to release latch
Protection		
Output current trip level	30A, $\pm 10\%$	$T_C = 25^\circ\text{C}$
Earth/gnd fault current trip level	36A, $\pm 10\%$	$T_C = 25^\circ\text{C}$
Overtemperature trip level	$100^\circ\text{C} \pm 5\%$	Case temperature
Maximum DC link voltage	400V	user to ensure rating not exceeded for > 30 sec.
Short circuit shutdown time	2.5 μsec typical	output terminals shorted
Feedback Signals		
Current feedback (IFB)	0.045V/A	
DC bus voltage feedback (VFB)	0.023 typical V/V_{BUS}	
Fault feedback ($\overline{\text{Fault}}$)	5V, active low	
On Board Power Supply		
V_{CC}	15V, $\pm 10\%$	
V_{DD}	5V, $\pm 5\%$	
$I_{CC} + I_{DD}$	60mA	max. limit specified is available on control interface connector J3 for external use
Module		
Isolation voltage	2500V rms	pin to base plate isolation, 60Hz, 1 minute
Operating case temperature	-25°C to 125°C	95%RH max. (non-condensing)
Mounting torque	1 Nm	M4 screw type
System Environment		
Ambient operating temp. range	0 to 40°C	95%RH max. (non-condensing)
Storage temperature range	-25 to 60°C	

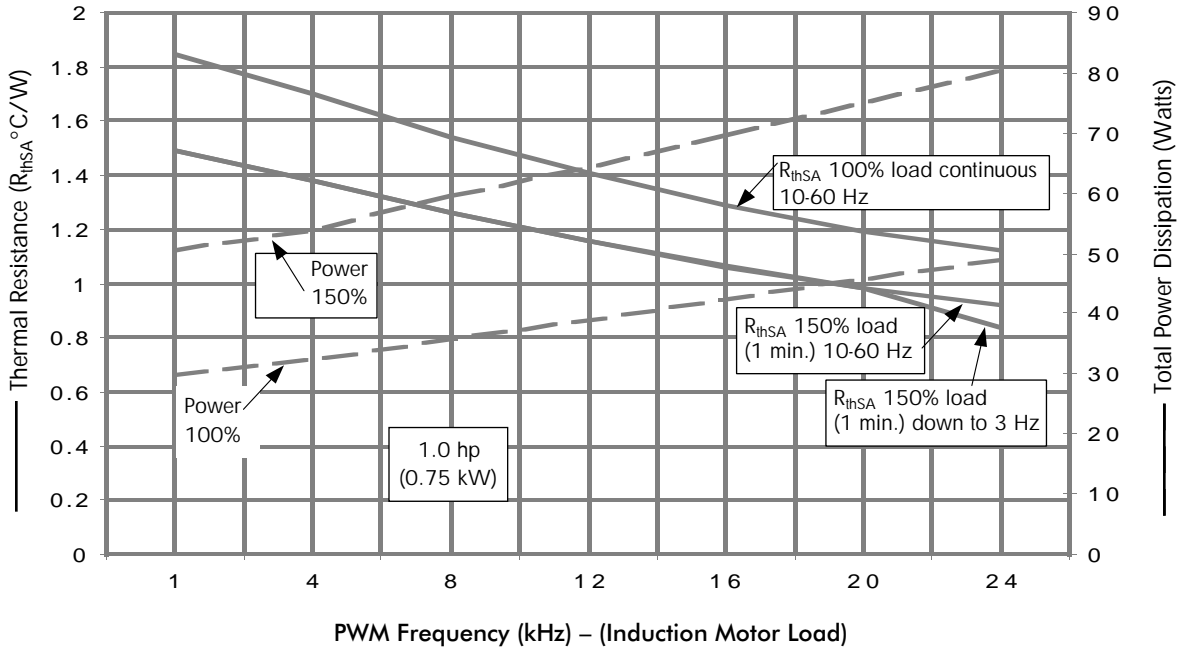

Figure 5a. 1hp/4.4A output Heat sink Thermal Resistance and Power Dissipation vs. PWM Frequency

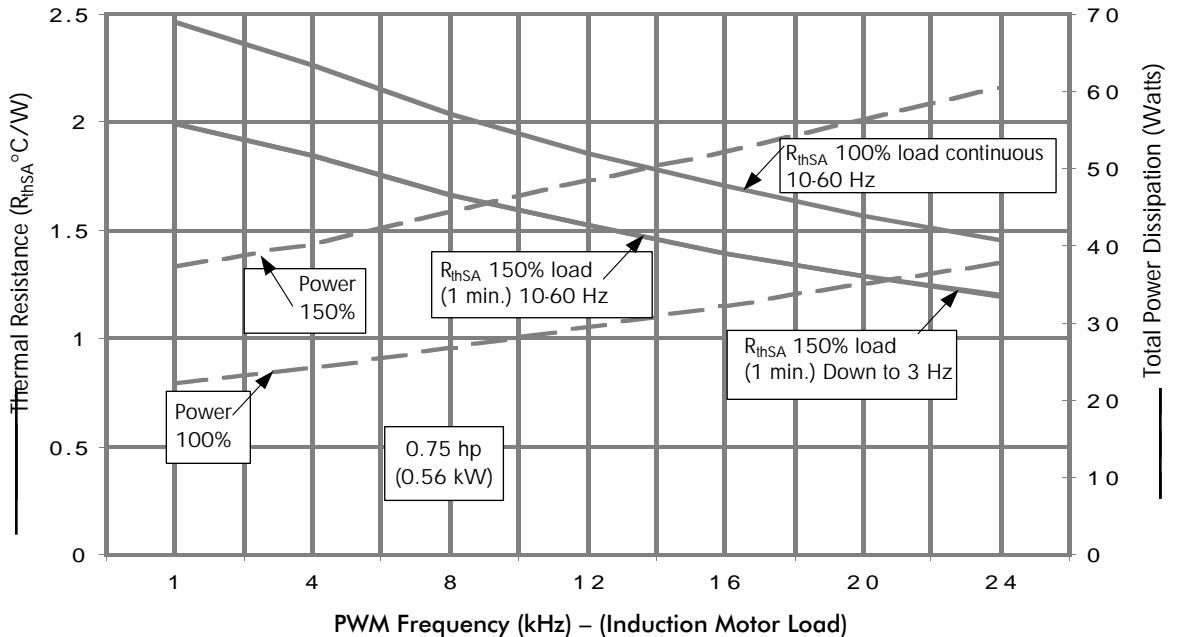

Figure 5b. 0.75hp/3.5A output Heat sink Thermal Resistance and Power Dissipation vs. PWM Frequency

NOTE: For figures 5a and 5b – Operating Conditions: $V_{in}=230V_{rms}$, $M=1.15$, $P.F.=0.8$, $T_A=40^{\circ}C$, Z_{thSA} limits ΔT rise during 1 minute overload to $10^{\circ}C$.

Mounting, Hookup and Application Instructions

Mounting

1. Remove all particles and grit from the heat sink and power substrate.
2. Spread a .004" to .005" layer of silicone grease on the heat sink, covering the entire area that the power substrate will occupy. Recommended heat sink flatness is .001 inch/inch and Total Indicator Readout (TIR) of .003 inch below substrate
3. Place the power substrate onto the heat sink with the mounting holes aligned and press it firmly into the silicone grease.
4. Place the 2 M4 mounting screws through the PCB and power module and into the heat sink and tighten the screws to 1 Nm torque.

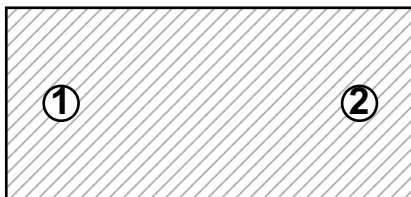

Figure 6. Power Module Mounting Screw Sequence

Control Connections

All input and output control connections are made via a 16-terminal female connector to J3.

Power Connections

3-phase input connections are made to terminals R,S and T (J1). Inverter output terminal connections are made to terminals U,V and W (J2).

Power-Up Procedure

When 3-phase input power is first switched on, PWM inputs to the IRPT1053C must be inhibited (held high) until the protection latch circuitry is reset. To reset this latch before inverter start-up, RESET pin on J3 connector must be pulled down low for at least 2 μ sec. This will set the Fault feedback signal on J3 high. Now, the PWM input signals can be applied for inverter start-up.

Power-Down Procedure

The following sequence is recommended for normal power down:

1. reduce motor speed by PWM control
2. inhibit PWM inputs
3. disconnect main power.

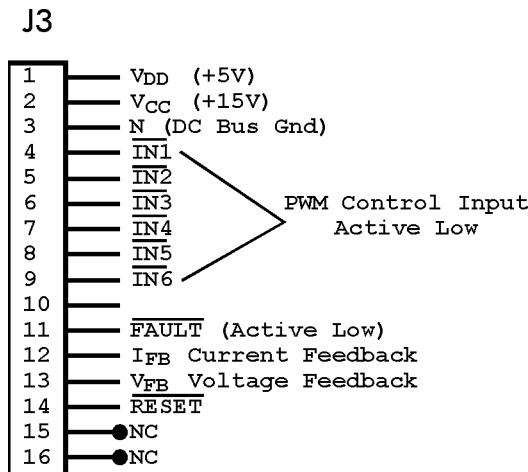

Figure 7a. Control Signal Connector

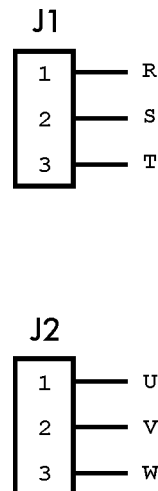

Figure 7b. Input and Output Terminal Blocks

IRPT1060D Mechanical Specifications

NOTE: Dimensions are in inches [millimeters]

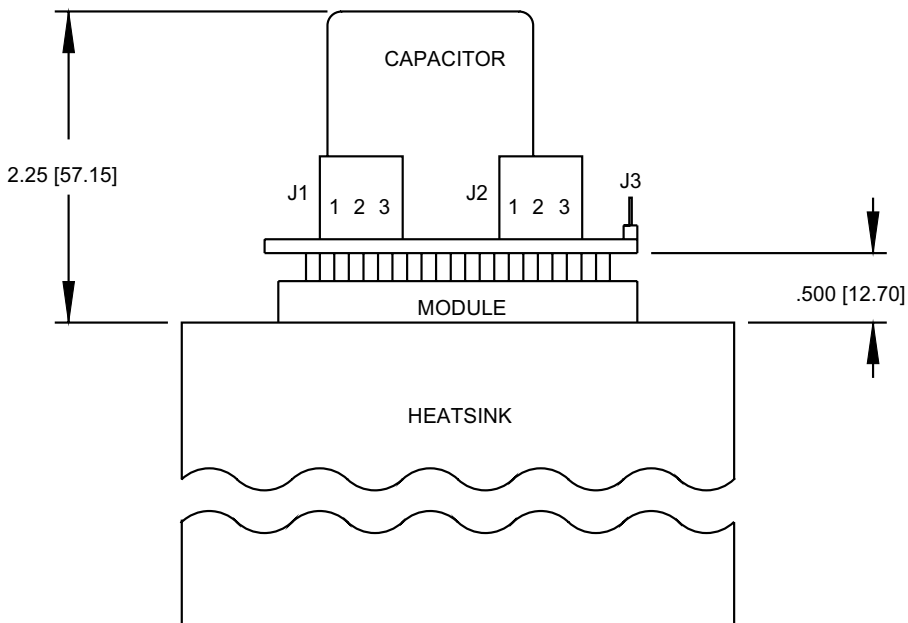
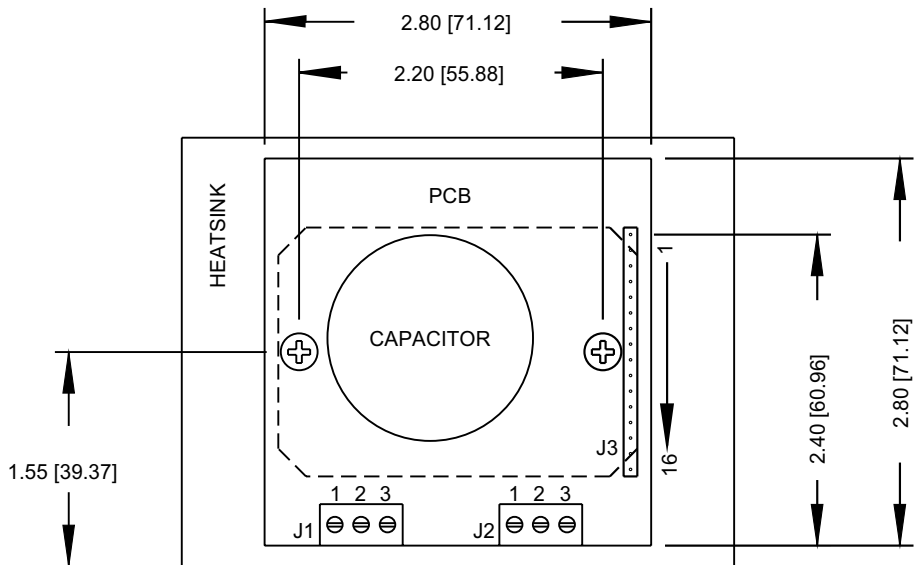

Figure 8a

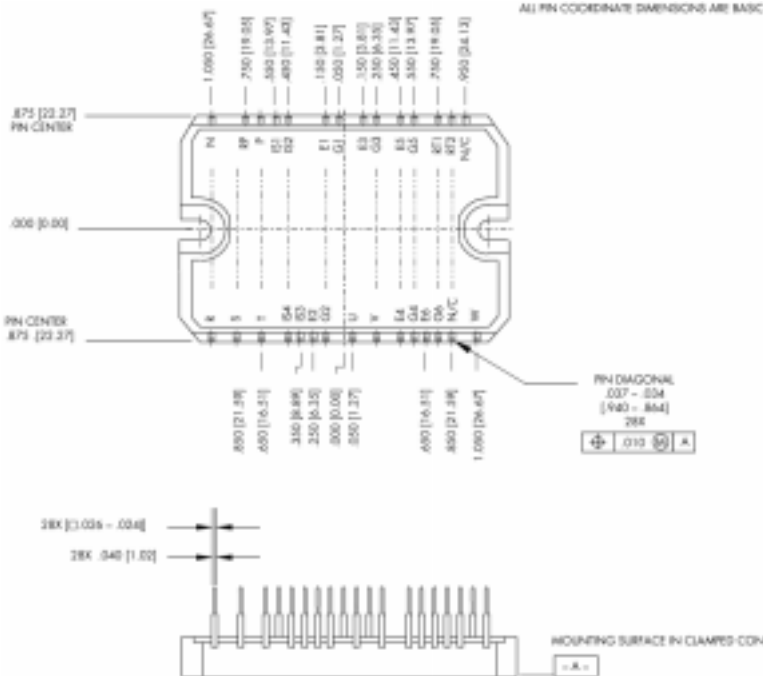
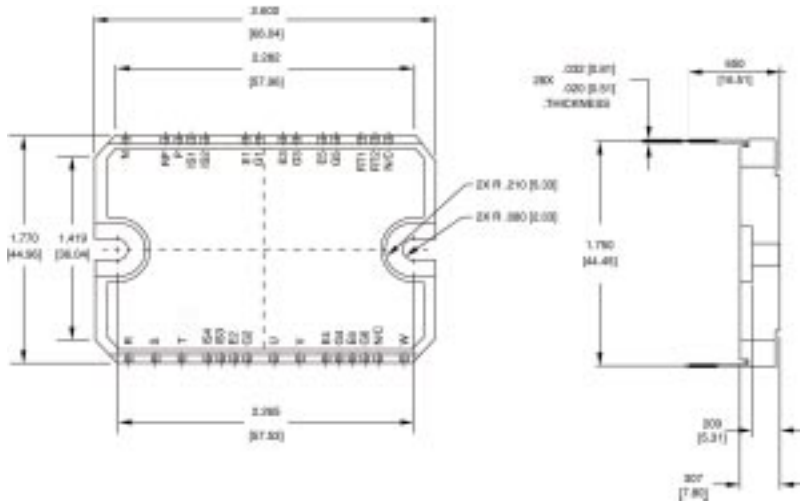

Figure 8b

Part Number Identification and Ordering Instructions

IRPT1060A Power Module

Chip and wire epoxy encapsulated module with 800V rectifiers, 600V short-circuit rated, ultra-fast IGBT inverter with ultra-fast freewheeling diodes, temperature sensing NTC thermistor and current-sensing low-inductance shunts.

IRPT1060C **POWIRTRAIN**

Integrated Power Module (IRPT1060A) and Driver-Plus Board (IRPT1060D) pre-assembled and tested to meet all system specifications.

IRPT1060D Driver-Plus Board

Printed Circuit board assembled with DC link capacitors, NTC in-rush limiting thermistor, high-power terminal blocks, surge suppression MOVs, IGBT gate drivers, protection circuitry and low power supply. The PCB is functionally tested with standard power module to meet all system specifications.

IRPT1060E Design Kit

Complete **POWIRTRAIN** (IRPT1060C) with full set of design documentation including schematic diagram, bill of material, mechanical layout, schematic files, Gerber files and design tips.

Functional Information

CAUTION All control logic is referenced to negative power bus which is live with respect to earth/ground.

Capacitor Soft Charge

A DC bus capacitor is connected to the rectifier bridge output through an NTC. At power-up, the NTC limits the inrush current to 100A. During normal operation current through the NTC reduces its resistance, hence reducing its losses.

System Power Supply

A buck converter designed with IR2152 and operating from the dc bus generates V_{CC} (15V) and V_{DD} (5V) for drive and protection circuits. Both V_{CC} and V_{DD} are available at the control connector to supply microprocessor controls. Total current available from V_{CC} and V_{DD} (I_{CC} and I_D , respectively) is 60mA for external use.

Floating power supplies for high side devices are derived through bootstrap technique, simplifying power supply requirements.

Gate Drive Circuits

Gate drive for the inverter is implemented with an IR2132J monolithic 3-phase HVIC driver. Short circuit buffer power supply counters the voltage drop across a shunt in the negative dc bus, allowing the device to have nominal gate voltage during short circuit and maintaining short circuit current to a detectable level.

The undervoltage circuit monitors the local gate driver power supply voltage and sends a high input signal during undervoltage, setting the latch and inhibiting the PWM input signals.

System Protections

Short circuit is monitored through a shunt in the negative bus, which detects phase-to-phase short circuits and phase-to-earth short circuits (when current flows from earth to negative bus). Voltage drop across the shunt is compared to a pre-set limit and when the current exceeds a nominal value of 30A this protection is activated.

Earth/ground fault from positive bus to earth is detected by the shunt in the positive bus and an opto-coupler. When fault current exceeds a nominal value of 36A, this protection is activated.

Overtemperature is measured by a thermistor mounted close to the inverter section. When the substrate temperature exceeds a nominal value of 100°C, this protection is activated.

If any of the protection features is activated, the TRIP signal goes high and is latched high, activating the internal latch in IR2132J, which turns all gates to the inverter section off, acknowledging to the controller through FAULT and turns on the LED.

Trip Reset

The internal latch of the IR2132J can be reset by holding $\overline{IN2}$, $\overline{IN4}$ and $\overline{IN6}$ OFF simultaneously for a period greater than 12 μ s. The TRIP signal can be removed by pulling down the RESET pin through the open collector device for 2 μ s, this should be done only after $\overline{IN1}$,..., $\overline{IN6}$ are turned OFF.

Interface with system controller

All signals are referred to negative DC bus (N). $\overline{IN1}$,..., $\overline{IN6}$ are TTL/CMOS compatible active low signals. Maximum voltage rating for these signals is 5V. All channels are provided with pull-up resistors and can be used with open collector inputs as well.

FAULT is open collector, active low signal, provided with 47K pull-up resistor. Typical current sink capacity for this pin is 5 mA.

RESET should be applied with open collector device only and only after $\overline{IN1}$,..., $\overline{IN6}$ are turned OFF. Recommended RESET pulse duration is 2 μ s.

V_{DD} is 5V and V_{CC} is 15V output. If 5V output is used with a large external capacitor, a diode should be connected between V_{DD} (anode) and V_{CC} (cathode) to ensure that V_{DD} does not exceed V_{CC} , due to potentially different discharge times for storage capacitors when power is turned OFF.

V_{FB} is scaled down dc bus voltage (0.023 X V_{bus} nominal).

I_{FB} is DC bus current, 0.045V/A nominal. This pin **must not be connected** to circuit ground (N) through low impedance. If filtering of this signal is required, it should be done by adding a high impedance buffer stage between signal and filter.

Heat sink Requirements

Figures 5a and 5b of the IRPT1053 datasheet show the thermal resistance of the heat sink required for various output power levels and PWM switching frequencies. Maximum total losses of the unit are also shown.

This data is based on the following key operating conditions:

- The maximum continuous combined losses of the rectifier and inverter occur at full pulse-width-modulation. These maximum losses set the maximum continuous operating temperature of the heat sink.
- The maximum combined losses of the rectifier and inverter at full pulse-width modulation under overload set

the incremental temperature rise of the heat sink during overload, which is limited to 10°C due to Z_{thSA} .

- The minimum output frequency at which full overload current is to be delivered sets the peak IGBT junction temperatures.
- At low output frequency IGBT junction temperature tends to follow the instantaneous fluctuations of the output current. Thus, peak junction temperature rise increases as output frequency decreases.

Voltage Rise During Braking

The motor will feed energy back to the DC link during electric braking, forcing DC bus voltage to rise above the level defined by input line voltage. Deceleration of the motor must be controlled by appropriate PWM control to keep the DC bus voltage within the rated maximum value.

International
IR Rectifier

WORLD HEADQUARTERS: 233 Kansas St., El Segundo, California 90245, Tel: (310) 322 3331

EUROPEAN HEADQUARTERS: Hurst Green, Oxted, Surrey RH8 9BB, UK Tel: ++ 44 1883 732020

IR CANADA: 7321 Victoria Park Ave., Suite 201, Markham, Ontario L3R 2Z8, Tel: (905) 475 1897

IR GERMANY: Saalburgstrasse 157, 61350 Bad Homburg Tel: ++ 49 6172 96590

IR ITALY: Via Liguria 49, 10071 Borgaro, Torino Tel: ++ 39 11 451 0111

IR FAR EAST: 171 (K&H Bldg.), 30-4 Nishi-ikebukuro 3-Chome, Toshima-ku, Tokyo Japan Tel: 81 3 3983 0086

IR SOUTHEAST ASIA: 315 Outram Road, #10-02 Tan Boon Liat Building, Singapore 0316 Tel: 65 221 8371

<http://www.irf.com/> Data and specifications subject to change without notice. 9/97