

## IS281



### DESCRIPTION

The IS281 series optocoupler consists of an infrared emitting diode optically coupled to an NPN silicon photo transistor.

This device belongs to Isocom Compact Range of Optocouplers.

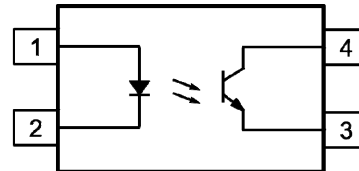

1 Anode  
2 Cathode  
3 Emitter  
4 Collector

### FEATURES

- Half Pitch 1.27mm
- High AC Isolation voltage 3750V<sub>RMS</sub>
- CTR Selections Available
- Wide Operating Temperature Range -55°C to 110°C
- Pb Free and RoHS Compliant
- UL Approval E91231, Model "THP"

### APPLICATIONS

- Switching Mode Power Supply
- Industrial System Controllers
- Measuring Instruments
- Signal Transmission between Systems of Different Potentials and Impedances

### ORDER INFORMATION

- Available in Tape and Reel with 1000pcs per reel

### ABSOLUTE MAXIMUM RATINGS (T<sub>A</sub> = 25°C)

Stresses exceeding the absolute maximum ratings can cause permanent damage to the device.

Exposure to absolute maximum ratings for long periods of time can adversely affect reliability.

#### Input

|                   |      |
|-------------------|------|
| Forward Current   | 50mA |
| Reverse Voltage   | 6V   |
| Power dissipation | 70mW |

#### Output

|  |       |
|--|-------|
| Collector to Emitter Voltage BV <sub>CEO</sub> | 80V   |
| Emitter to Collector Voltage BV <sub>ECO</sub> | 7V    |
| Collector Current                              | 50mA  |
| Power Dissipation                              | 150mW |

#### Total Package

|                                  |                      |
|----------------------------------|----------------------|
| Isolation Voltage                | 3750V <sub>RMS</sub> |
| Total Power Dissipation          | 200mW                |
| Operating Temperature            | -55 to 110 °C        |
| Storage Temperature              | -55 to 150 °C        |
| Lead Soldering Temperature (10s) | 260°C                |

#### ISOCOM COMPONENTS 2004 LTD

Unit 25B, Park View Road West, Park View Industrial Estate  
Hartlepool, Cleveland, TS25 1PE, United Kingdom  
Tel : +44 (0)1429 863 609 Fax : +44 (0)1429 863 581  
e-mail : sales@isocom.co.uk  
<http://www.isocom.com>

#### ISOCOM COMPONENTS ASIA LTD

Hong Kong Office  
Block A, 8/F, Wah Hing Industrial Mansion  
36 Tai Yau Street, San Po Kong, Kowloon, Hong Kong  
Tel : +852 2995 9217 Fax : +852 8161 6292  
e-mail : sales@isocom.com.hk

## IS281

### ELECTRICAL CHARACTERISTICS ( $T_A = 25^\circ\text{C}$ unless otherwise specified)

#### INPUT

| Parameter            | Symbol   | Test Condition                   | Min | Typ. | Max | Unit          |
|----------------------|----------|----------------------------------|-----|------|-----|---------------|
| Forward Voltage      | $V_F$    | $I_F = 20\text{mA}$              |     | 1.2  | 1.4 | V             |
| Reverse Current      | $I_R$    | $V_R = 4\text{V}$                |     |      | 10  | $\mu\text{A}$ |
| Terminal Capacitance | $C_{IN}$ | $V = 0\text{V}, f = 1\text{KHz}$ |     | 30   | 250 | pF            |

#### OUTPUT

| Parameter                           | Symbol     | Test Condition                          | Min | Typ. | Max | Unit |
|-------------------------------------|------------|---|-----|------|-----|------|
| Collector-Emitter Breakdown Voltage | $BV_{CEO}$ | $I_C = 0.1\text{mA}, I_F = 0\text{mA}$  | 80  |      |     | V    |
| Emitter-Collector Breakdown Voltage | $BV_{ECO}$ | $I_E = 0.1\text{mA}, I_F = 0\text{mA}$  | 7   |      |     | V    |
| Collector-Emitter Dark Current      | $I_{CEO}$  | $V_{CE} = 20\text{V}, I_F = 0\text{mA}$ |     |      | 100 | nA   |

## IS281

### ELECTRICAL CHARACTERISTICS ( $T_A = 25^\circ\text{C}$ unless otherwise specified)

#### COUPLED

| Parameter                            | Symbol        | Test Condition  | Min | Typ. | Max | Unit          |  |
|--------------------------------------|---------------|---|-----|------|-----|---------------|--|
| Current transfer ratio               | CTR           | $I_F = 5\text{mA}, V_{CE} = 5\text{V}$                  |     |      |     | %             |  |
|                                      |               | IS281   | 50  |      | 600 |               |  |
|                                      |               | IS281A  | 80  |      | 160 |               |  |
|                                      |               | IS281B  | 130 |      | 260 |               |  |
|                                      |               | IS281C  | 200 |      | 400 |               |  |
|                                      |               | IS281D  | 300 |      | 600 |               |  |
|                                      |               | IS281E  | 100 |      | 200 |               |  |
|                                      |               | IS281F  | 150 |      | 300 |               |  |
|                                      |               | IS281GB   | 100 |      | 600 |               |  |
|                                      |               | $I_F = 10\text{mA}, V_{CE} = 5\text{V}$                 |     |      |     |               |  |
|                                      |               | IS281H  | 40  |      | 80  |               |  |
|                                      |               | IS281I  | 63  |      | 125 |               |  |
|                                      |               | IS281J  | 100 |      | 200 |               |  |
|                                      |               | IS281K  | 160 |      | 320 |               |  |
| IS281GR                              | 100           |   | 300 |      |     |               |  |
| Collector-Emitter Saturation Voltage | $V_{CE(sat)}$ | $I_F = 10\text{mA}, I_C = 1\text{mA}$                   |     | 0.1  | 0.2 | V             |  |
| Floating Capacitance                 | $C_f$         | $V_F = 0\text{V}, f = 1\text{MHz}$                      |     | 0.3  |     | pF            |  |
| Output Rise Time                     | $t_r$         | $V_{CE} = 2\text{V}, I_c = 2\text{mA}, R_L = 100\Omega$ |     | 6    | 18  | $\mu\text{s}$ |  |
| Output Fall Time                     | $t_f$         | $V_{CE} = 2\text{V}, I_c = 2\text{mA}, R_L = 100\Omega$ |     | 6    | 18  | $\mu\text{s}$ |  |

#### ISOLATION

| Parameter                 | Symbol    | Test Condition   | Min                | Typ. | Max | Unit      |
|---------------------------|-----------|--|--------------------|------|-----|-----------|
| Isolation Voltage         | $V_{ISO}$ | R.H. = 40% to 60%, $t = 1\text{ min}$<br>Note 1          | 3750               |      |     | $V_{RMS}$ |
| Input - Output Resistance | $R_{I-O}$ | $V_{I-O} = 500\text{VDC}$<br>R.H. = 40% to 60%<br>Note 1 | $5 \times 10^{10}$ |      |     | $\Omega$  |

Note 1 : Measured with input leads shorted together and output leads shorted together.

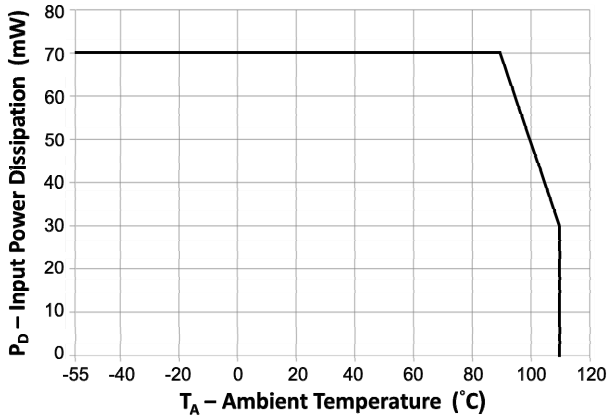

Fig 1 Input Power Dissipation vs Ambient Temperature

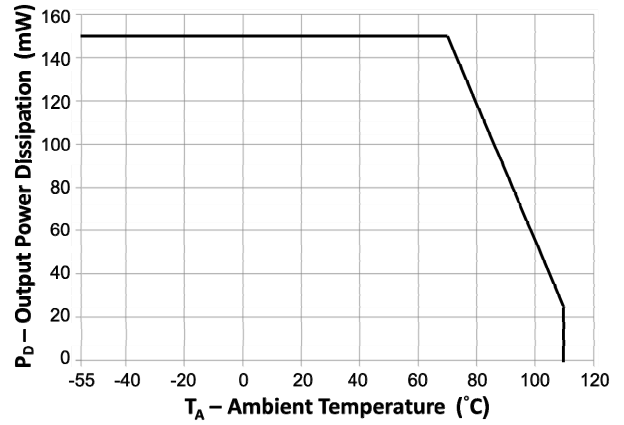

Fig 2 Output Power Dissipation vs Ambient Temperature

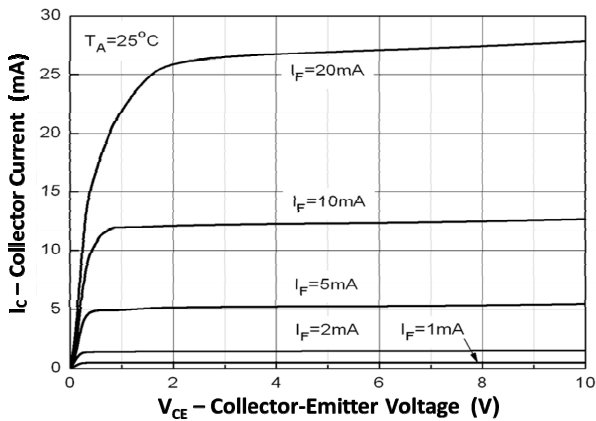

Fig 3 Collector Current vs Collector-Emitter Voltage (1)

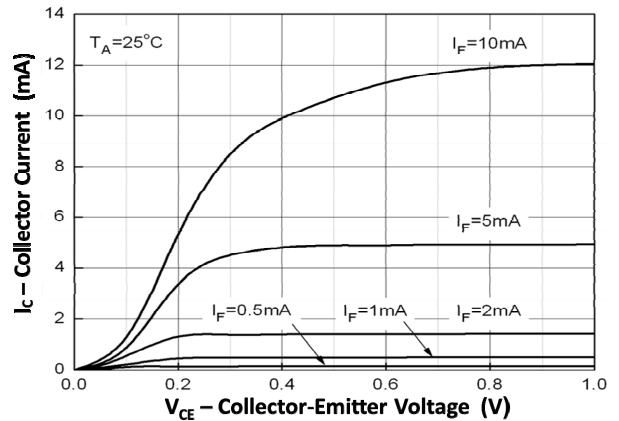

Fig 4 Collector Current vs Collector-Emitter Voltage (2)

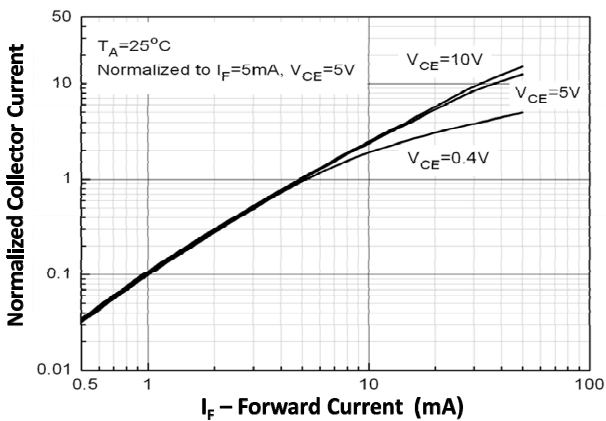

Fig 5 Normalized Collector Current vs Forward Voltage

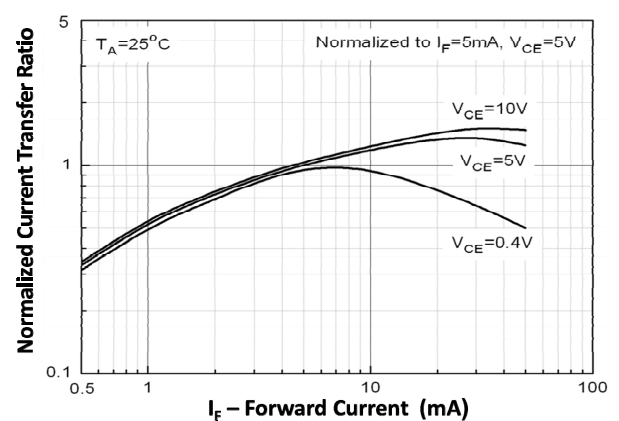

Fig 6 Collector Current Transfer Ratio vs Forward Current

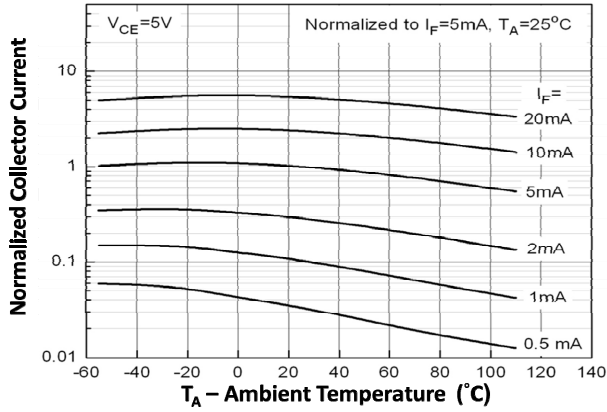

Fig 7 Normalized Collector Current vs Ambient Temperature

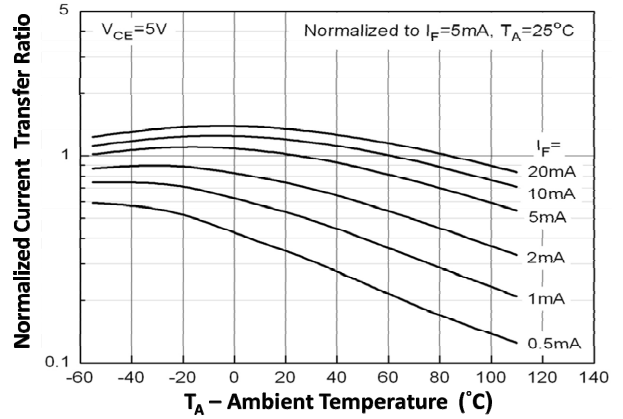

Fig 8 Normalized Current Transfer Ratio vs Ambient Temperature

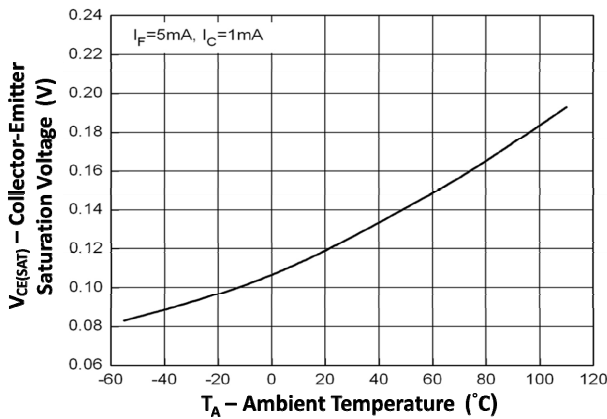

Fig 9 Collector-Emitter Voltage vs Ambient Temperature

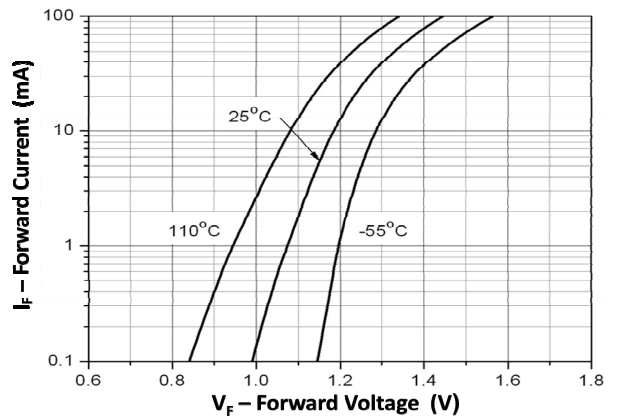

Fig 10 Forward Current vs Forward Voltage

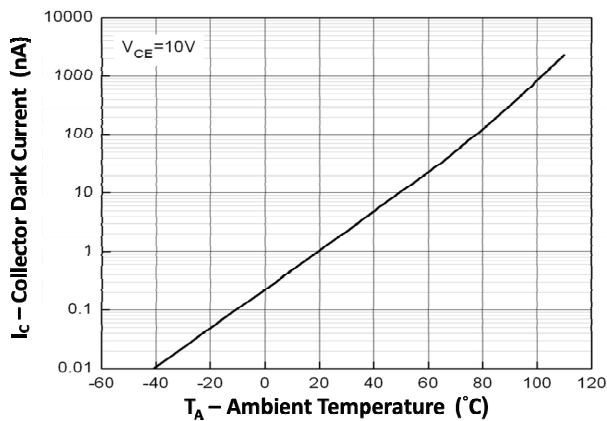

Fig 11 Collector Dark Current vs Ambient Temperature

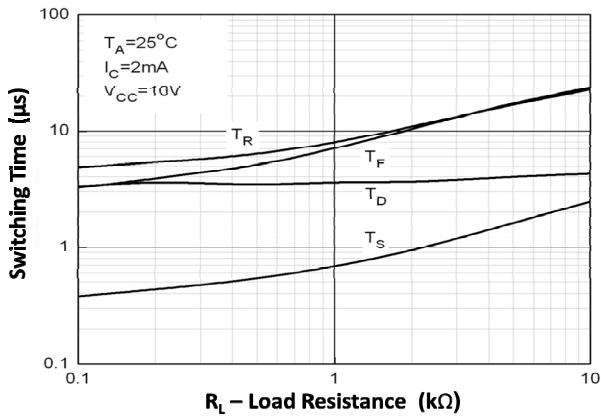
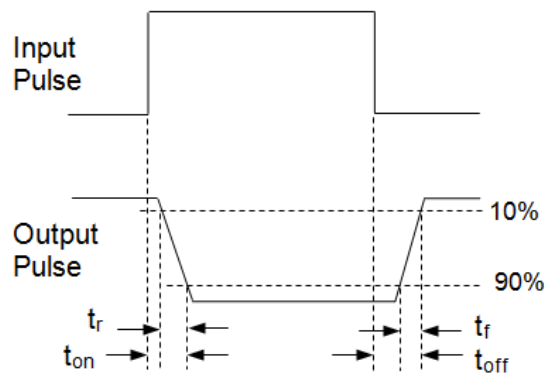
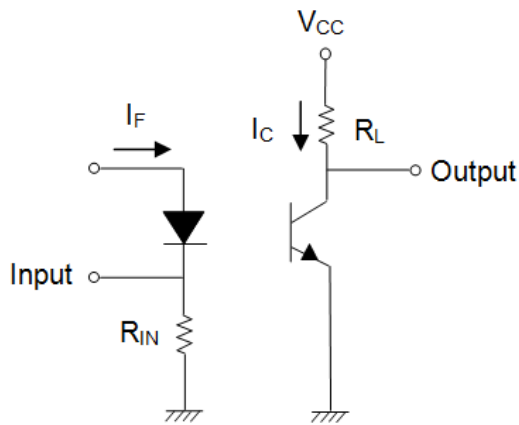

Fig 12 Switching Time vs Load Resistance



Switching Time Test Circuit

## IS281

### ORDER INFORMATION

| IS281         |  |                           |                   |
|---------------|--|---------------------------|-------------------|
| After PN      | PN   | Description               | Packing quantity  |
| None          | IS281  | Surface Mount Tape & Reel | 1000 pcs per reel |
| Any CTR Grade | IS281A, IS281B, IS281C, IS281D, IS281E, IS281F, IS281H, IS281I, IS281J, IS281K, IS281GR, IS281GB | Surface Mount Tape & Reel | 1000 pcs per reel |

**NOTE : Multiple Grades may be supplied to meet the requested specification**

### DEVICE MARKING



THP\_ denotes Device Part Number where “\_” denotes CTR Grade

I denotes Isocom

Y denotes 1 digit Year code

WW denotes 2 digit Week code

|               |               |                         |
|---------------|---------------|-------------------------|
| <b>Note :</b> | <b>Device</b> | <b>Optional Marking</b> |
|               | IS281         | THP1                    |
|               | IS281B        | THP3                    |
|               | IS281F        | THP10                   |

# IS281

## PACKAGE DIMENSIONS (mm)

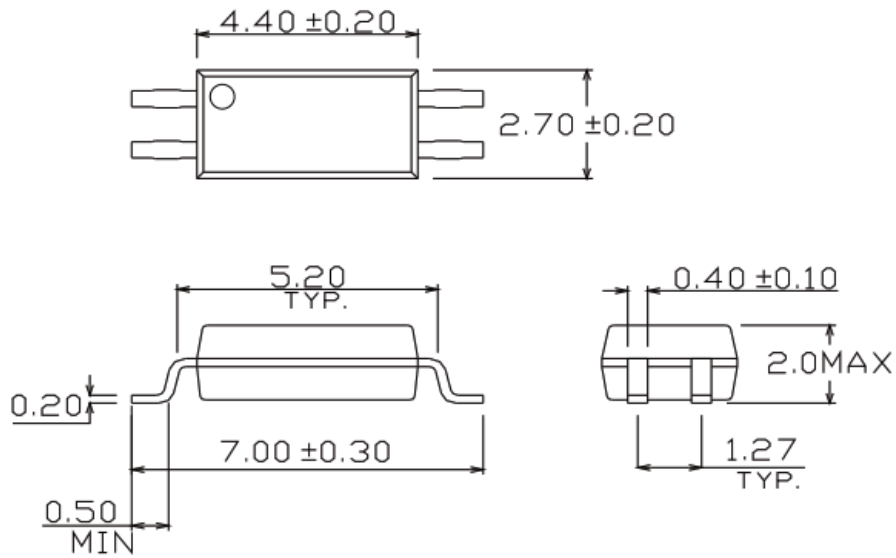

## RECOMMENDED SOLDER PAD LAYOUT (mm)

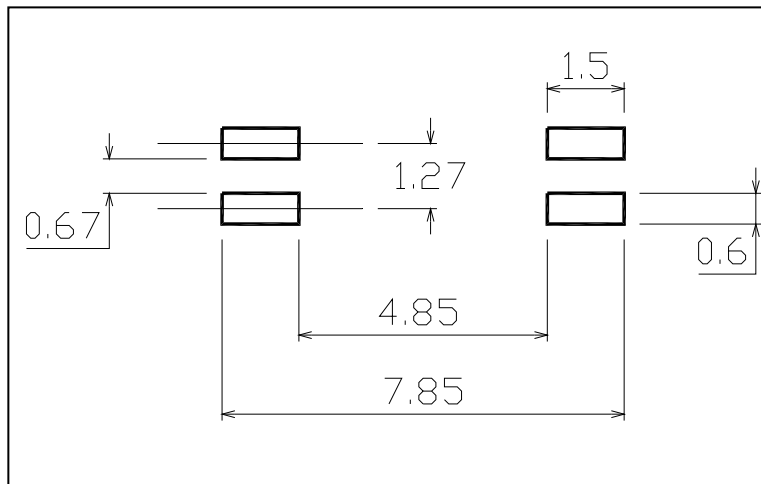



Tape and Reel Packaging

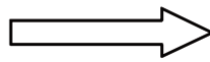
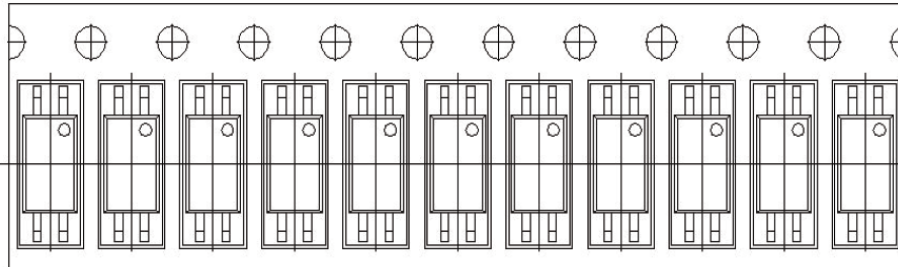

Direction of feed from reel

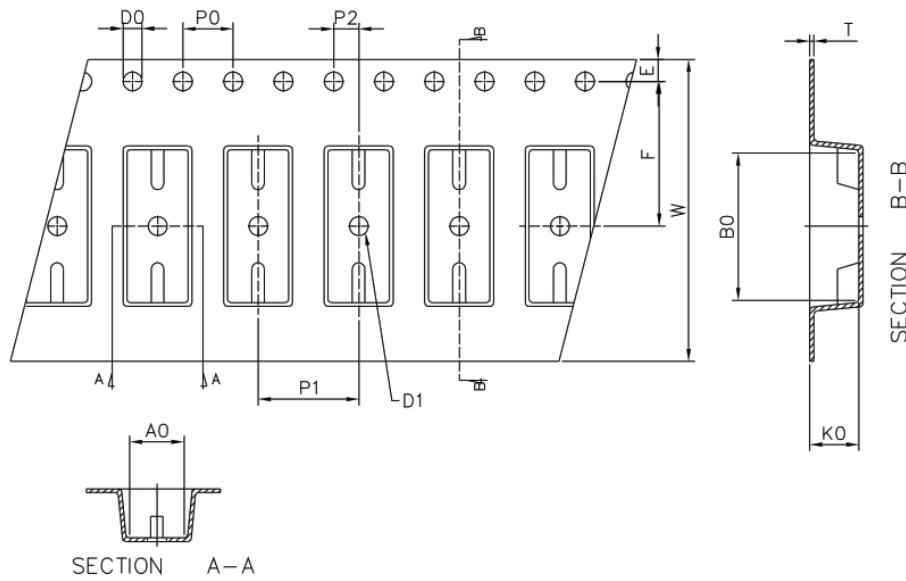

|                |           |           |             |           |           |           |
|----------------|-----------|-----------|-------------|-----------|-----------|-----------|
| Dimension No.  | <b>A0</b> | <b>B0</b> | <b>D0</b>   | <b>D1</b> | <b>E</b>  | <b>F</b>  |
| Dimension( mm) | 3.00±0.10 | 7.45±0.10 | 1.50+0.1/-0 | 1.50±0.10 | 1.75±0.10 | 5.5±0.10  |
| Dimension No.  | <b>P0</b> | <b>P1</b> | <b>P2</b>   | <b>t</b>  | <b>W</b>  | <b>K0</b> |
| Dimension (mm) | 4.00±0.15 | 4.00±0.10 | 2.00±0.10   | 0.30±0.05 | 12.1±0.2  | 2.45±0.1  |

**IR REFLOW SOLDERING TEMPERATURE PROFILE**

One Time Reflow Soldering is Recommended.  
Do not immerse device body in solder paste.

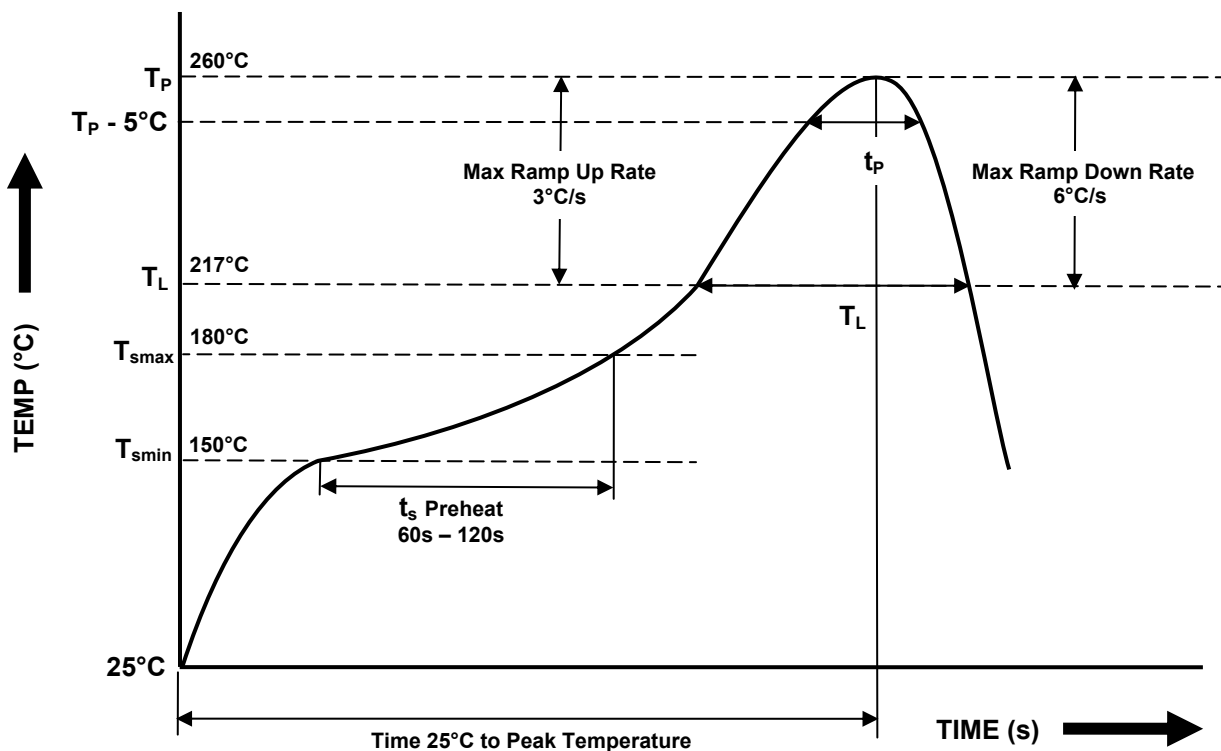

| Profile Details   | Conditions   |
|---|--|
| <b>Preheat</b><br>- Min Temperature (T <sub>Smin</sub> )<br>- Max Temperature (T <sub>Smax</sub> )<br>- Time T <sub>Smin</sub> to T <sub>Smax</sub> (t <sub>s</sub> )   | 150°C<br>180°C<br>60s - 120s                           |
| <b>Soldering Zone</b><br>- Peak Temperature (T <sub>P</sub> )<br>- Liquidous Temperature (T <sub>L</sub> )<br>- Time within 5°C of Actual Peak Temperature (T <sub>P</sub> - 5°C)<br>- Time maintained above T <sub>L</sub> (t <sub>L</sub> )<br>- Ramp Up Rate (T <sub>L</sub> to T <sub>P</sub> )<br>- Ramp Down Rate (T <sub>P</sub> to T <sub>L</sub> ) | 260°C<br>217°C<br>20s<br>60s<br>3°C/s max<br>3 - 6°C/s |
| Average Ramp Up Rate (T <sub>Smax</sub> to T <sub>P</sub> )   | 3°C/s max  |
| Time 25°C to Peak Temperature   | 8 minutes max  |



## DISCLAIMER

Isocom Components is continually working to improve the quality and reliability of its products. Nevertheless, semiconductor devices in general can malfunction or fail due to their inherent electrical sensitivity and vulnerability to physical stress. It is the responsibility of the buyer, when utilizing Isocom Components products, to comply with the standards of safety in making a safe design for the entire system, and to avoid situations in which a malfunction or failure of such Isocom Components products could cause loss of human life, bodily injury or damage to property.

In developing your designs, please ensure that Isocom Components products are used within specified operating ranges as set forth in the most recent Isocom Components products specifications.

The Isocom Components products listed in this document are intended for usage in general electronics applications (computer, personal equipment, office equipment, measuring equipment, industrial robotics, domestic appliances, etc.). These Isocom Components products are neither intended nor warranted for usage in equipment that requires extraordinarily high quality and/or reliability or a malfunction or failure of which may cause loss of human life or bodily injury ("Unintended Usage"). Unintended Usage include atomic energy control instruments, airplane or spaceship instruments, transportation Instruments, traffic signal instruments, combustion control instruments, medical Instruments, all types of safety devices, etc... Unintended Usage of Isocom Components products listed in this document shall be made at the customer's own risk.

Gallium arsenide (GaAs) is a substance used in the products described in this document. GaAs dust and fumes are toxic. Do not break, cut or pulverize the product, or use chemicals to dissolve them. When disposing of the products, follow the appropriate regulations. Do not dispose of the products with other industrial waste or with domestic garbage.

The products described in this document are subject to the foreign exchange and foreign trade laws.

The information contained herein is presented only as a guide for the applications of our products. No responsibility is assumed by Isocom Components for any infringements of intellectual property or other rights of the third parties which may result from its use. No license is granted by implication or otherwise under any intellectual property or other rights of Isocom Components or others.