

ISL23415

Single, Low Voltage Digitally Controlled Potentiometer (XDCP™)

FN7780
Rev.3.00
Mar 17, 2022

The **ISL23415** is a volatile, low voltage, low noise, low power, SPI™ bus, 256 taps, single digitally controlled potentiometer (DCP), which integrates DCP core, wiper switches and control logic on a monolithic CMOS integrated circuit.

The digitally controlled potentiometer is implemented with a combination of resistor elements and CMOS switches. The position of the wipers are controlled by the user through the SPI bus interface. The potentiometer has an associated volatile Wiper Register (WR) that can be directly written to and read by the user. The contents of the WR controls the position of the wiper. When powered on, the ISL23415's wiper will always commence at mid-scale (128 tap position).

The low voltage, low power consumption, and small package of the ISL23415 make it an ideal choice for use in battery operated equipment. In addition, the ISL23415 has a V_{LOGIC} pin allowing down to 1.2V bus operation, independent from the V_{CC} value. This allows for low logic levels to be connected directly to the ISL23415 without passing through a voltage level shifter.

The DCP can be used as a three-terminal potentiometer or as a two-terminal variable resistor in a wide variety of applications including control, parameter adjustments, and signal processing.

Features

- 256 resistor taps
- SPI serial interface
 - No additional level translator for low bus supply
 - Daisy Chaining of multiple DCP
- Power supply
 - V_{CC} = 1.7V to 5.5V analog power supply
 - V_{LOGIC} = 1.2V to 5.5V SPI bus/logic power supply
- Wiper resistance: 70Ω typical @ V_{CC} = 3.3V
- Shutdown Mode - forces the DCP into an end-to-end open circuit and RW is shorted to RL internally
- Power-on preset to mid-scale (128 tap position)
- Shutdown and standby current <2.8μA max
- DCP terminal voltage from 0V to V_{CC}
- 10kΩ or 100kΩ total resistance
- Extended industrial temperature range: -40 °C to +125 °C
- 10 Ld MSOP or 10 Ld μTQFN packages
- Pb-free (RoHS compliant)

Applications

- Power supply margining
- RF power amplifier bias compensation
- LCD bias compensation
- Gain adjustment in battery powered instruments
- Portable medical equipment calibration

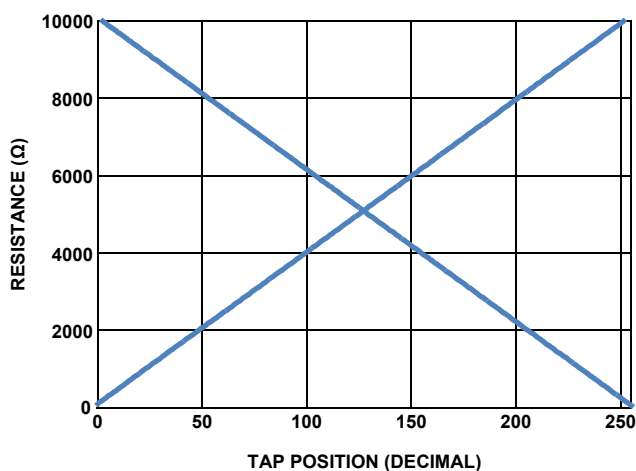

FIGURE 1. FORWARD AND BACKWARD RESISTANCE vs TAP POSITION, 10k

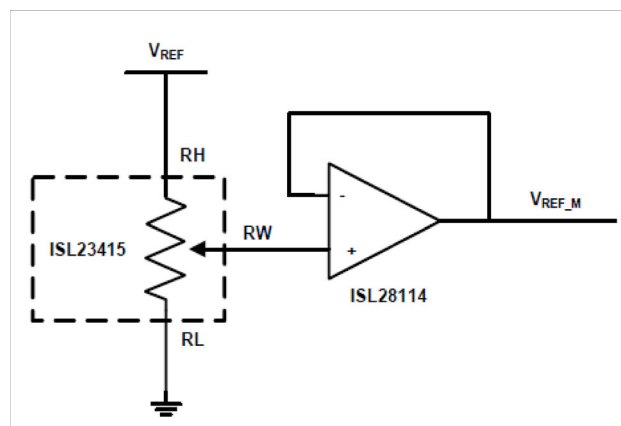
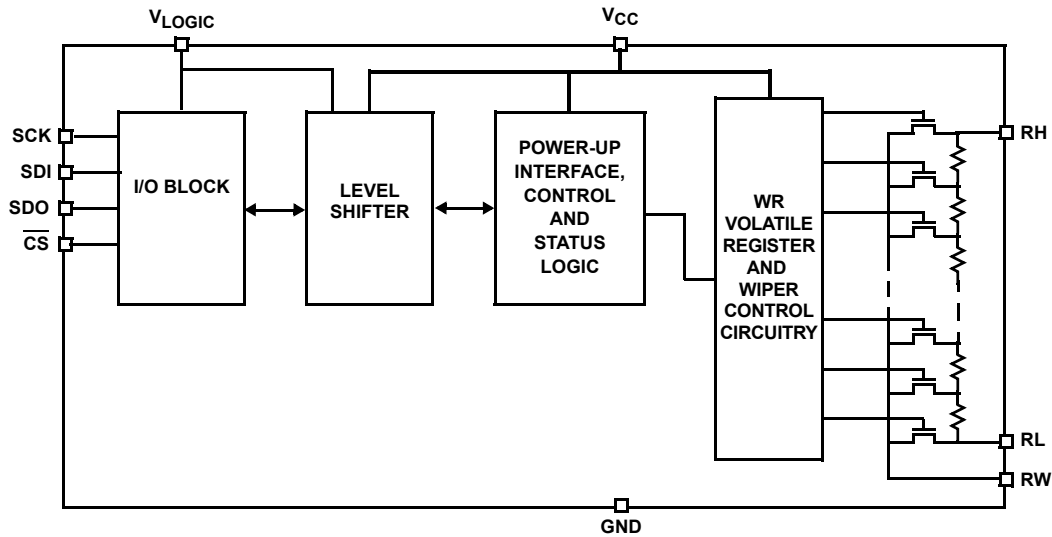
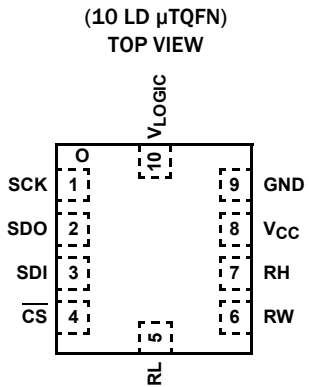
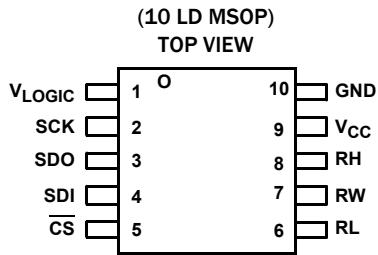

FIGURE 2. V_{REF} ADJUSTMENT

Block Diagram



Pin Configurations



Pin Descriptions

MSOP	μ TQFN	SYMBOL	DESCRIPTION
1	10	V _{LOGIC}	SPI bus/logic supply. Range 1.2V to 5.5V
2	1	SCK	Logic Pin - Serial bus clock input
3	2	SDO	Logic Pin - Serial bus data output (configurable)
4	3	SDI	Logic Pin - Serial bus data input
5	4	CS	Logic Pin - Active low Chip Select
6	5	RL	DCP "low" terminal
7	6	RW	DCP wiper terminal
8	7	RH	DCP "high" terminal
9	8	V _{CC}	Analog power supply. Range 1.7V to 5.5V
10	9	GND	Ground pin

Ordering Information

PART NUMBER (Note 4)	PART MARKING	RESISTANCE OPTION (k Ω)	PACKAGE DESCRIPTION (RoHS Compliant)	PKG. DWG. #	CARRIER TYPE (Note 1)	TEMP. RANGE
ISL23415TFUZ (Note 2)	3415T	100	10 Ld MSOP	M10.118	Tube	-40 to +125°C
ISL23415TFUZ-TK (Note 2)					Reel, 1k	
ISL23415TFUZ-T7A (Note 2)					Reel, 250	
ISL23415WUFUZ (Note 2)	3415W	10	10 Ld MSOP	M10.118	Tube	
ISL23415WUFUZ-TK (Note 2)					Reel, 1k	
ISL23415WUFUZ-T7A (Note 2)					Reel, 250	
ISL23415TFRUZ-T7A (Note 3)	HE	100	10 Ld μ TQFN 2.1x1.6	L10.2.1x1.6A	Reel, 250	
ISL23415TFRUZ-TK (Note 3)					Reel, 1k	

NOTES:

- See [TB347](#) for details about reel specifications.
- These Pb-free plastic packaged products employ special Pb-free material sets, molding compounds/die attach materials, and 100% matte tin plate plus anneal (e3 termination finish, which is RoHS compliant and compatible with both SnPb and Pb-free soldering operations). Pb-free products are MSL classified at Pb-free peak reflow temperatures that meet or exceed the Pb-free requirements of IPC/JEDEC J STD-020.
- These Pb-free plastic packaged products employ special Pb-free material sets; molding compounds/die attach materials and NiPdAu plate - e4 termination finish, which is RoHS compliant and compatible with both SnPb and Pb-free soldering operations. Pb-free products are MSL classified at Pb-free peak reflow temperatures that meet or exceed the Pb-free requirements of IPC/JEDEC J STD-020.
- For Moisture Sensitivity Level (MSL), see the [ISL23415](#) product information page. For more information about MSL please see [TB363](#).

Absolute Maximum Ratings

Supply Voltage Range	
V_{CC}	-0.3V to 6.0V
V_{LOGIC}	-0.3V to 6.0V
Voltage on any DCP Terminal Pin	-0.3V to 6.0V
Voltage on any Digital Pins	-0.3V to 6.0V
Wiper Current I_W (10s)	± 6 mA
ESD Rating	
Human Body Model (Tested per JESD22-A114E)	6.5kV
CDM Model (Tested per JESD22-A114E)	1kV
Machine Model (Tested per JESD22-A115-A)	200V
Latch Up	
(Tested per JESD-78B; Class 2, Level A)	100mA @ +125°C

Thermal Information

Thermal Resistance (Typical)	θ_{JA} (°C/W)	θ_{JC} (°C/W)
10 Ld MSOP Package (Note 5, 6)	170	70
10 Ld μ TQFN Package (Note 5, 6)	145	90
Maximum Junction Temperature (Plastic Package)	+150°C	
Storage Temperature Range	-65°C to +150°C	
Pb-Free Reflow Profile	see TB493	

Recommended Operating Conditions

Temperature	-40°C to +125°C
V_{CC} Supply Voltage	1.7V to 5.5V
V_{LOGIC} Supply Voltage	1.2V to 5.5V
DCP Terminal Voltage	0 to V_{CC}
Max Wiper Current	± 3 mA

CAUTION: Do not operate at or near the maximum ratings listed for extended periods of time. Exposure to such conditions may adversely impact product reliability and result in failures not covered by warranty.

NOTES:

- θ_{JA} is measured with the component mounted on a high effective thermal conductivity test board in free air. See [TB379](#) for details.
- For θ_{JC} , the case temperature location is the center top of the package.

Analog Specifications $V_{CC} = 2.7V$ to 5.5V, $V_{LOGIC} = 1.2V$ to 5.5V over recommended operating conditions unless otherwise stated. Boldface limits apply over the operating temperature range, -40°C to +125°C.

SYMBOL	PARAMETER	TEST CONDITIONS	MIN (Note 19)	TYP (Note 7)	MAX (Note 19)	UNITS
R_{TOTAL}	R_H to R_L Resistance	W option		10		k Ω
		T option		100		k Ω
	R_H to R_L Resistance Tolerance		-20	± 2	+20	%
	End-to-End Temperature Coefficient	W option			175	
T option				70		ppm/°C
V_{RH}, V_{RL}	DCP Terminal Voltage	V_{RH} or V_{RL} to GND	0		V_{CC}	V
R_W	Wiper Resistance	RH - floating, $V_{RL} = 0V$, force I_W current to the wiper, $I_W = (V_{CC} - V_{RL})/R_{TOTAL}$, $V_{CC} = 2.7V$ to 5.5V		70	200	Ω
		$V_{CC} = 1.7V$		580		Ω
$C_H/C_L/C_W$	Terminal Capacitance	See "DCP Macro Model" on page 7.		32		pF
I_{LkgDCP}	Leakage on DCP Pins	Voltage at pin from GND to V_{CC}	-0.4	<0.1	0.4	μA
Noise	Resistor Noise Density	Wiper at middle point, W option		16		nV/ \sqrt{Hz}
		Wiper at middle point, T option		61		nV/ \sqrt{Hz}
Feed Thru	Digital Feedthrough from Bus to Wiper	Wiper at middle point		-65		dB
PSRR	Power Supply Reject Ratio	Wiper output change if V_{CC} change $\pm 10\%$; wiper at middle point		-75		dB
VOLTAGE DIVIDER MODE (0V @ R_L; V_{CC} at R_H; measured at R_W, unloaded)						
INL (Note 12)	Integral Non-linearity, Guaranteed Monotonic	W option	-1.0	± 0.5	+1.0	LSB (Note 8)
		T option	-0.5	± 0.15	+0.5	LSB (Note 8)

Analog Specifications $V_{CC} = 2.7V$ to $5.5V$, $V_{LOGIC} = 1.2V$ to $5.5V$ over recommended operating conditions unless otherwise stated.
Boldface limits apply over the operating temperature range, $-40^{\circ}C$ to $+125^{\circ}C$. (Continued)

SYMBOL	PARAMETER	TEST CONDITIONS	MIN (Note 19)	TYP (Note 7)	MAX (Note 19)	UNITS
DNL (Note 11)	Differential Non-linearity, Guaranteed Monotonic	W option	-1	± 0.4	+1	LSB (Note 8)
		T option	-0.4	± 0.1	+0.4	LSB (Note 8)
FSerror (Note 10)	Full-scale Error	W option	-3.5	-2	0	LSB (Note 8)
		T option	-2	-0.5	0	LSB (Note 8)
ZSerror (Note 9)	Zero-scale Error	W option	0	2	3.5	LSB (Note 8)
		T option	0	0.4	2	LSB (Note 8)
TC _V (Note 13)	Ratiometric Temperature Coefficient	W option, Wiper Register set to 80 hex		8		ppm/ $^{\circ}C$
		T option, Wiper Register set to 80 hex		2.3		ppm/ $^{\circ}C$
	Large Signal Wiper Settling Time	From code 0 to FF hex		300		ns
f _{cutoff}	-3dB Cutoff Frequency	Wiper at middle point W option		1200		kHz
		Wiper at middle point T option		120		kHz
RHEOSTAT MODE (Measurements between RW and RL pins with RH not connected, or between RW and RH with RL not connected)						
RINL (Note 17)	Integral Non-linearity, Guaranteed Monotonic	W option; $V_{CC} = 2.7V$ to $5.5V$	-2.0	± 1	+2.0	MI (Note 14)
		W option; $V_{CC} = 1.7V$		10.5		MI (Note 14)
		T option; $V_{CC} = 2.7V$ to $5.5V$	-1.0	± 0.3	+1.0	MI (Note 14)
		T option; $V_{CC} = 1.7V$		2.1		MI (Note 14)
RDNL (Note 16)	Differential Non-linearity, Guaranteed Monotonic	W option; $V_{CC} = 2.7V$ to $5.5V$	-1	± 0.4	+1	MI (Note 14)
		W option; $V_{CC} = 1.7V$		± 0.6		MI (Note 14)
		T option; $V_{CC} = 2.7V$ to $5.5V$	-0.5	± 0.15	+0.5	MI (Note 14)
		T option; $V_{CC} = 1.7V$		± 0.35		MI (Note 14)
R _{offset} (Note 15)	Offset, Wiper at 0 Position	W option; $V_{CC} = 2.7V$ to $5.5V$	0	3	5.5	MI (Note 14)
		W option; $V_{CC} = 1.7V$		6.3		MI (Note 14)
		T option; $V_{CC} = 2.7V$ to $5.5V$	0	0.5	2	MI (Note 14)
		T option; $V_{CC} = 1.7V$		1.1		MI (Note 14)
TCR (Note 18)	Resistance Temperature Coefficient	W option; Wiper register set between 32 hex and FF hex		220		ppm/ $^{\circ}C$
		T option; Wiper register set between 32 hex and FF hex		75		ppm/ $^{\circ}C$

Operating Specifications

$V_{CC} = 2.7V$ to $5.5V$, $V_{LOGIC} = 1.2V$ to $5.5V$ over recommended operating conditions unless otherwise stated.
Boldface limits apply over the operating temperature range, $-40^{\circ}C$ to $+125^{\circ}C$.

SYMBOL	PARAMETER	TEST CONDITIONS	MIN (Note 19)	TYP (Note 7)	MAX (Note 19)	UNITS
I_{LOGIC}	V_{LOGIC} Supply Current (Write/Read)	$V_{LOGIC} = 5.5V$, $V_{CC} = 5.5V$, $f_{SCK} = 5MHz$ (for SPI active read and write)			1.5	mA
		$V_{LOGIC} = 1.2V$, $V_{CC} = 1.7V$, $f_{SCK} = 1MHz$ (for SPI active read and write)			30	μA
I_{CC}	V_{CC} Supply Current (Write/Read)	$V_{LOGIC} = 5.5V$, $V_{CC} = 5.5V$			100	μA
		$V_{LOGIC} = 1.2V$, $V_{CC} = 1.7V$			10	μA
$I_{LOGIC\ SB}$	V_{LOGIC} Standby Current	$V_{LOGIC} = 5.5V$, $V_{CC} = 5.5V$, SPI interface in standby			1.3	μA
		$V_{LOGIC} = 1.2V$, $V_{CC} = 1.7V$, SPI interface in standby			0.4	μA
$I_{CC\ SB}$	V_{CC} Standby Current	$V_{LOGIC} = 5.5V$, $V_{CC} = 5.5V$, SPI interface in standby			1.5	μA
		$V_{LOGIC} = 1.2V$, $V_{CC} = 1.7V$, SPI interface in standby			1	μA
$I_{LOGIC\ SHDN}$	V_{LOGIC} Shutdown Current	$V_{LOGIC} = 5.5V$, $V_{CC} = 5.5V$, SPI interface in standby			1.3	μA
		$V_{LOGIC} = 1.2V$, $V_{CC} = 1.7V$, SPI interface in standby			0.4	μA
$I_{CC\ SHDN}$	V_{CC} Shutdown Current	$V_{LOGIC} = V_{CC} = 5.5V$, SPI interface in standby			1.5	μA
		$V_{LOGIC} = 1.2V$, $V_{CC} = 1.7V$, SPI interface in standby			1	μA
I_{LkDig}	Leakage Current, at Pins \overline{CS} , SDO, SDI, SCK	Voltage at pin from GND to V_{LOGIC}	-0.4	<0.1	0.4	μA
t_{DCP}	Wiper Response Time	W option; \overline{CS} rising edge to wiper new position, from 10% to 90% of final value.		0.4		μs
		T option; \overline{CS} rising edge to wiper new position, from 10% to 90% of final value.		3.5		μs
$t_{ShdnRec}$	DCP Recall Time From Shutdown Mode	\overline{CS} rising edge to wiper recalled position and RH connection		1.5		μs
V_{CC}, V_{LOGIC} Ramp	V_{CC}, V_{LOGIC} Ramp Rate	Ramp monotonic at any level	0.01		50	V/ms

Serial Interface Specification

For SCK, SDI, SDO, \overline{CS} Unless Otherwise Noted.

SYMBOL	PARAMETER	TEST CONDITIONS	MIN (Note 19)	TYP (Note 7)	MAX (Note 19)	UNITS
V_{IL}	Input LOW Voltage		-0.3		$0.3 \times V_{LOGIC}$	V
V_{IH}	Input HIGH Voltage		$0.7 \times V_{LOGIC}$		$V_{LOGIC} + 0.3$	V
Hysteresis	SDI and SCK Input Buffer Hysteresis	$V_{LOGIC} > 2V$	$0.05 \times V_{LOGIC}$			V
		$V_{LOGIC} < 2V$	$0.1 \times V_{LOGIC}$			
V_{OL}	SDO Output Buffer LOW Voltage	$I_{OL} = 3mA$, $V_{LOGIC} > 2V$	0		0.4	V
		$I_{OL} = 1.5mA$, $V_{LOGIC} < 2V$			$0.2 \times V_{LOGIC}$	V
R_{pu} (Note 18)	SDO Pull-up Resistor Off-chip	Maximum is determined by t_{R0} and t_{F0} with maximum bus load $C_b = 30pF$, $f_{SCK} = 5MHz$			1.5	$k\Omega$
C_{pin}	SCK, SDO, SDI, \overline{CS} Pin Capacitance			10		pF

Serial Interface Specification For SCK, SDI, SDO, $\overline{\text{CS}}$ Unless Otherwise Noted. (Continued)

SYMBOL	PARAMETER	TEST CONDITIONS	MIN (Note 19)	TYP (Note 7)	MAX (Note 19)	UNITS
f_{SCK}	SCK Frequency	$V_{\text{LOGIC}} = 1.7\text{V to } 5.5\text{V}$			5	MHz
		$V_{\text{LOGIC}} = 1.2\text{V to } 1.6\text{V}$			1	MHz
t_{CYC}	SPI Clock Cycle Time	$V_{\text{LOGIC}} \geq 1.7\text{V}$	200			ns
t_{WH}	SPI Clock High Time	$V_{\text{LOGIC}} \geq 1.7\text{V}$	100			ns
t_{WL}	SPI Clock Low Time	$V_{\text{LOGIC}} \geq 1.7\text{V}$	100			ns
t_{LEAD}	Lead Time	$V_{\text{LOGIC}} \geq 1.7\text{V}$	250			ns
t_{LAG}	Lag Time	$V_{\text{LOGIC}} \geq 1.7\text{V}$	250			ns
t_{SU}	SDI, SCK and $\overline{\text{CS}}$ Input Setup Time	$V_{\text{LOGIC}} \geq 1.7\text{V}$	50			ns
t_{H}	SDI, SCK and $\overline{\text{CS}}$ Input Hold Time	$V_{\text{LOGIC}} \geq 1.7\text{V}$	50			ns
t_{RI}	SDI, SCK and $\overline{\text{CS}}$ Input Rise Time	$V_{\text{LOGIC}} \geq 1.7\text{V}$	10			ns
t_{FI}	SDI, SCK and $\overline{\text{CS}}$ Input Fall Time	$V_{\text{LOGIC}} \geq 1.7\text{V}$	10		20	ns
t_{DIS}	SDO Output Disable Time	$V_{\text{LOGIC}} \geq 1.7\text{V}$	0		100	ns
t_{SO}	SDO Output Setup Time	$V_{\text{LOGIC}} \geq 1.7\text{V}$	50			ns
t_{V}	SDO Output Valid Time	$V_{\text{LOGIC}} \geq 1.7\text{V}$	150			ns
t_{HO}	SDO Output Hold Time	$V_{\text{LOGIC}} \geq 1.7\text{V}$	0			ns
t_{RO}	SDO Output Rise Time	$R_{\text{pu}} = 1.5\text{k}, C_{\text{bus}} = 30\text{pF}$			60	ns
t_{FO}	SDO Output Fall Time	$R_{\text{pu}} = 1.5\text{k}, C_{\text{bus}} = 30\text{pF}$			60	ns
t_{CS}	$\overline{\text{CS}}$ Deselect Time		2			μs

NOTES:

- Typical values are for $T_A = +25^\circ\text{C}$ and 3.3V supply voltages.
- $\text{LSB} = [V(\text{RW})_{255} - V(\text{RW})_0]/255$. $V(\text{RW})_{255}$ and $V(\text{RW})_0$ are $V(\text{RW})$ for the DCP register set to FF hex and 00 hex respectively. LSB is the incremental voltage when changing from one tap to an adjacent tap.
- $\text{ZS error} = V(\text{RW})_0/\text{LSB}$.
- $\text{FS error} = [V(\text{RW})_{255} - V_{\text{CC}}]/\text{LSB}$.
- $\text{DNL} = [V(\text{RW})_i - V(\text{RW})_{i-1}]/\text{LSB} - 1$, for $i = 1$ to 255. i is the DCP register setting.
- $\text{INL} = [V(\text{RW})_i - i \cdot \text{LSB} - V(\text{RW})_0]/\text{LSB}$ for $i = 1$ to 255
- $C_V = \frac{\text{Max}(V(\text{RW})_i) - \text{Min}(V(\text{RW})_i)}{V(\text{RW})_i(+25^\circ\text{C})} \times \frac{10^6}{+165^\circ\text{C}}$ for $i = 16$ to 255 decimal, $T = -40^\circ\text{C}$ to $+125^\circ\text{C}$. $\text{Max}()$ is the maximum value of the wiper voltage and $\text{Min}()$ is the minimum value of the wiper voltage over the temperature range.
- $\text{MI} = |RW_{255} - RW_0|/255$. MI is a minimum increment. RW_{255} and RW_0 are the measured resistances for the DCP register set to FF hex and 00 hex respectively.
- $\text{Roffset} = RW_0/\text{MI}$, when measuring between RW and RL.
 $\text{Roffset} = RW_{255}/\text{MI}$, when measuring between RW and RH.
- $\text{RDNL} = (RW_i - RW_{i-1})/\text{MI} - 1$, for $i = 16$ to 255.
- $\text{RINL} = [RW_i - (\text{MI} \cdot i) - RW_0]/\text{MI}$, for $i = 16$ to 255.
- $C_R = \frac{[\text{Max}(R_i) - \text{Min}(R_i)]}{R_i(+25^\circ\text{C})} \times \frac{10^6}{+165^\circ\text{C}}$ for $i = 16$ to 255, $T = -40^\circ\text{C}$ to $+125^\circ\text{C}$. $\text{Max}()$ is the maximum value of the resistance and $\text{Min}()$ is the minimum value of the resistance over the temperature range.
- Compliance to datasheet limits is assured by one or more methods: production test, characterization and/or design.

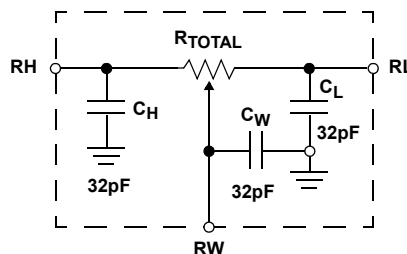
DCP Macro Model

Timing Diagrams

Input Timing

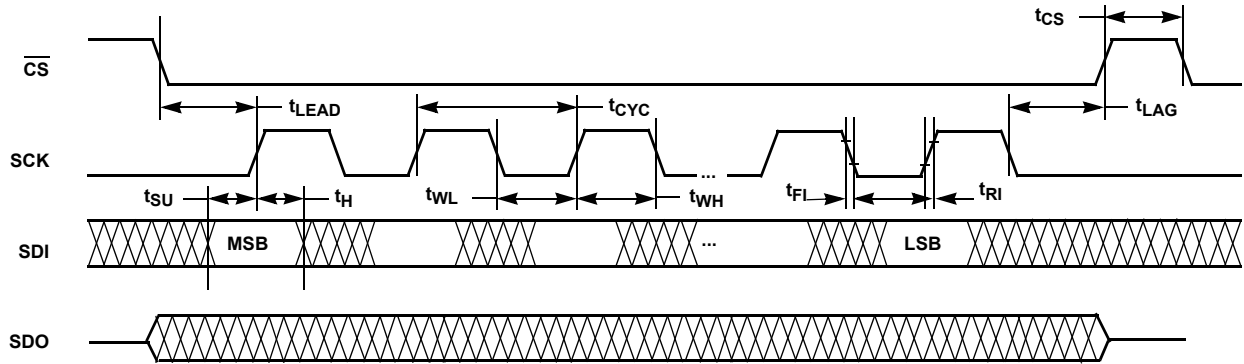

Output Timing

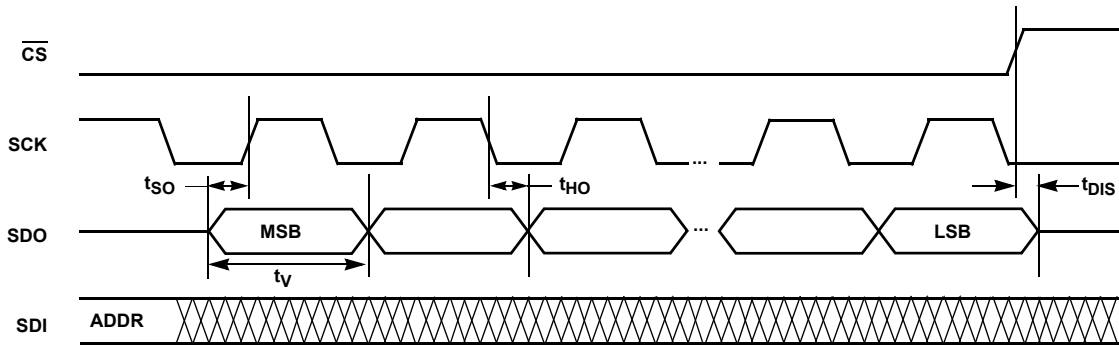

XDCP™ Timing (for All Load Instructions)

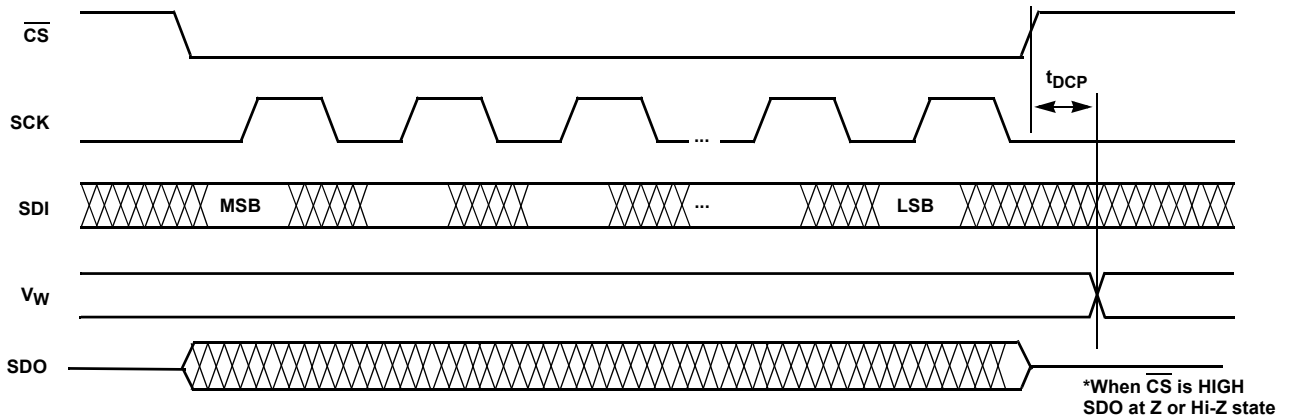

Typical Performance Curves

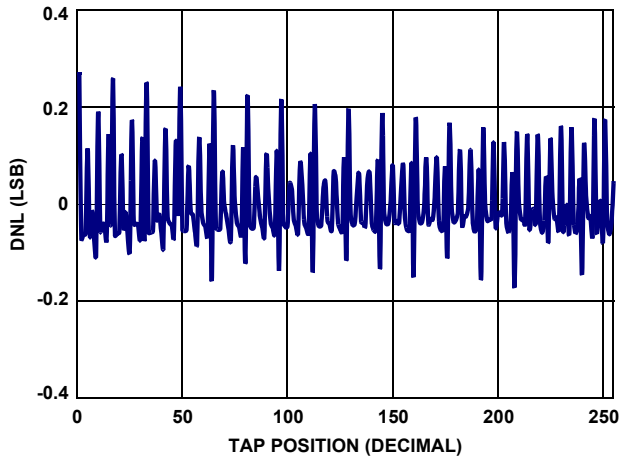

FIGURE 3. 10k DNL vs TAP POSITION, $V_{CC} = 5V$

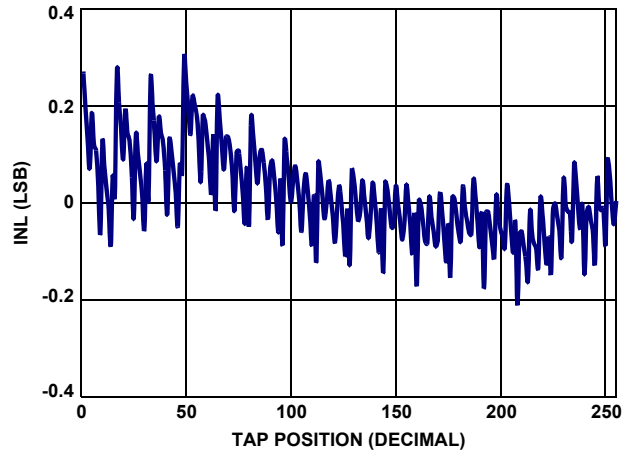

FIGURE 4. 10k INL vs TAP POSITION, $V_{CC} = 5V$

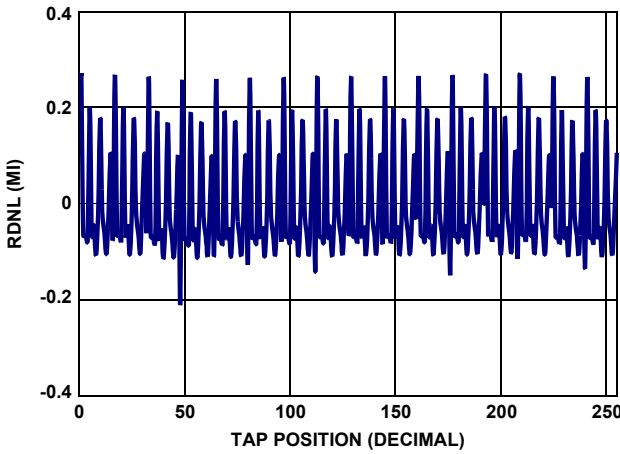

FIGURE 5. 10k RDNL vs TAP POSITION, $V_{CC} = 5V$

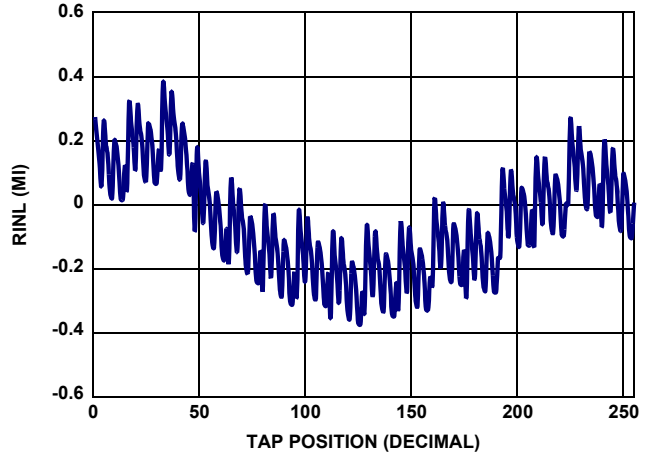

FIGURE 6. 10k RINL vs TAP POSITION, $V_{CC} = 5V$

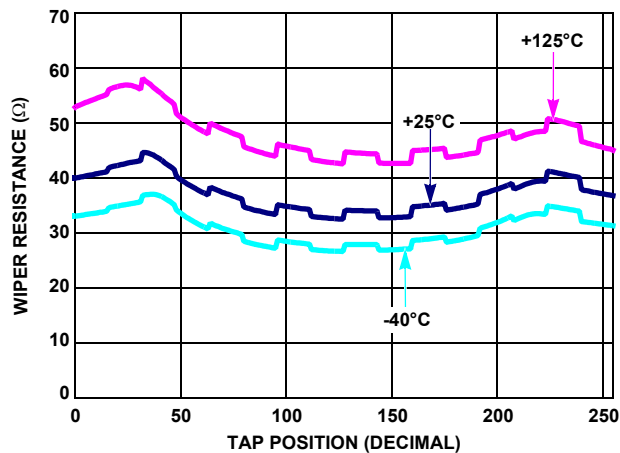

FIGURE 7. 10k WIPER RESISTANCE vs TAP POSITION, $V_{CC} = 5V$

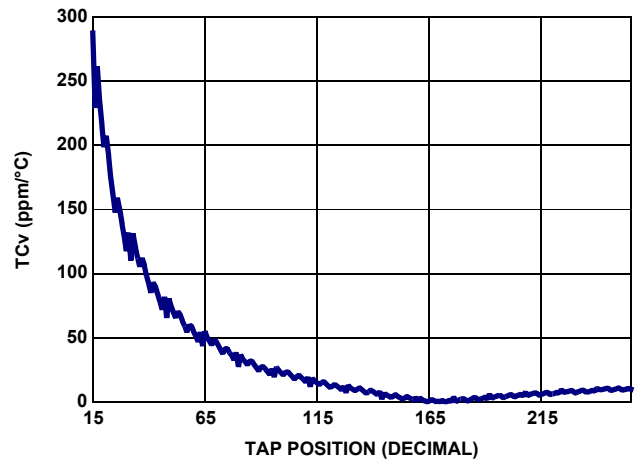

FIGURE 8. 10k TCv vs TAP POSITION

Typical Performance Curves (Continued)

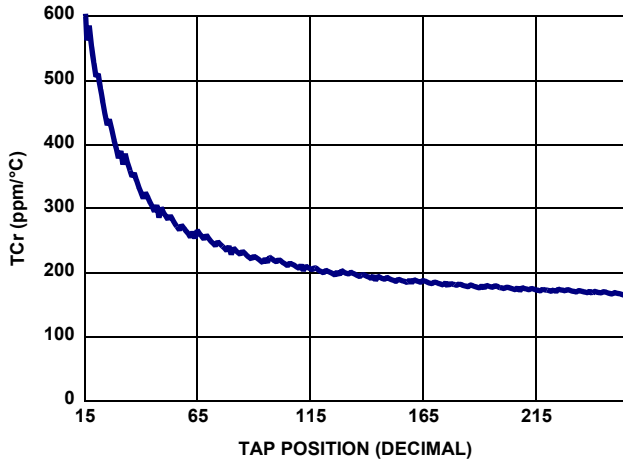

FIGURE 9. 10k TCr vs TAP POSITION

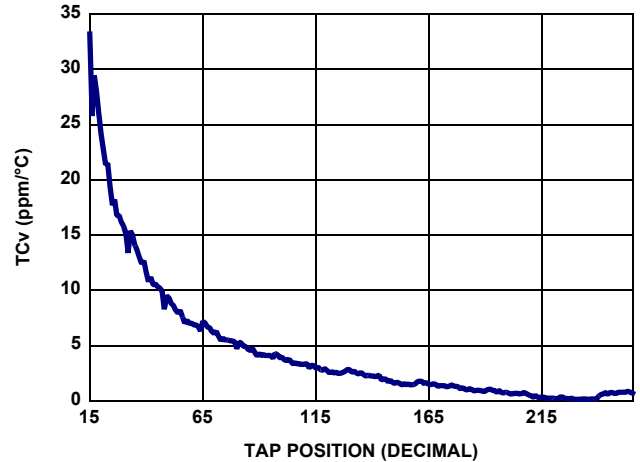

FIGURE 10. 100k TCv vs TAP POSITION

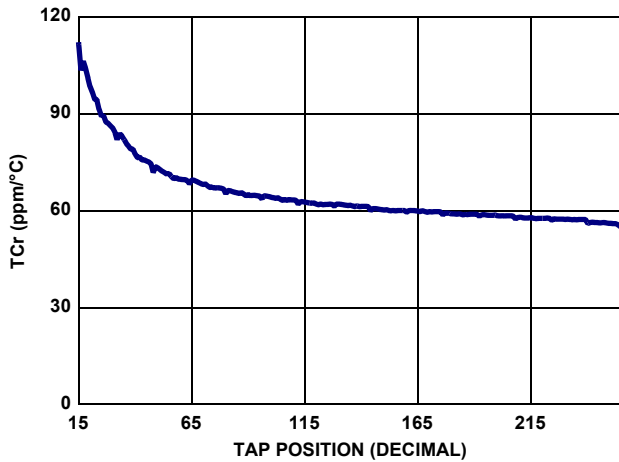

FIGURE 11. 100k TCr vs TAP POSITION

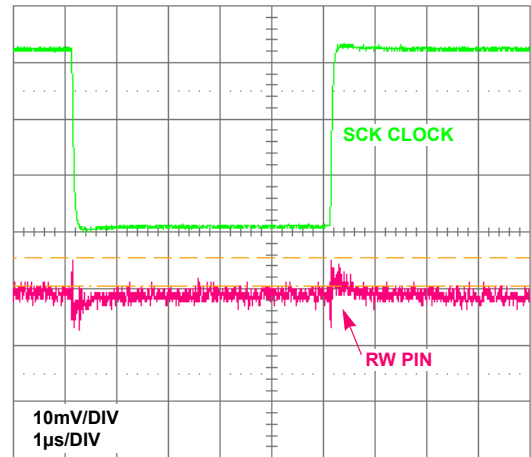

FIGURE 12. WIPER DIGITAL FEEDTHROUGH

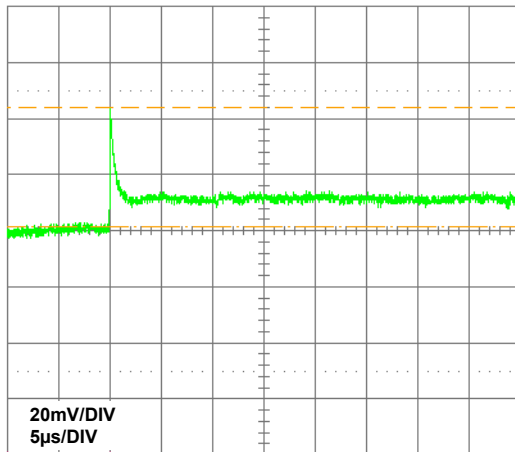

FIGURE 13. WIPER TRANSITION GLITCH

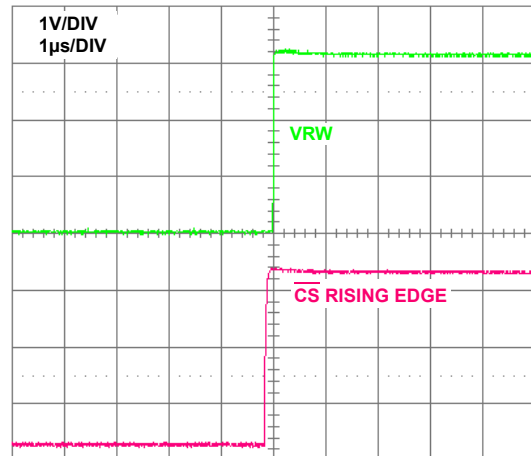

FIGURE 14. WIPER LARGE SIGNAL SETTLING TIME

Typical Performance Curves (Continued)

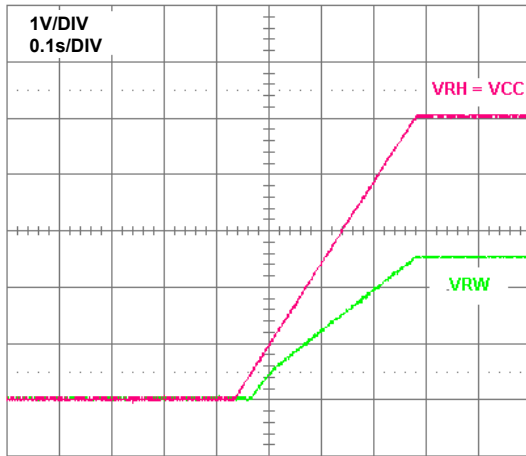

FIGURE 15. POWER-ON START-UP IN VOLTAGE DIVIDER MODE

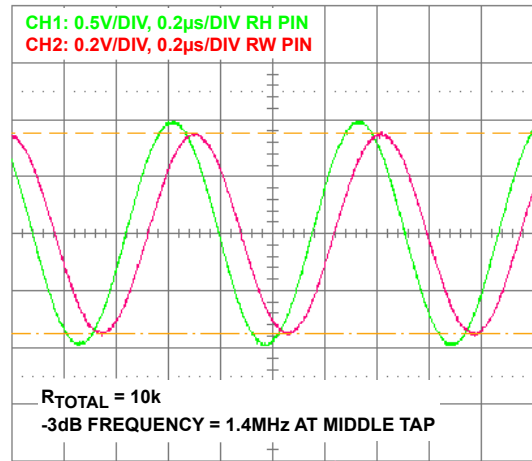

FIGURE 16. 10k -3dB CUT OFF FREQUENCY

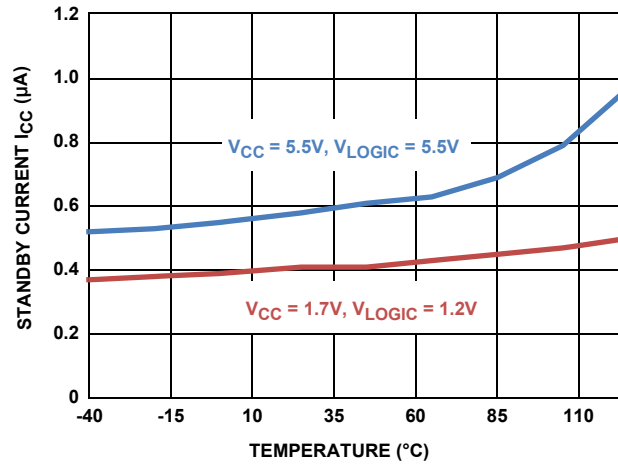

FIGURE 17. STANDBY CURRENT vs TEMPERATURE

Functional Pin Description

Potentiometers Pins

RH AND RL

The high (RH) and low (RL) terminals of the ISL23415 are equivalent to the fixed terminals of a mechanical potentiometer. The RH and RL are referenced to the relative position of the wiper and not the voltage potential on the terminals. With the WR register set to 255 decimal, the wiper will be closest to RH, and with the WR register set to 0, the wiper is closest to RL.

RW

The RW is the wiper terminal, and it is equivalent to the moveable terminal of a mechanical potentiometer. The position of the wiper within the array is determined by the WR register.

Power Pins

V_{CC}

Power terminal for the potentiometer section analog power source. Can be any value needed to support voltage range of DCP pins, from 1.7V to 5.5V, independent of the V_{LOGIC} voltage.

Bus Interface Pins

SERIAL CLOCK (SCL)

This input is the serial clock of the SPI serial interface.

SERIAL DATA INPUT (SDI)

The SDI is a serial data input pin for SPI interface. It receives operation code, wiper address and data from the SPI remote host device. The data bits are shifted in at the rising edge of the serial clock SCK, while the CS input is low.

SERIAL DATA OUTPUT (SDO)

The SDO is a serial data output pin. During a read cycle, the data bits are shifted out on the falling edge of the serial clock SCK and will be available to the master on the following rising edge of SCK.

The output type is configured through ACR[1] bit for Push-Pull or Open Drain operation. Default setting for this pin is Push-Pull. An external pull-up resistor is required for Open Drain output operation. When CS is HIGH, the SDO pin is in tri-state (Z) or high-tri-state (Hi-Z) depends on the selected configuration.

CHIP SELECT ($\overline{\text{CS}}$)

$\overline{\text{CS}}$ LOW enables the ISL23415, placing it in the active power mode. A HIGH to LOW transition on $\overline{\text{CS}}$ is required prior to the start of any operation after power-up. When $\overline{\text{CS}}$ is HIGH, the ISL23415 is deselected and the SDO pin is at high impedance, and the device will be in the standby state.

V_{LOGIC}

Digital power source for the logic control section. It supplies an internal level translator for 1.2V to 5.5V serial bus operation. Use the same supply as the I²C logic source.

Principles of Operation

The ISL23415 is an integrated circuit incorporating one DCP with its associated registers and an SPI serial interface providing direct communication between a host and the potentiometer. The resistor array is comprised of individual resistors connected in series. At either end of the array and between each resistor is an electronic switch that transfers the potential at that point to the wiper.

The electronic switches on the device operate in a “make before break” mode when the wiper changes tap positions.

Voltage at any DCP pins, RH, RL or RW, should not exceed V_{CC} level at any conditions during power-up and normal operation.

The V_{LOGIC} pin needs to be connected to the SPI bus supply which allows reliable communication with the wide range of microcontrollers and independent of the V_{CC} level. This is extremely important in systems where the digital supply has lower levels than the analog supply.

DCP Description

Each DCP is implemented with a combination of resistor elements and CMOS switches. The physical ends of DCP are equivalent to the fixed terminals of a mechanical potentiometer (RH and RL pins). The RW pin of the DCP is connected to intermediate nodes, and is equivalent to the wiper terminal of a mechanical potentiometer. The position of the wiper terminal within the DCP is controlled by the 8-bit volatile Wiper Register (WR). When the WR of a DCP contains all zeroes (WR[7:0] = 00h), its wiper terminal (RW) is closest to its “Low” terminal (RL). When the WR register of a DCP contains all ones (WR[7:0] = FFh), its wiper terminal (RW) is closest to its “High” terminal (RH). As the value of the WR increases from all zeroes (0) to all ones (255 decimal), the wiper moves monotonically from the position closest to RL to the position closest to RH. At the same time, the resistance between RW and RL increases monotonically, while the resistance between RH and RW decreases monotonically.

While the ISL23415 is being powered up, the WR is reset to 80h (128 decimal), which locates RW roughly at the center between RL and RH.

The WR can be read or written to directly using the SPI serial interface as described in the following sections.

Memory Description

The ISL23415 contains two volatile 8-bit registers: the Wiper Register (WR) and the Access Control Register (ACR). Memory map of ISL23415 is in Table 1. The Wiper Register WR at address 0 contains current wiper position of the DCP. The Access Control Register (ACR) at address 10h contains information and control bits described in Table 2.

TABLE 1. MEMORY MAP

ADDRESS (hex)	VOLATILE	DEFAULT SETTING (hex)
10	ACR	40
0	WR	80

TABLE 2. ACCESS CONTROL REGISTER (ACR)

BIT #	7	6	5	4	3	2	1	0
NAME	0	SHDN	0	0	0	0	SDO	0

The SDO bit (ACR[1]) configures type of SDO output pin. The default value of SDO bit is 0 for Push-Pull output. The SDO pin can be configured as Open Drain output for some applications. In this case, an external pull-up resistor is required, reference the “Serial Interface Specification” on page 6.

Shutdown Function

The SHDN bit (ACR[6]) disables or enables shutdown mode for all DCP channels simultaneously. When this bit is 0, i.e., each DCP is forced to end-to-end open circuit and each RW shorted to RL through a 2kΩ serial resistor, as shown in Figure 18. Default value of the SHDN bit is 1.

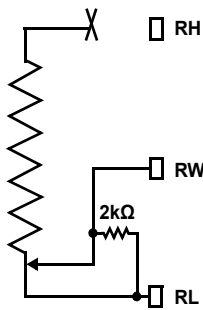

FIGURE 18. DCP CONNECTION IN SHUTDOWN MODE

When the device enters shutdown, all current DCP WR settings are maintained. When the device exits shutdown, the wipers will

return to the previous WR settings after a short settling time (see Figure 26).

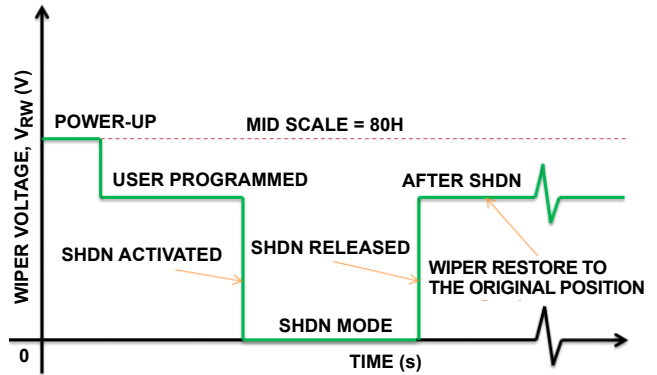

FIGURE 19. SHUTDOWN MODE WIPER RESPONSE

SPI Serial Interface

The ISL23415 supports an SPI serial protocol, mode 0. The device is accessed via the SDI input and SDO output with data clocked in on the rising edge of SCK, and clocked out on the falling edge of SCK. CS must be LOW during communication with the ISL23415. The SCK and CS lines are controlled by the host or master. The ISL23415 operates only as a slave device.

All communication over the SPI interface is conducted by sending the MSB of each byte of data first.

Protocol Conventions

The SPI protocol contains Instruction Byte followed by one or more Data Bytes. A valid Instruction Byte contains instruction as the three MSBs, with the following five register address bits (see Table 3).

The next byte sent to the ISL23415 is the Data Byte.

TABLE 3. INSTRUCTION BYTE FORMAT

BIT #	7	6	5	4	3	2	1	0
	I2	I1	I0	R4	R3	R2	R1	R0

Table 4 contains a valid instruction set for ISL23415.

If the [R4:R0] bits are zero or one, then the read or write is to the WRi register. If the [R4:R0] are 10000, then the operation is to the ACR.

TABLE 4. INSTRUCTION SET

INSTRUCTION SET								OPERATION
I2	I1	I0	R4	R3	R2	R1	R0	
0	0	0	X	X	X	X	X	NOP
0	0	1	X	X	X	X	X	ACR READ
0	1	1	X	X	X	X	X	ACR WRTE
1	0	0	R4	R3	R2	R1	R0	WRi or ACR READ
1	1	0	R4	R3	R2	R1	R0	WRi or ACR WRTE

Where X means “do not care”.

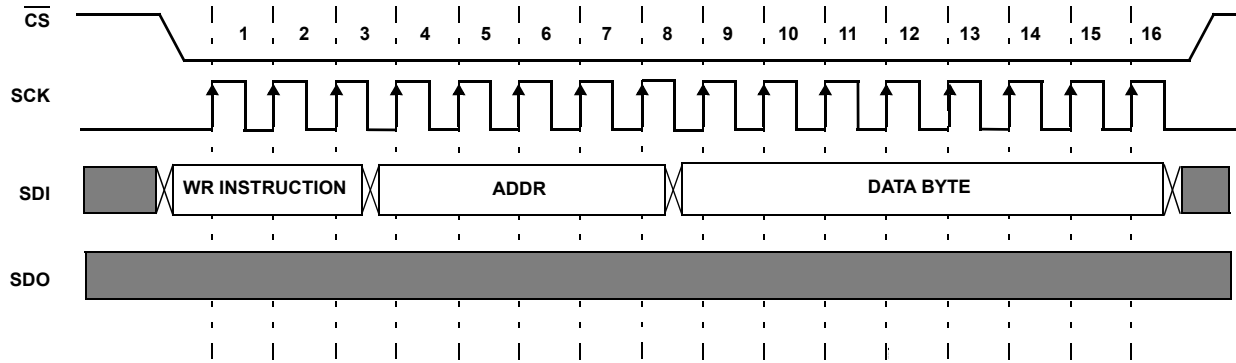

FIGURE 20. TWO BYTE WRITE SEQUENCE

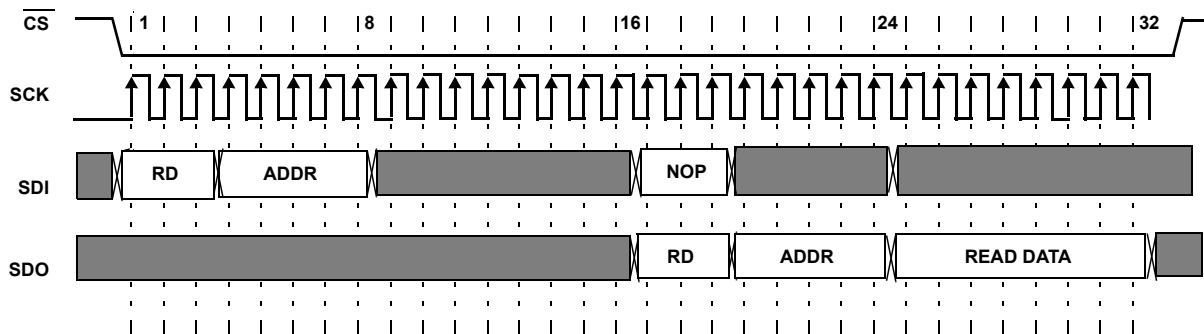

FIGURE 21. FOUR BYTE READ SEQUENCE

Write Operation

A write operation to the ISL23415 is a two or more bytes operation. It requires first, the \overline{CS} transition from HIGH-to-LOW. Then the host sends a valid Instruction Byte, followed by one or more Data Bytes to the SDI pin. The host terminates the write operation by pulling the \overline{CS} pin from LOW-to-HIGH. Instruction is executed on the rising edge of \overline{CS} (see Figure 20).

Read Operation

A Read operation to the ISL23415 is a four byte operation. It requires first, the \overline{CS} transition from HIGH-to-LOW. Then the host sends a valid Instruction Byte, followed by a “dummy” Data Byte, NOP Instruction Byte and another “dummy” Data Byte to SDI pin. The SPI host receives the Instruction Byte (instruction code + register address) and requested Data Byte from SDO pin on the rising edge of SCK during third and fourth bytes, respectively. The host terminates the read by pulling the \overline{CS} pin from LOW-to-HIGH (see Figure 21).

Applications Information

Communicating with ISL23415

Communication with ISL23415 proceeds using SPI interface through the ACR (address 10000b) and WR (addresses 00000b) registers.

The wiper of the potentiometer is controlled by the WR register. Writes and reads can be made directly to these register to control and monitor the wiper position.

Daisy Chain Configuration

When application needs more than one ISL23415, it can communicate with all of them without additional \overline{CS} lines by daisy chaining the DCPs as shown on Figure 22. In Daisy Chain configuration, the SDO pin of the previous chip is connected to the SDI pin of the following chip, and each \overline{CS} and SCK pins are connected to the corresponding microcontroller pins in parallel, like regular SPI interface implementation. The Daisy Chain configuration can also be used for simultaneous setting of multiple DCPs. Note, the number of daisy chained DCPs is limited only by the driving capabilities of SCK and \overline{CS} pins of microcontroller; for larger number of SPI devices buffering of SCK and \overline{CS} lines is required.

Daisy Chain Write Operation

The write operation starts by HIGH-to-LOW transition on \overline{CS} line, followed by N number of two bytes write instructions on SDI line with reversed chain access sequence: the instruction byte + data byte for the last DCP in chain is going first, as shown in Figure 23, where N is a number of DCPs in chain. The serial data is going through DCPs from DCP0 to DCP(N-1) as follow: DCP0 → DCP1 → DCP2 → ... → DCP(N-1). The write instruction is executed on the rising edge of \overline{CS} for all N DCPs simultaneously.

Daisy Chain Read Operation

The read operation consists of two parts: first, send the read instructions (N two bytes operation) with valid address; second, read the requested data while sending NOP instructions (N two bytes operation) as shown in Figures 24 and 25.

The first part starts by HIGH-to-LOW transition on \overline{CS} line, followed by N two bytes read instruction on SDI line with reversed chain access sequence: the instruction byte + dummy data byte for the last DCP in chain is going first, followed by LOW-to-HIGH transition on \overline{CS} line. The read instructions are executed during second part of read sequence. It also starts by HIGH-to-LOW transition on \overline{CS} line, followed by N number of two bytes NOP instructions on SDI line and LOW-to-HIGH transition of \overline{CS} . The data is read on every even byte during second part of read sequence while every odd byte contains code 111b followed by address from which the data is being read.

Wiper Transition

When stepping up through each tap in voltage divider mode, some tap transition points can result in noticeable voltage transients, or overshoot/undershoot, resulting from the sudden transition from a very low impedance “make” to a much higher impedance “break within a short period of time (<1μs). There are

several code transitions such as 0Fh to 10h, 1Fh to 20h, ..., EFh to FFh, which have higher transient glitch. Note, that all switching transients will settle well within the settling time as stated in the datasheet. A small capacitor can be added externally to reduce the amplitude of these voltage transients, but that will also reduce the useful bandwidth of the circuit, thus may not be a good solution for some applications. It may be a good idea, in that case, to use fast amplifiers in a signal chain for fast recovery.

V_{LOGIC} Requirements

It is recommended to keep V_{LOGIC} powered all the time during normal operation. In a case where turning V_{LOGIC} OFF is necessary, it is recommended to ground the V_{LOGIC} pin of the ISL23415. Grounding the V_{LOGIC} pin or both V_{LOGIC} and V_{CC} does not affect other devices on the same bus. It is good practice to put a 1μF capacitor in parallel with 0.1μF decoupling capacitor close to the V_{LOGIC} pin.

V_{CC} Requirements and Placement

It is recommended to put a 1μF capacitor in parallel with 0.1μF decoupling capacitor close to the V_{CC} pin.

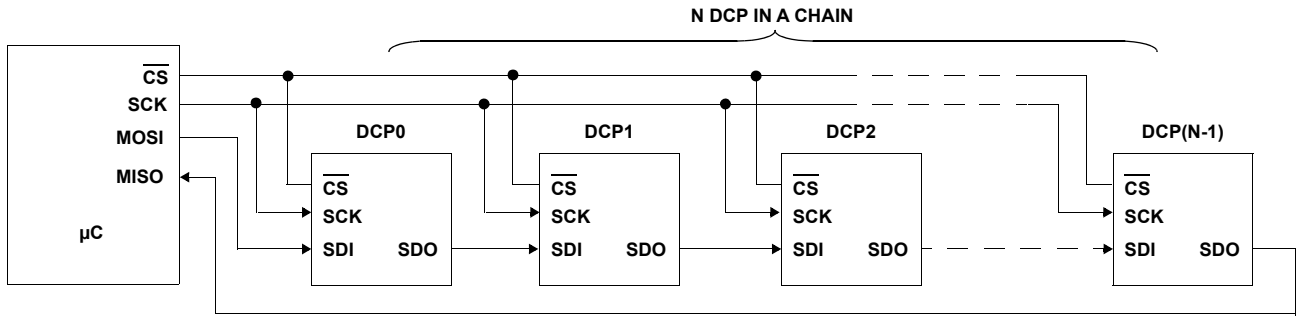

FIGURE 22. DAISY CHAIN CONFIGURATION

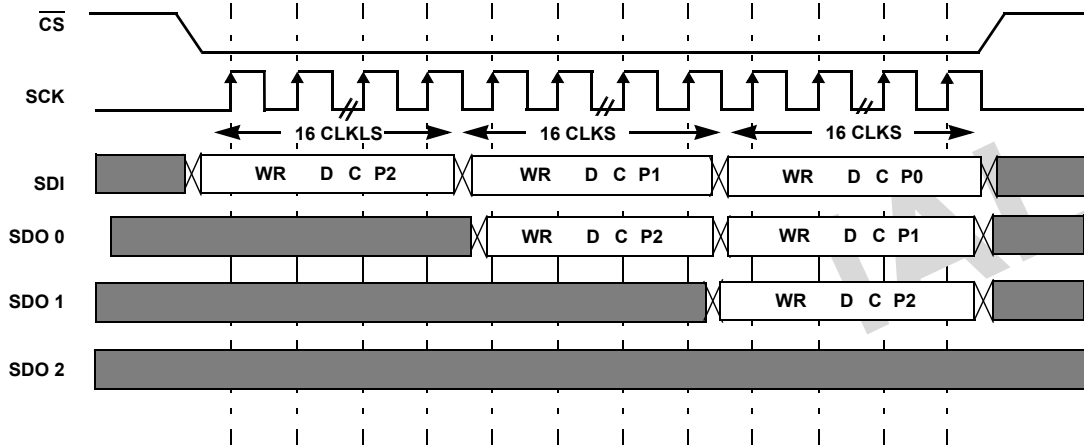

FIGURE 23. DAISY CHAIN WRITE SEQUENCE OF N = 3 DCP

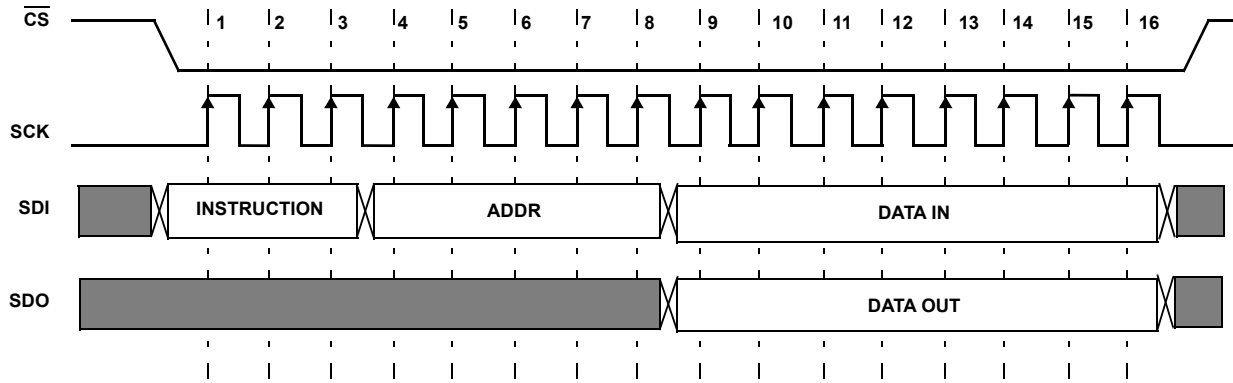

FIGURE 24. TWO BYTE READ INSTRUCTION

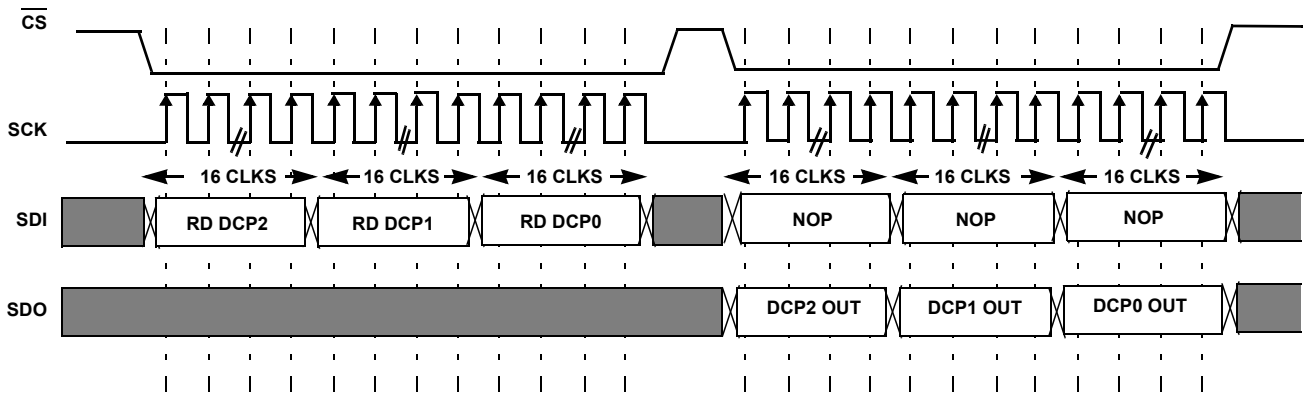

FIGURE 25. DAISY CHAIN READ SEQUENCE OF N = 3 DCP

Revision History

The revision history provided is for informational purposes only and is believed to be accurate, but not warranted. Please go to web to make sure you have the latest Rev

DATE	REVISION	CHANGE
Mar 17, 2022	3.00	Removed About Intersil section. Removed 50k Ω option information throughout datasheet. Updated the Ordering Information table formatting. Updated POD M10.118 to the latest revision, changes are as follows: -Corrected typo in the side view 1 updating package thickness tolerance from ± 0.10 to ± 0.10 .
Sep 14, 2015	2.00	Updated Ordering Information on page 3. Updated Products to About Intersil Verbiage. Updated POD M10.118 to most current revision. Revision change is as follows: Updated to new POD template. Added land pattern
Jul 28, 2011	1.00	Added "Shutdown Function" section and revised " V_{LOGIC} Standby Current" and " V_{CC} Shutdown Current" limits on page 6. On page 6, split "Wiper Response Time" up into 3 separate conditions for each option (W, U, T).
Dec 15, 2010	0.00	Initial Release.

Package Outline Drawings

For the most recent package outline drawing, see [M10.118](#).

M10.118

10 Lead Mini Small Outline Plastic Package

Rev 2, 5/2021

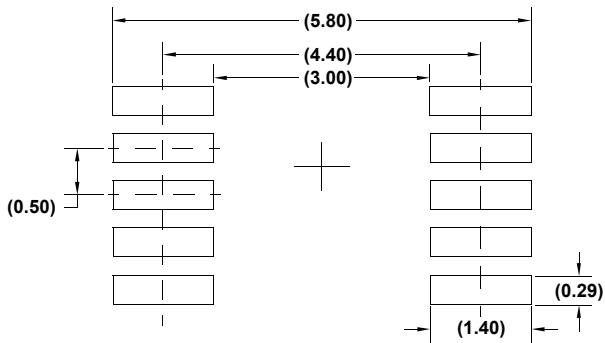
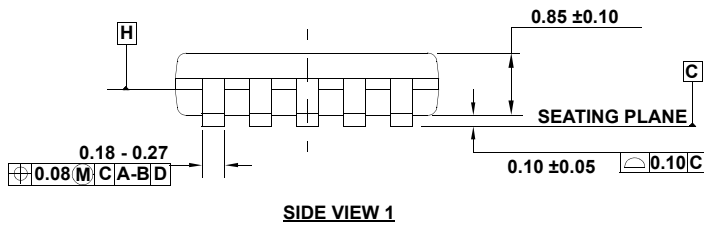
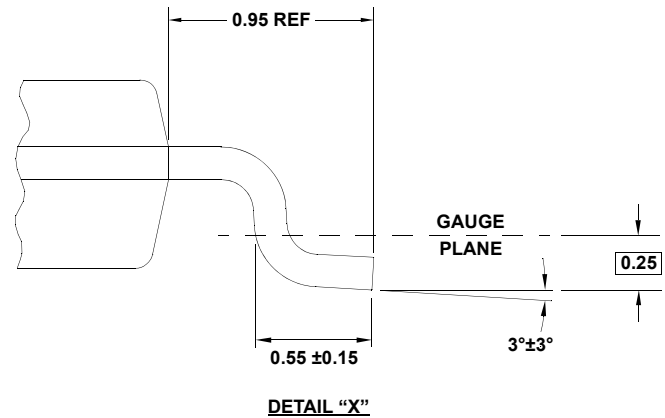
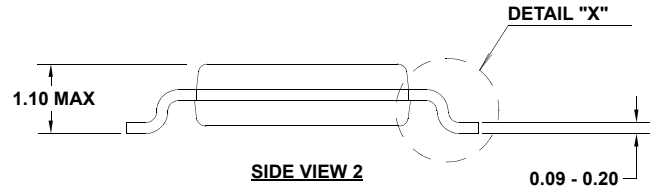
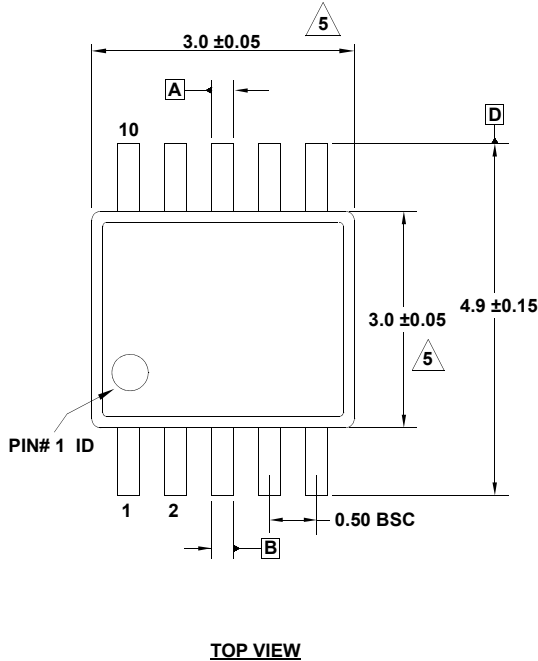

NOTES:

1. Dimensions are in millimeters.
2. Dimensioning and tolerancing conform to JEDEC MO-187-BA and AMSEY14.5m-1994.
3. Plastic or metal protrusions of 0.15mm max per side are not included.
4. Plastic interlead protrusions of 0.15mm max per side are not included.
5. Dimensions are measured at Datum Plane "H".
6. Dimensions in () are for reference only.

For the most recent package outline drawing, see [L10.2.1x1.6A](#).

L10.2.1x1.6A

10 Lead Ultra Thin Quad Flat No-Lead Plastic Package

Rev 5, 3/10

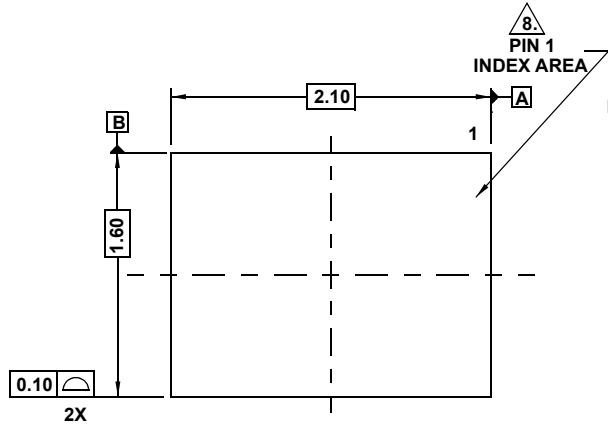

TOP VIEW

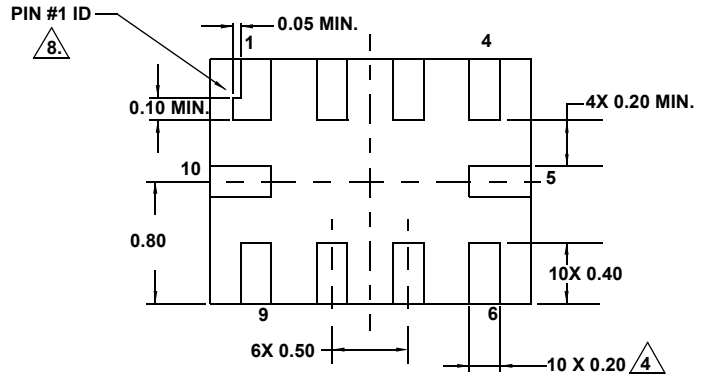

BOTTOM VIEW

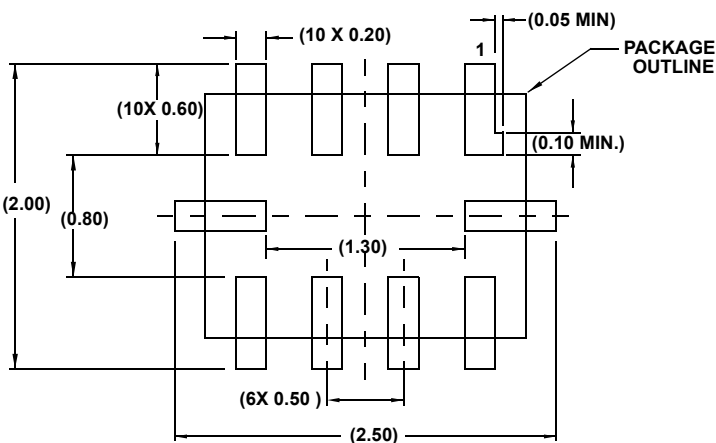
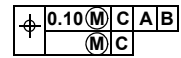

TYPICAL RECOMMENDED LAND PATTERN

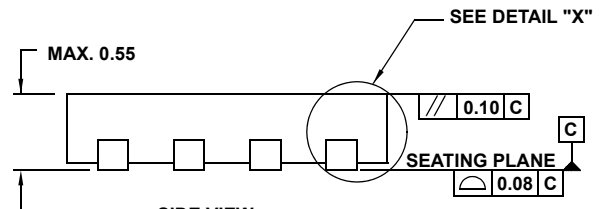

SIDE VIEW

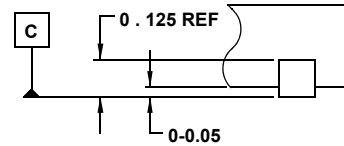

DETAIL "X"

NOTES:

1. Dimensioning and tolerancing conform to ASME Y14.5M-1994.
2. All Dimensions are in millimeters. Angles are in degrees. Dimensions in () for Reference Only.
3. Unless otherwise specified, tolerance : Decimal ± 0.05
4. Lead width dimension applies to the metallized terminal and is measured between 0.15mm and 0.30mm from the terminal tip.
5. Maximum package warpage is 0.05mm.
6. Maximum allowable burrs is 0.076mm in all directions.
7. Same as JEDEC MO-255UABD except:
No lead-pull-back, MIN. Package thickness = 0.45 not 0.50mm
Lead Length dim. = 0.45mm max. not 0.42mm.
8. The configuration of the pin #1 identifier is optional, but must be located within the zone indicated. The pin #1 identifier may be either a mold or mark feature.

IMPORTANT NOTICE AND DISCLAIMER

RENESAS ELECTRONICS CORPORATION AND ITS SUBSIDIARIES (“RENESAS”) PROVIDES TECHNICAL SPECIFICATIONS AND RELIABILITY DATA (INCLUDING DATASHEETS), DESIGN RESOURCES (INCLUDING REFERENCE DESIGNS), APPLICATION OR OTHER DESIGN ADVICE, WEB TOOLS, SAFETY INFORMATION, AND OTHER RESOURCES “AS IS” AND WITH ALL FAULTS, AND DISCLAIMS ALL WARRANTIES, EXPRESS OR IMPLIED, INCLUDING, WITHOUT LIMITATION, ANY IMPLIED WARRANTIES OF MERCHANTABILITY, FITNESS FOR A PARTICULAR PURPOSE, OR NON-INFRINGEMENT OF THIRD PARTY INTELLECTUAL PROPERTY RIGHTS.

These resources are intended for developers skilled in the art designing with Renesas products. You are solely responsible for (1) selecting the appropriate products for your application, (2) designing, validating, and testing your application, and (3) ensuring your application meets applicable standards, and any other safety, security, or other requirements. These resources are subject to change without notice. Renesas grants you permission to use these resources only for development of an application that uses Renesas products. Other reproduction or use of these resources is strictly prohibited. No license is granted to any other Renesas intellectual property or to any third party intellectual property. Renesas disclaims responsibility for, and you will fully indemnify Renesas and its representatives against, any claims, damages, costs, losses, or liabilities arising out of your use of these resources. Renesas' products are provided only subject to Renesas' Terms and Conditions of Sale or other applicable terms agreed to in writing. No use of any Renesas resources expands or otherwise alters any applicable warranties or warranty disclaimers for these products.

(Rev.1.0 Mar 2020)

Corporate Headquarters

TOYOSU FORESIA, 3-2-24 Toyosu,
Koto-ku, Tokyo 135-0061, Japan
www.renesas.com

Contact Information

For further information on a product, technology, the most up-to-date version of a document, or your nearest sales office, please visit:
www.renesas.com/contact/

Trademarks

Renesas and the Renesas logo are trademarks of Renesas Electronics Corporation. All trademarks and registered trademarks are the property of their respective owners.