

ISL62391, ISL62392, ISL62391C, ISL62392C

High-Efficiency, Triple-Output System Power Supply Controller for Notebook Computers

FN6666
Rev 8.00
August 25, 2015

The ISL62391, ISL62392, ISL62391C and ISL62392C controller generate supply voltages for battery-powered systems. It includes two pulse-width modulation (PWM) controllers, adjustable from 0.6V to 5.5V, and a linear regulator (LDO3) that generates a fixed 3.3V and can deliver up to 100mA. The ISL62391, ISL62392, ISL62391C and ISL62392C include on-board power-up sequencing, a power-good (PGOOD) output, digital soft-start, and internal soft-stop output discharge that prevents negative voltages on shutdown.

The patented R³ PWM control scheme provides a low jitter system with fast response to load transients. Light-load efficiency is improved with period-stretching discontinuous conduction mode (DCM) operation. To eliminate noise in audio frequency applications, an ultrasonic DCM mode is included, which limits the minimum switching frequency to 28kHz.

The ISL62391, ISL62391C and ISL62392, ISL62392C are identical except for how their overvoltage protection is handled. The ISL62391 and ISL62391C utilize a tri-state overvoltage scheme, whereas the ISL62392 and ISL62392C employ a soft-crowbar method.

The ISL62391, ISL62392, ISL62391C and ISL62392C are available in a 28 Ld 4x4 TQFN package and operate over the extended temperature range (-40°C to +100°C).

Features

- High Performance R³ Technology
- Fast Transient Response
- ±1% Output Voltage Accuracy
- 2 Fully Programmable Switch-Mode Power Supplies
- Programmable Switching Frequency
- Fixed 3.3V LDO Output
- Internal Soft-Start and Soft-Stop Output Discharge
- Wide Input Voltage Range: 5.5V to 25V
- Full and Ultrasonic Pulse-Skipping Mode
- Power-Good Indicator
- Overvoltage, Undervoltage and Overcurrent Protection
- Thermal Monitor and Protection
- Pb-Free (RoHS Compliant)

Applications

- Notebook and Sub-Notebook Computers
- PDAs and Mobile Communication Devices
- 3-Cell and 4-Cell Li+ Battery-Powered Devices

Pinout

ISL62391, ISL62392, ISL62391C, ISL62392C
(28 LD 4X4 TQFN)
TOP VIEW

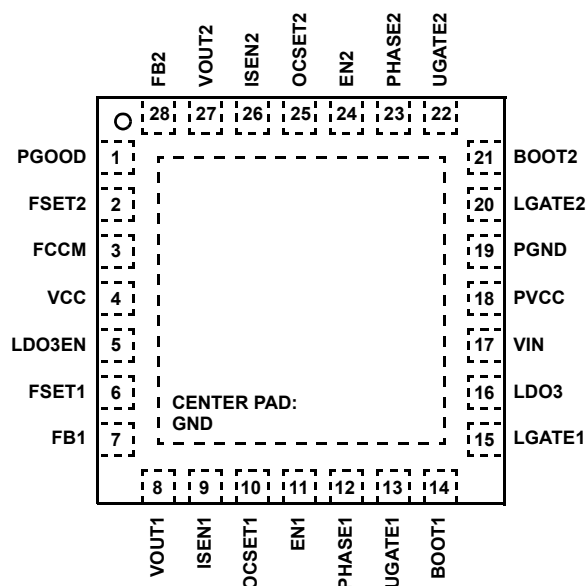

Ordering Information

PART NUMBER (Notes 1, 2)	PART MARKING	TEMP RANGE (°C)	PACKAGE (Pb-Free)	PKG. DWG. #
ISL62391HRTZ (Note 3)	623 91HRTZ	-10 to +100	28 Ld 4x4 TQFN	L28.4x4
ISL62392HRTZ (Note 3)	623 92HRTZ	-10 to +100	28 Ld 4x4 TQFN	L28.4x4
ISL62391CHRTZ (No longer available or supported)	62391C HRTZ	-10 to +100	28 Ld 4x4 TQFN	L28.4x4
ISL62392CHRTZ	62392C HRTZ	-10 to +100	28 Ld 4x4 TQFN	L28.4x4
ISL62391IRTZ (Note 3)	623 91IRTZ	-40 to +100	28 Ld 4x4 TQFN	L28.4x4
ISL62392IRTZ (Note 3)	623 92IRTZ	-40 to +100	28 Ld 4x4 TQFN	L28.4x4
ISL62391CIRTZ (No longer available or supported)	62391C IRTZ	-40 to +100	28 Ld 4x4 TQFN	L28.4x4
ISL62392CIRTZ	62392C IRTZ	-40 to +100	28 Ld 4x4 TQFN	L28.4x4

NOTES:

1. Add "-T*" suffix for tape and reel. Please refer to TB347 for details on reel specifications.
2. These Intersil Pb-free plastic packaged products employ special Pb-free material sets, molding compounds/die attach materials, and 100% matte tin plate plus anneal (e3 termination finish, which is RoHS compliant and compatible with both SnPb and Pb-free soldering operations). Intersil Pb-free products are MSL classified at Pb-free peak reflow temperatures that meet or exceed the Pb-free requirements of IPC/JEDEC J STD-020.
3. Not Recommended for New Designs. No Recommended Replacement.

Absolute Maximum Ratings

VIN to GND	-0.3V to +28V
VCC, PGOOD, PVCC to GND	-0.3V to +7.0V
EN _{1,2} , LDO3EN	-0.3V to GND, VCC +0.3V
VOUT _{1,2} , FB _{1,2} , FSET _{1,2}	-0.3V to GND, VCC +0.3V
PHASE _{1,2} to GND	(DC) -0.3V to +28V
($<100\text{ns}$ Pulse Width, $10\mu\text{J}$)	-5.0V
BOOT _{1,2} to GND	-0.3V to +33V
BOOT _{1,2} to PHASE _{1,2}	-0.3V to +7V
UGATE _{1,2}	(DC) -0.3V to PHASE _{1,2} , BOOT _{1,2} +0.3V
($<200\text{ns}$ Pulse Width, $20\mu\text{J}$)	-4.0V
LGATE _{1,2}	(DC) -0.3V to GND, PVCC +0.3V
($<100\text{ns}$ Pulse Width, $4\mu\text{J}$)	-2.0V
LDO3 Current (Internal Regulator) Continuous	+100mA

Thermal Information

Thermal Resistance (Typical, Notes 4, 5)	θ_{JA} ($^{\circ}\text{C}/\text{W}$)	θ_{JC} ($^{\circ}\text{C}/\text{W}$)
TQFN Package	37	3.5
Junction Temperature Range	-55 $^{\circ}\text{C}$ to +150 $^{\circ}\text{C}$	
Operating Temperature Range		
ISL62391IRTZ)	-40 $^{\circ}\text{C}$ to +100 $^{\circ}\text{C}$	
ISL62392IRTZ)	-40 $^{\circ}\text{C}$ to +100 $^{\circ}\text{C}$	
Operating Temperature Range		
ISL62391HRTZ)	-10 $^{\circ}\text{C}$ to +100 $^{\circ}\text{C}$	
ISL62392HRTZ)	-10 $^{\circ}\text{C}$ to +100 $^{\circ}\text{C}$	
Storage Temperature	-65 $^{\circ}\text{C}$ to +150 $^{\circ}\text{C}$	
Pb-Free Reflow Profile	see link below	
	http://www.intersil.com/pbfree/Pb-FreeReflow.asp	

Recommended Operating Conditions

Ambient Temperature Range	
ISL62391IRTZ)	-40 $^{\circ}\text{C}$ to +100 $^{\circ}\text{C}$
ISL62392IRTZ)	-40 $^{\circ}\text{C}$ to +100 $^{\circ}\text{C}$
Ambient Temperature Range	
ISL62391HRTZ)	-10 $^{\circ}\text{C}$ to +100 $^{\circ}\text{C}$
ISL62392HRTZ)	-10 $^{\circ}\text{C}$ to +100 $^{\circ}\text{C}$
Supply Voltage (VIN to GND)	5.5V to 25V

CAUTION: Do not operate at or near the maximum ratings listed for extended periods of time. Exposure to such conditions may adversely impact product reliability and result in failures not covered by warranty.

NOTES:

- θ_{JA} is measured in free air with the component mounted on a high effective thermal conductivity test board with "direct attach" features. See Tech Brief TB379.
- For θ_{JC} , the "case temp" location is the center of the exposed metal pad on the package underside.

Electrical Specifications VIN = 12V, EN = VCC, TA = -40 $^{\circ}\text{C}$ to +100 $^{\circ}\text{C}$, unless otherwise noted. Typical values are at TA = +25 $^{\circ}\text{C}$.
Boldface limits apply over the operating temperature range.

PARAMETER	CONDITIONS	MIN (Note 7)	TYP	MAX (Note 7)	UNITS
LINEAR REGULATOR					
VIN Power-on Reset	Rising Threshold	5.3	5.4	5.5	V
	Hysteresis	20	80	150	mV
VIN Shutdown Supply Current	EN1 = EN2 = LDO3EN = 0		6	15	μA
VIN Standby Supply Current	EN1 = EN2 = 0, LDO3EN = 1		150	250	μA
LDO3 Output Voltage	I_LDO3 = 100mA	3.25	3.3	3.35	V
	I_LDO3 = 0mA	3.25	3.3	3.35	V
LDO3 Short-Circuit Current	LDO3 = GND		180		mA
LDO3EN Input Voltage	Rising edge	1.1		2.5	V
	Falling edge	0.94		1.06	V
LDO3EN Input Leakage Current	LDO3EN = 0 or VCC	-1		1	μA
LDO3 Discharge ON-resistance	LDO3EN = 0		36	60	Ω
PVCC POR Threshold			4.2		V
SMPS2 to PVCC Switchover Threshold		4.63	4.8	4.93	V
SMPS2 to PVCC Switchover Resistance	VOUT2 to PVCC, VOUT2 = 5V		2.5	3.2	Ω
MAIN SMPS CONTROLLERS					
VCC Input Bias Current	EN1 = EN2 = 1, FB1 = FB2 = 0.65V		2		mA
VCC Start-up Voltage	EN1 = EN2 = LDO3EN = GND	3.45	3.6	3.75	V

Electrical Specifications VIN = 12V, EN = VCC, T_A = -40°C to +100°C, unless otherwise noted. Typical values are at T_A = +25°C.
Boldface limits apply over the operating temperature range. (Continued)

PARAMETER	CONDITIONS	MIN (Note 7)	TYP	MAX (Note 7)	UNITS
VCC POR Threshold	Rising Edge	4.33	4.50	4.55	V
	Rising Edge (ISL62391HRTZ, ISL62392HRTZ, T _A = -10°C to +100°C)	4.35	4.50	4.55	V
	Falling Edge	4.08	4.20	4.30	V
	Falling Edge (ISL62391HRTZ, ISL62392HRTZ, T _A = -10°C to +100°C)	4.10	4.20	4.30	V
Reference Voltage			0.6		V
Regulation Accuracy	VOUT regulated to 0.6V	-1		1	%
FB Input Bias Current	FB = 0.6V	-12		30	nA
	FB = 0.6V (ISL62391HRTZ, ISL62392HRTZ, T _A = -10°C to +100°C)	-10		30	nA
Frequency Range		200		600	kHz
Frequency Set Accuracy	F _{SW} = 300kHz (Note 6)	-12		12	%
VOUT Voltage Adjust Range	VIN ≥ 6V for VOUT = 5.5V	0.6		5.5	V
VOUT Soft-discharge Resistance			14	50	Ω
PGOOD Pull-down Impedance			32	50	Ω
PGOOD Leakage Current	PGOOD = VCC		0	1	μA
Maximum PGOOD Sink Current			5		mA
PGOOD Soft-start Delay (From first EN = 1 to PGOOD = 1)	EN1 = EN2 = 1	2.20	2.75	3.70	ms
	EN1 = 1, EN2 = Floating or EN1 = Floating, EN2 = 1	4.50	5.60	7.60	ms
	EN1 = 1, EN2 = Floating or EN1 = Floating, EN2 = 1 (ISL62391HRTZ, ISL62392HRTZ, T _A = -10°C to +100°C)	4.50	5.60	7.50	ms
UGATE Pull-up ON-resistance	200mA source current		1.0	1.5	Ω
UGATE Source Current	UGATE-PHASE = 2.5V		2.0		A
UGATE Pull-down ON-resistance	250mA source current		1.0	1.5	Ω
UGATE Sink Current	UGATE-PHASE = 2.5V		2.0		A
LGATE Pull-up ON-resistance	250mA source current		1.0	1.5	Ω
LGATE Source Current	LGATE-PGND = 2.5V		2.0		A
LGATE Pull-down ON-resistance	250mA source current		0.5	0.9	Ω
LGATE Sink Current	LGATE-PGND = 2.5V		4.0		A
UGATE to LGATE Deadtime	UG falling to LG rising, no load		21		ns
LGATE to UGATE Deadtime	LG falling to UG rising, no load		21		ns
Bootstrap Diode Forward Voltage	2mA forward diode current		0.58		V
Bootstrap Diode Reverse Leakage Current	V _R = 25V		0.2	1	μA
FCCM Input Voltage	Low Level (DCM enabled)			0.8	V
	Float Level (audio filter enabled)	1.9		2.1	V
	High Level (forced CCM)	2.4			V
FCCM Input Leakage Current	FCCM = GND or VCC	-2		2	μA
Audio Filter Switching Frequency	FCCM floating		28		kHz
EN Input Voltage	Low Level (Clear fault level/SMPS off)			0.8	V
	Float Level (Delayed start)	1.9		2.1	V
	High Level (SMPS on)	2.4			V

Electrical Specifications $V_{IN} = 12V$, $EN = VCC$, $T_A = -40^{\circ}C$ to $+100^{\circ}C$, unless otherwise noted. Typical values are at $T_A = +25^{\circ}C$.
Boldface limits apply over the operating temperature range. (Continued)

PARAMETER	CONDITIONS	MIN (Note 7)	TYP	MAX (Note 7)	UNITS
EN Input Leakage Current	EN = GND or VCC	-3.5		3.5	μA
I _{SEN} Input Impedance	EN = VCC		600		$k\Omega$
I _{SEN} Input Leakage Current	EN = GND		0.1		μA
OCSET Input Impedance	EN = VCC		600		$k\Omega$
OCSET Input Leakage Current	EN = GND		0.1		μA
OCSET Current Source	EN = VCC	8.7	10.0	10.5	μA
	EN = VCC (ISL62391HRTZ, ISL62392HRTZ, $T_A = -10^{\circ}C$ to $+100^{\circ}C$)	9	10.0	10.5	μA
OCP (OCSET-I _{SEN}) Threshold		-1.75	0.0	1.75	mV
UVP Threshold	Falling edge, referenced to FB	80.9	84	87	%
	Falling edge, referenced to FB (ISL62391HRTZ, ISL62392HRTZ, $T_A = -10^{\circ}C$ to $+100^{\circ}C$)	81	84	87	%
OVP Threshold	Rising edge, referenced to FB	113	116	120	%
	Falling edge, referenced to FB	99.5	103	106	%
OTP Threshold	Rising edge		150		$^{\circ}C$
	Falling edge		135		

NOTES:

- F_{SW} accuracy reflects IC tolerance only; it does not include frequency variation due to V_{IN} , V_{OUT} , L_{OUT} , ESR_{COUT} , or other application specific parameters.
- Compliance to datasheet limits is assured by one or more methods: production test, characterization and/or design.

Functional Pin Description

PIN	NAME	FUNCTION
1	PGOOD	Open-drain power-good status outputs. Connect to VCC through a 100k resistor. Output will be high when all outputs are within regulation with no faults detected.
2	FSET2	Frequency control input for SMPS2. Connect a resistor to ground to program the switching frequency. The pin output is a pulsed current and requires a decoupling capacitor to average the signal.
3	FCCM	Logic input to control efficiency mode. Logic high forces continuous conduction mode (CCM). Logic low allows full discontinuous conduction mode (DCM). Float this pin for ultrasonic DCM operation.
4	VCC	Analog power supply input for reference voltages and currents. Bypass to ground with a 1µF ceramic capacitor near the IC.
5	LDO3EN	Logic input for enabling and disabling the LDO3 linear regulator. Positive logic input.
6	FSET1	Frequency control input for SMPS1. Connect a resistor to ground to program the switching frequency. The pin output is a pulsed current and requires a decoupling capacitor to average the signal.
7	FB1	SMPS1 feedback input used for output voltage programming and regulation.
8	VOUT1	SMPS1 output voltage sense input. Used for soft-discharge.
9	ISEN1	SMPS1 DCR current sense input. Used for overcurrent protection and R ³ regulation.
10	OCSET1	Input from DCR current-sensing network used to program the overcurrent shutdown threshold for SMPS1.
11	EN1	Logic input to enable and disable SMPS1. A logic high will immediately enable SMPS1. Floating this pin will enable SMPS1 only after SMPS2 has been enabled and achieved regulation. A logic low disables SMPS1.
12	PHASE1	SMPS1 switching node for high-side gate drive return and synthetic ripple modulation. Connect to the switching NMOS source, the synchronous NMOS drain, and the output inductor for SMPS1.
13	UGATE1	High-side NMOS gate drive output for SMPS1. Connect to the gate of the SMPS1 switching FET.
14	BOOT1	SMPS1 bootstrap input for the switching NMOS gate drivers. Connect to SMPS1 PHASE with a ceramic capacitor of 0.22µF.
15	LGATE1	Low-side NMOS gate drive output for SMPS1. Connect to the gate of the SMPS1 synchronous FET.
16	LDO3	3.3V linear regulator output, capable of providing 100mA continuous current. Bypass to ground with a 4.7µF ceramic capacitor.
17	VIN	Feed-forward input for line voltage transient compensation. Connect to the power train input voltage.
18	PVCC	5V power source for SMPS gate drive current. Bypass to ground with a 4.7µF ceramic capacitor.
19	PGND	Power ground for SMPS1 and SMPS2. This provides a return path for synchronous FET switching currents.
20	LGATE2	Low-side NMOS gate drive output for SMPS2. Connect to the gate of the SMPS2 synchronous FET.
21	BOOT2	SMPS2 bootstrap input for the switching NMOS gate drivers. Connect to SMPS2 PHASE with a ceramic capacitor of 0.22µF.
22	UGATE2	High-side NMOS gate drive output for SMPS2. Connect to the gate of the SMPS2 switching FET.
23	PHASE2	SMPS2 switching node for high-side gate drive return and synthetic ripple modulation. Connect to the switching NMOS source, the synchronous NMOS drain, and the output inductor for SMPS2.
24	EN2	Logic input to enable and disable SMPS2. A logic high will immediately enable SMPS2. Floating this pin will enable SMPS2 only after SMPS1 has been enabled and achieved regulation. A logic low disables SMPS2.
25	OCSET2	Input from DCR current-sensing network used to program the overcurrent shutdown threshold for SMPS2.
26	ISEN2	SMPS2 DCR current sense input. Used for overcurrent protection and R ³ regulation.
27	VOUT2	SMPS2 output voltage sense input. Used for soft-discharge and switchover for PVCC 5V LDO.
28	FB2	SMPS2 feedback input used for output voltage programming and regulation.
Bottom Pad	GND	Analog ground for analog and logic signals.

Typical Application Circuits (Continued)

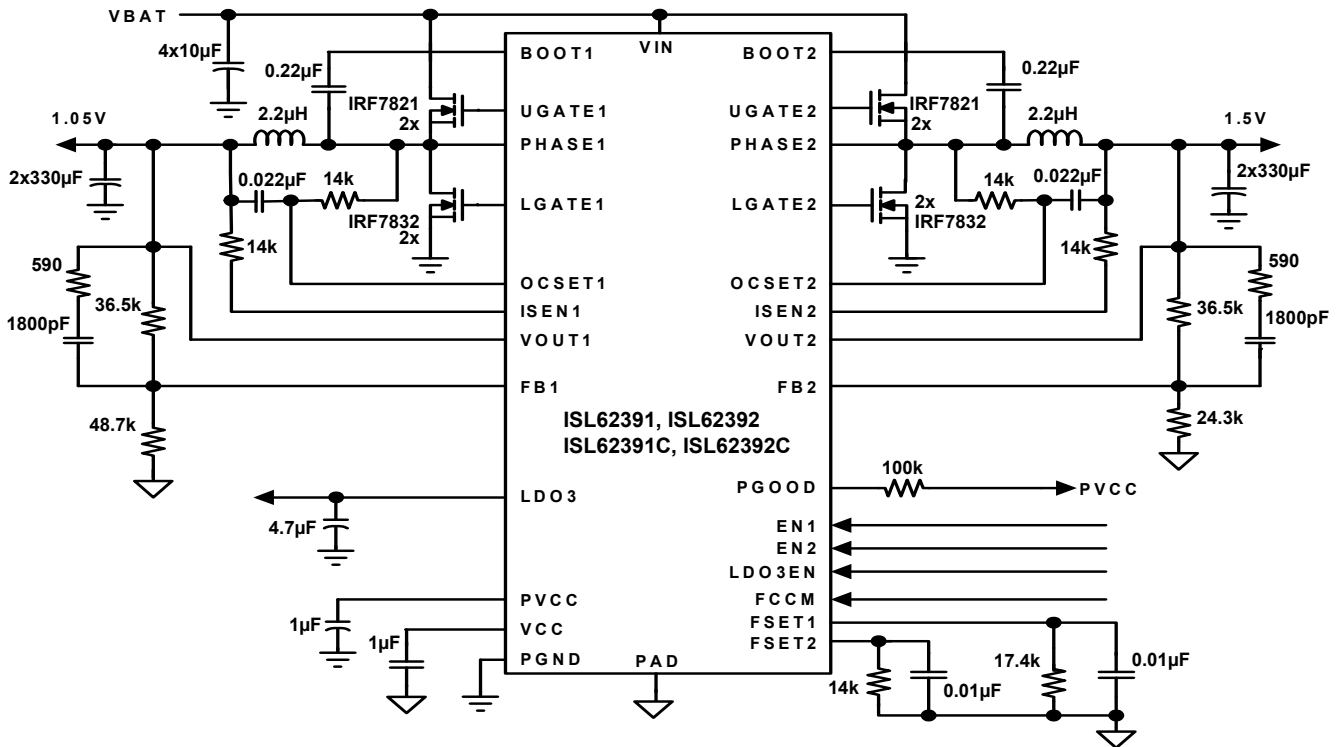

FIGURE 3. TYPICAL CHIP SET APPLICATION CIRCUIT WITH INDUCTOR DCR CURRENT SENSE



FIGURE 4. TYPICAL CHIP SET APPLICATION CIRCUIT WITH RESISTOR SENSE

Block Diagram



*In addition to being used for regulation, VOUT2 will also provide power for PVCC when it is programmed to 5V.

Typical Performance Curves



FIGURE 5. CHANNEL 1 EFFICIENCY AT $V_O = 3.3V$, DEM OPERATION. HIGH-SIDE 1xIRF7821, $r_{DS(ON)} = 9.1m\Omega$; LOW-SIDE 1xIRF7832, $r_{DS(ON)} = 4m\Omega$; $L = 4.7\mu H$, $DCR = 14.3m\Omega$; CCM $F_{SW} = 270kHz$



FIGURE 6. CHANNEL 2 EFFICIENCY AT $V_O = 5V$, DEM OPERATION. HIGH-SIDE 1xIRF7821, $r_{DS(ON)} = 9.1m\Omega$; LOW-SIDE 1xIRF7832, $r_{DS(ON)} = 4m\Omega$; $L = 4.7\mu H$, $DCR = 14.3m\Omega$; CCM $F_{SW} = 330kHz$

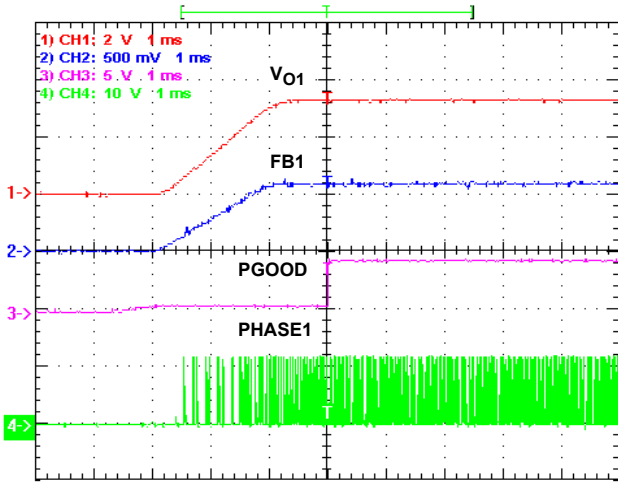

FIGURE 7. POWER-ON, $V_{IN} = 12V$, LOAD = 5A, $V_O = 3.3V$

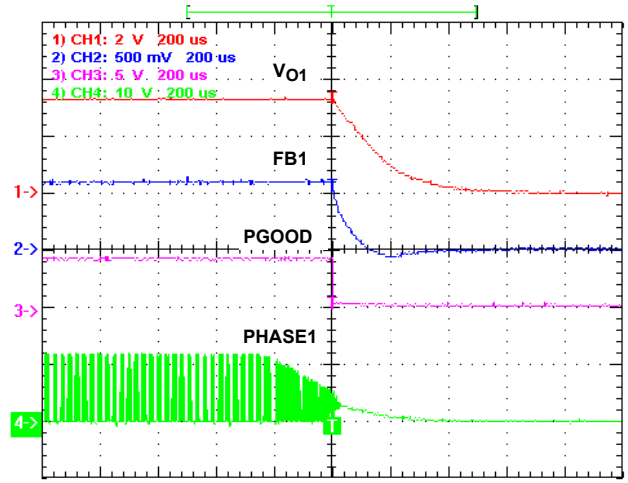

FIGURE 8. POWER-OFF, $V_{IN} = 12V$, $I_O = 5A$, $V_O = 3.3V$



FIGURE 9. ENABLE CONTROL, EN1 = HIGH, $V_{IN} = 12V$, $V_O = 3.3V$, $I_O = 5A$



FIGURE 10. ENABLE CONTROL, EN1 = LOW, $V_{IN} = 12V$, $V_O = 3.3V$, $I_O = 5A$

Typical Performance Curves (Continued)



FIGURE 11. CCM STEADY-STATE OPERATION, $V_{IN} = 12V$, $V_{O1} = 3.3V$, $I_{O1} = 5A$, $V_{O2} = 5V$, $I_{O2} = 5A$



FIGURE 12. DCM STEADY-STATE OPERATION, $V_{IN} = 12V$, $V_{O1} = 3.3V$, $I_{O1} = 0.2A$, $V_{O2} = 5V$, $I_{O2} = 0.2A$



FIGURE 13. AUDIO FILTER OPERATION, $V_{IN} = 12V$, $V_{O1} = 3.3V$, $V_{O2} = 5V$, NO LOAD

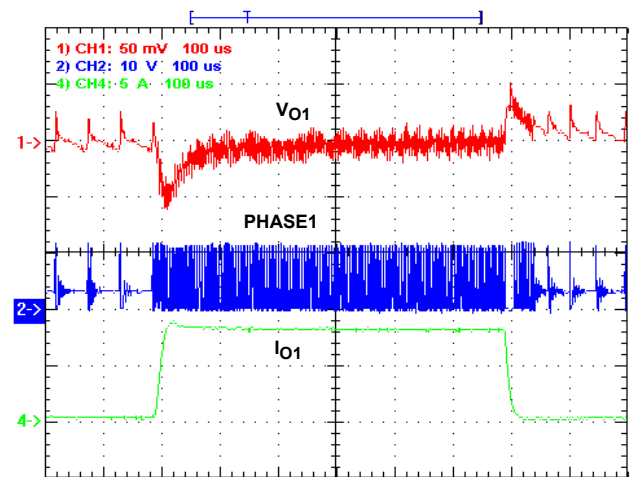

FIGURE 14. TRANSIENT RESPONSE, $V_{IN} = 12V$, $V_O = 3.3V$, $I_O = 0.1A/8.1A @ 2.5A/\mu s$

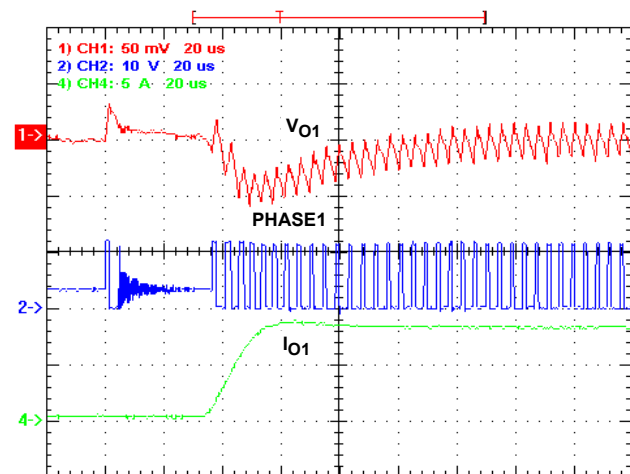

FIGURE 15. LOAD INSERTION RESPONSE, $V_{IN} = 12V$, $V_O = 3.3V$, $I_O = 0.1A/8.1A @ 2.5A/\mu s$

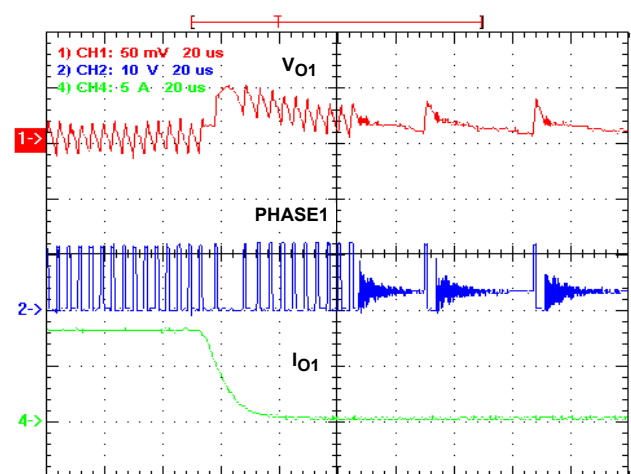

FIGURE 16. LOAD RELEASE RESPONSE, $V_{IN} = 12V$, $V_O = 3.3V$, $I_O = 0.1A/8.1A @ 2.5A/\mu s$

Typical Performance Curves (Continued)

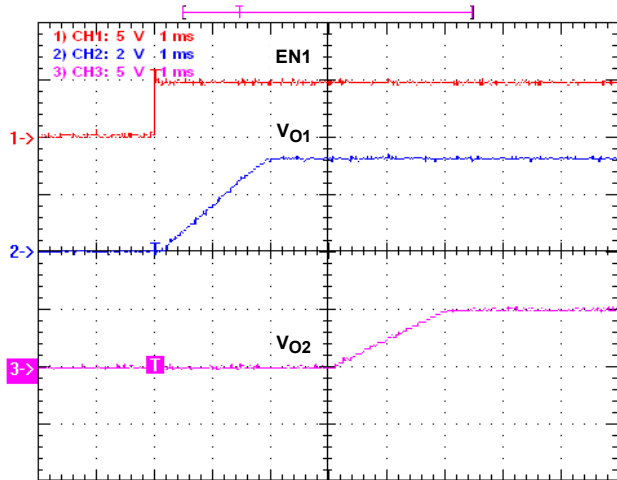

FIGURE 17. DELAYED START, $V_{IN} = 12V$, $V_{O1} = 3.3V$, $V_{O2} = 5V$, EN2 = FLOAT, NO LOAD

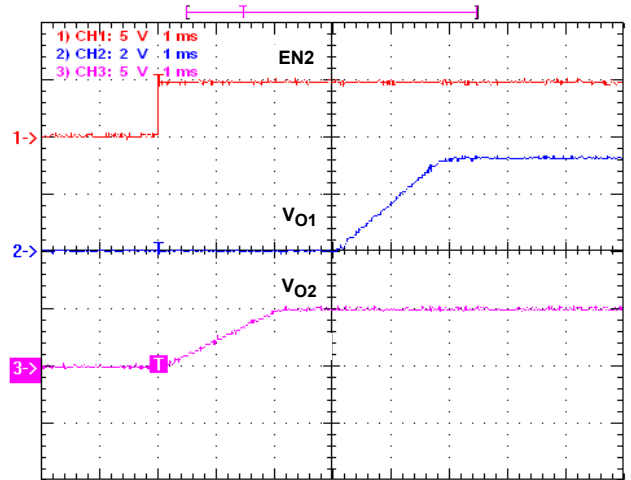

FIGURE 18. DELAYED START, $V_{IN} = 12V$, $V_{O1} = 3.3V$, $V_{O2} = 5V$, EN1 = FLOAT, NO LOAD

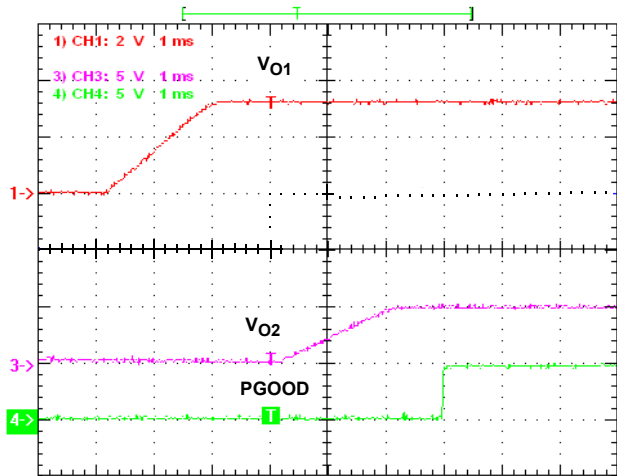

FIGURE 19. DELAYED START, $V_{IN} = 12V$, $V_{O1} = 3.3V$, $V_{O2} = 5V$, EN1 = 1, EN2 = FLOAT, NO LOAD

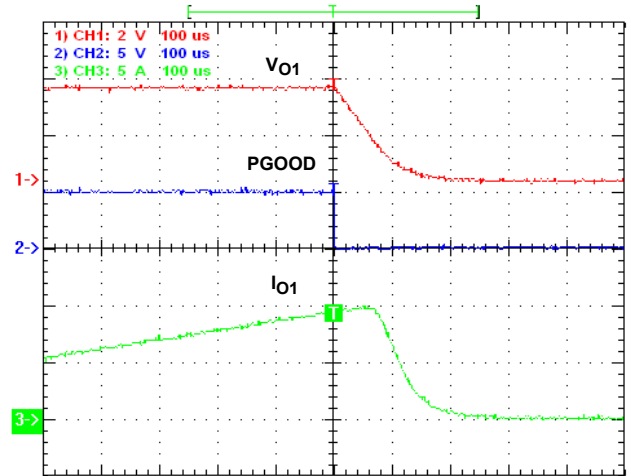

FIGURE 20. OVERCURRENT PROTECTION, $V_{IN} = 12V$, $V_O = 3.3V$

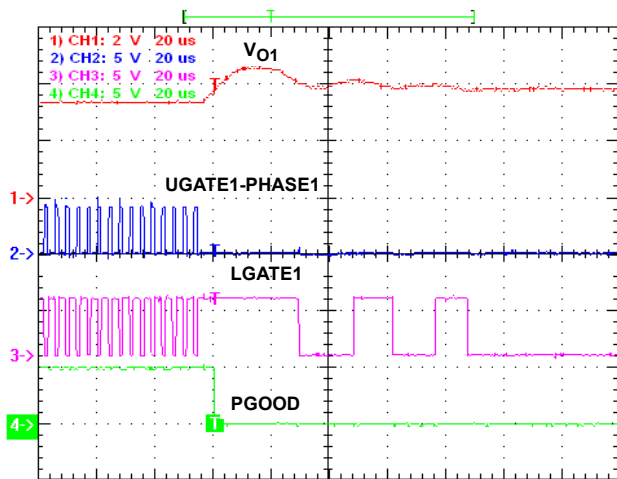

FIGURE 21. CROWBAR OVERVOLTAGE PROTECTION, $V_{IN} = 12V$, $V_O = 3.3V$, NO LOAD

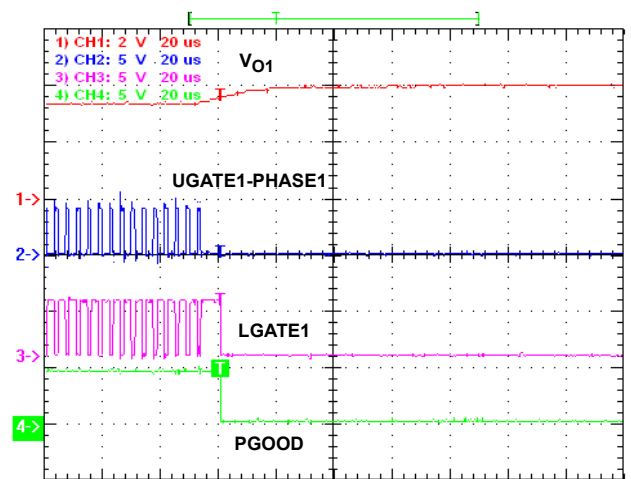

FIGURE 22. TRI-STATE OVERVOLTAGE PROTECTION, $V_{IN} = 12V$, $V_O = 3.3V$, NO LOAD

Theory of Operation

Three Output Controller

The ISL62391, ISL62392, ISL62391C and ISL62392C generate three regulated output voltages. Two are produced with switch-mode power supplies (SMPS), and the third by a low dropout linear regulator (LDO). An additional 5V LDO (PVCC) is used to power the chip during operation, allowing the ISL62391, ISL62392, ISL62391C and ISL62392C to regulate all outputs from a single power source (VIN) with no need for a separate quiescent supply. This makes the ISL62391, ISL62392, ISL62391C and ISL62392C an ideal choice as system regulator for notebook PCs. Because the two SMPS channels are identical and almost entirely independent, all conclusions drawn apply to both channels unless otherwise noted.

Modulator and Switching Frequency

The ISL62391, ISL62392, ISL62391C and ISL62392C modulator feature Intersil's R³ technology, a hybrid of fixed frequency PWM and variable frequency hysteretic control. Intersil's R³ technology can simultaneously affect the PWM switching frequency and PWM duty cycle in response to input voltage and output load transients. The R³ modulator synthesizes an AC signal, V_R, which is an analog representation of the output inductor ripple current. The duty-cycle of V_R is the result of charge and discharge current through a ripple capacitor, C_R. The current through C_R is provided by a transconductance amplifier that measures the VIN and VO pin voltages. The positive slope of V_R can be written as Equation 1:

$$V_{RPOS} = g_m \cdot (V_{IN} - V_{OUT}) \quad (\text{EQ. 1})$$

The negative slope of V_R can be written as Equation 2:

$$V_{RNEG} = g_m \cdot V_{OUT} \quad (\text{EQ. 2})$$

Where g_m is the gain of the transconductance amplifier.



FIGURE 23. MODULATOR WAVEFORMS DURING LOAD TRANSIENT

A window voltage V_W is referenced with respect to the error amplifier output voltage V_{COMP}, creating an envelope into which the ripple voltage V_R is compared. The amplitude of V_W is set by a resistor, R_W, connected across the FSET and GND pins. The V_R, V_{COMP}, and V_W signals feed into a window comparator in which V_{COMP} is the lower threshold voltage and V_W is the higher threshold voltage. Figure 23 shows PWM pulses being generated as V_R traverses the V_W and V_{COMP} thresholds. The PWM switching frequency is proportional to the slew rates of the positive and negative slopes of V_R; it is inversely proportional to the voltage between V_W and V_{COMP}. Equation 3 illustrates how to calculate the window size based on output voltage and frequency set resistor.

$$V_W = g_m \cdot V_{OUT} \cdot (1 - D) \cdot R_W \quad (\text{EQ. 3})$$

The frequency can be expressed in Equation 4:

$$F_{SW} = \frac{1}{K \cdot R_W} \quad (\text{EQ. 4})$$

Inverting Equation 4 allows easy selection of R_W for a desired F_{SW}:

$$R_W = \frac{1}{K \cdot F_{SW}} \quad (\text{EQ. 5})$$

For Equations 3 through 5:

$$g_m = 1.66\mu\text{s}$$

$$K = 1.7 \times 10^{-10} (\pm 20\%)$$

$$D = V_{OUT}/V_{IN}$$

Power-On Reset

The ISL62391, ISL62392, ISL62391C and ISL62392C are disabled until the voltage at the VIN pin has increased above the rising power-on reset (POR) threshold. Conversely, the controller will be disabled when the voltage at the VIN pin decreases below the falling POR threshold.

In addition to VIN POR, the PVCC pin is also monitored. If its voltage falls below 4.2V, the SMPS outputs will be shut down. This ensures that there is sufficient BOOT voltage to enhance the upper MOSFET.

EN, Soft-Start and PGOOD

The ISL62391, ISL62392, ISL62391C and ISL62392C use a digital soft-start circuit to ramp the output voltage of each SMPS to the programmed regulation setpoint at a predictable slew rate. The slew rate of the soft-start sequence has been selected to limit the in-rush current through the output capacitors as they charge to the desired regulation voltage. When the EN pins are pulled above their rising thresholds, the PGOOD Soft-Start Delay, t_{SS}, starts and the output voltage begins to rise. The FB pin ramps to 0.6V in approximately 1.5ms and the PGOOD pin goes to high impedance approximately 1.25ms after the FB pin voltage reaches 0.6V.



FIGURE 24. SOFT-START SEQUENCE FOR ONE SMPS

The PGOOD pin indicates when the converter is capable of supplying regulated voltage. It is an undefined impedance if V_{IN} is not above the rising POR threshold or below the POR falling threshold. When a fault is detected, the ISL62391, ISL62392, ISL62391C and ISL62392C will turn on the open-drain NMOS, which will pull PGOOD low with a nominal impedance of 32Ω. This will flag the system that one of the output voltages is out of regulation.

Separate enable pins allow for full soft-start sequencing. Because low shutdown quiescent current is necessary to prolong battery life in notebook applications, the PVCC 5V LDO is held off until any of the three enable signals (EN1, EN2 or LDO3EN) are pulled high. Soft-start of all outputs will only start until after PVCC is above the 4.2V POR threshold. In addition to user-programmable sequencing, the ISL62391, ISL62392, ISL62391C and ISL62392C include a pre-programmed sequential SMPS soft-start feature. Table 1 shows the SMPS enable truth table.

TABLE 1. SMPS ENABLE SEQUENCE LOGIC

EN1	EN2	START-UP SEQUENCE
0	0	All SMPS outputs OFF
0	FLOAT	All SMPS outputs OFF
0	1	SMPS1 OFF, SMPS2 ON
FLOAT	0	All SMPS outputs OFF
FLOAT	FLOAT	All SMPS outputs OFF
FLOAT	1	SMPS1 enables after SMPS2 is in regulation
1	0	SMPS1 ON, SMPS2 OFF
1	FLOAT	SMPS2 enables after SMPS1 is in regulation
1	1	All SMPS outputs ON simultaneously

VCC

The VCC nominal operation voltage is 5V. If EN1, EN2 and LDO3EN are all logic low, the VCC start-up voltage is 3.6V when V_{IN} is applied on ISL62391, ISL62392, ISL62391C and ISL62392C. PVCC is held off until any of the three enable signals (EN1, EN2 or LDO3EN) is pulled high. When PVCC is

above the 4.2V VCC POR threshold, VCC will switchover to PVCC internally.

After V_{IN} is applied, the VCC start-up 3.6V voltage can be used as the logic high signal of any of EN1, EN2 and LDO3EN to enable PVCC if there is no other power supply on the board.

MOSFET Gate-Drive Outputs LGATE and UGATE

The ISL62391, ISL62392, ISL62391C and ISL62392C have internal gate-drivers for the high-side and low-side N-Channel MOSFETs. The low-side gate-drivers are optimized for low duty-cycle applications where the low-side MOSFET conduction losses are dominant, requiring a low $r_{DS(ON)}$ MOSFET. The LGATE pull-down resistance is small in order to clamp the gate of the MOSFET below the $V_{GS(th)}$ at turn-off. The current transient through the gate at turn-off can be considerable because the gate charge of a low $r_{DS(ON)}$ MOSFET can be large. Adaptive shoot-through protection prevents a gate-driver output from turning on until the opposite gate-driver output has fallen below approximately 1V. The dead-time shown in Figure 25 is extended by the additional period that the falling gate voltage stays above the 1V threshold. The typical dead-time is 21ns. The high-side gate-driver output voltage is measured across the UGATE and PHASE pins while the low-side gate-driver output voltage is measured across the LGATE and PGND pins. The power for the LGATE gate-driver is sourced directly from the PVCC pin. The power for the UGATE gate-driver is sourced from a “boot” capacitor connected across the BOOT and PHASE pins. The boot capacitor is charged from the 5V PVCC supply through a “boot diode” each time the low-side MOSFET turns on, pulling the PHASE pin low. The ISL62391, ISL62392, ISL62391C and ISL62392C have integrated boot diodes connected from the PVCC pins to BOOT pins.

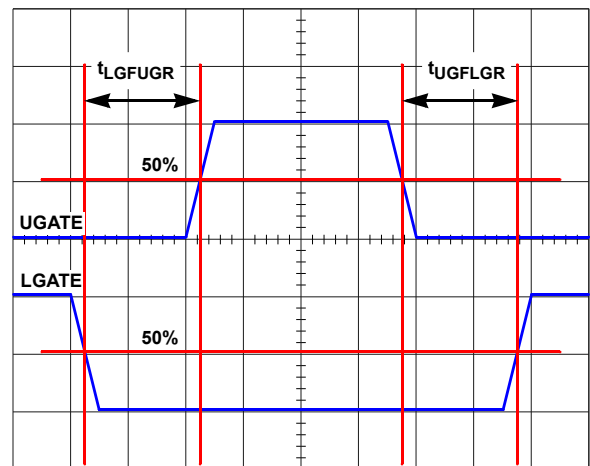

FIGURE 25. LGATE AND UGATE DEAD-TIME

Diode Emulation

FCCM is a logic input that controls the power state of the ISL62391, ISL62392, ISL62391C and ISL62392C. If forced high, the ISL62391, ISL62392, ISL62391C and ISL62392C will operate in forced continuous-conduction-mode (CCM) over the entire load range. This will produce the best transient response

to all load conditions, but will have increased light-load power loss. If FCCM is forced low, the ISL62391, ISL62392, ISL62391C and ISL62392C will automatically operate in Diode Emulation Mode (DEM) at light load to optimize efficiency in the entire load range. The transition is automatically achieved by detecting the load current and turning off LGATE when the inductor current reaches 0A.

Positive-going inductor current flows from either the source of the high-side MOSFET, or the drain of the low-side MOSFET. Negative-going inductor current flows into the drain of the low-side MOSFET. When the low-side MOSFET conducts positive inductor current, the phase voltage will be negative with respect to the GND and PGND pins. Conversely, when the low-side MOSFET conducts negative inductor current, the phase voltage will be positive with respect to the GND and PGND pins. The ISL62391, ISL62392, ISL62391C and ISL62392C monitor the phase voltage when the low-side MOSFET is conducting inductor current to determine its direction.

When the output load current is greater than or equal to $\frac{1}{2}$ the inductor ripple current, the inductor current is always positive, and the converter is always in CCM. The ISL62391, ISL62392, ISL62391C and ISL62392C minimize the conduction loss in this condition by forcing the low-side MOSFET to operate as a synchronous rectifier.

When the output load current is less than $\frac{1}{2}$ the inductor ripple current, negative inductor current occurs. Sinking negative inductor through the low-side MOSFET lowers efficiency through unnecessary conduction losses. The ISL62391, ISL62392, ISL62391C and ISL62392C automatically enter DEM after the PHASE pin has detected positive voltage and LGATE was allowed to go high for 8 consecutive PWM switching cycles. The ISL62391, ISL62392, ISL62391C and ISL62392C will turn off the low-side MOSFET once the phase voltage turns positive, indicating negative inductor current. The ISL62391, ISL62392, ISL62391C and ISL62392C will return to CCM on the following cycle after the PHASE pin detects negative voltage, indicating that the body diode of the low-side MOSFET is conducting positive inductor current.

Efficiency can be further improved with a reduction of unnecessary switching losses by reducing the PWM frequency. It is characteristic of the R^3 architecture for the PWM frequency to decrease while in diode emulation. The extent of the frequency reduction is proportional to the reduction of load current. Upon entering DEM, the PWM frequency makes an initial step-reduction because of a 33% step-increase of the window voltage V_W .

Because the switching frequency in DEM is a function of load current, very light load conditions can produce frequencies well into the audio band. This can be problematic if audible noise is coupled into audio amplifier circuits. To prevent this from occurring, the ISL62391, ISL62392, ISL62391C and ISL62392C allow the user to float the FCCM input. This will

allow DEM at light loads, but will prevent the switching frequency from going below $\sim 28\text{kHz}$ to prevent noise injection to the audio band. A timer is reset each PWM pulse. If the timer exceeds $30\mu\text{s}$, LGATE is turned on, causing the ramp voltage to reduce until another UGATE is commanded by the voltage loop.

Overcurrent Protection

The overcurrent protection (OCP) setpoint is programmed with resistor, R_{OCSET} , that is connected across the OCSET and PHASE pins.

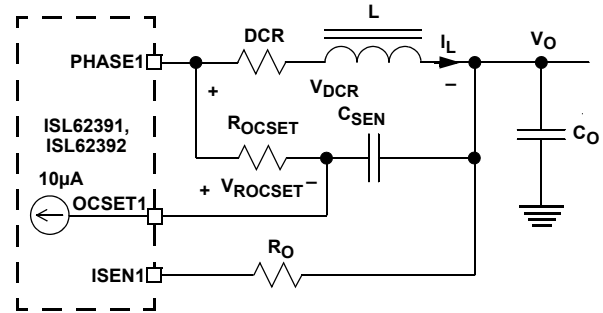

FIGURE 26. OVERCURRENT-SET CIRCUIT

Figure 26 shows the overcurrent-set circuit for SMPS1. The inductor consists of inductance L and the DC resistance (DCR). The inductor DC current I_L creates a voltage drop across DCR, which is given by Equation 6:

$$V_{DCR} = I_L \cdot DCR \quad (\text{EQ. 6})$$

The ISL62391, ISL62392, ISL62391C and ISL62392C sink a $10\mu\text{A}$ current into the OCSET1 pin, creating a DC voltage drop across the resistor R_{OCSET} , which is given by Equation 7:

$$V_{ROCSET} = 10\mu\text{A} \cdot R_{OCSET} \quad (\text{EQ. 7})$$

Resistor R_O is connected between the ISEN1 pin and the actual output voltage of the converter. During normal operation, the ISEN1 pin is a high impedance path, therefore there is no voltage drop across R_O . The DC voltage difference between the OCSET1 pin and the ISEN1 pin can be established using Equation 8:

$$V_{OCSET1} - V_{ISEN1} = I_L \cdot DCR - 10\mu\text{A} \cdot R_{OCSET} \quad (\text{EQ. 8})$$

The ISL62391, ISL62392, ISL62391C and ISL62392C monitor the OCSET1 pin and the ISEN1 pin voltages. Once the OCSET1 pin voltage is higher than the ISEN1 pin voltage for more than $10\mu\text{s}$, the ISL62391, ISL62392, ISL62391C and ISL62392C declare an OCP fault. The value of R_{OCSET} is then written as Equation 9:

$$R_{OCSET} = \frac{I_{OC} \cdot DCR}{10\mu\text{A}} \quad (\text{EQ. 9})$$

Where:

- R_{OCSET} (Ω) is the resistor used to program the overcurrent setpoint
- I_{OC} is the output current threshold that will activate the OCP circuit
- DCR is the inductor DC resistance

For example, if I_{OC} is 20A and DCR is 4.5m Ω , the choice of R_{OCSET} is $R_{OCSET} = 20A \times 4.5m\Omega / 10\mu A = 9k\Omega$.

Resistor R_{OCSET} and capacitor C_{SEN} form an R-C network to sense the inductor current. To sense the inductor current correctly, not only in DC operation but also during dynamic operation, the R-C network time constant $R_{OCSET} \cdot C_{SEN}$ needs to match the inductor time constant L/DCR . The value of C_{SEN} is then written as Equation 10:

$$C_{SEN} = \frac{L}{R_{OCSET} \cdot DCR} \quad (\text{EQ. 10})$$

For example, if L is 1.5 μ H, DCR is 4.5m Ω , and R_{OCSET} is 9k Ω , the choice of $C_{SEN} = 1.5\mu H / (9k\Omega \times 4.5m\Omega) = 0.037\mu F$.

Upon converter start-up, the C_{SEN} capacitor bias is 0V. To prevent false OCP during this time, a 10 μ A current source flows out of the ISEN1 pin, generating a voltage drop on the R_O resistor, which should be chosen to have the same resistance as R_{OCSET} . When the PGOOD pin goes high, the ISEN1 pin current source will be removed.

When an OCP fault is declared, the PGOOD pin will pull-down to 32 Ω and latch-off the converter. The fault will remain latched until the EN pin has been pulled below the falling EN threshold voltage, or until V_{IN} has decayed below the falling POR threshold.

When using a discrete current sense resistor, inductor time-constant matching is not required. Equation 7 remains unchanged, but Equation 8 is modified in Equation 11:

$$V_{OCSET1} - V_{ISEN1} = I_L \cdot R_{SENSE} - 10\mu A \cdot R_{OCSET} \quad (\text{EQ. 11})$$

Furthermore, Equation 9 is changed in Equation 12:

$$R_{OCSET} = \frac{I_{OC} \cdot R_{SENSE}}{10\mu A} \quad (\text{EQ. 12})$$

Where R_{SENSE} is the series power resistor for sensing inductor current. For example, with an $R_{SENSE} = 1m\Omega$ and an OCP target of 10A, $R_{OCSET} = 1k\Omega$.

Overvoltage Protection

The OVP fault detection circuit triggers after the FB pin voltage is above the rising overvoltage threshold for more than 2 μ s. The FB pin voltage is 0.6V in normal operation. The rising overvoltage threshold is typically 116% of that value, or $1.16 \times 0.6V = 0.696V$.

For ISL62391, ISL62392, ISL62391C and ISL62392C, when an OVP fault is declared, the PGOOD pin will pull-down with 32 Ω and latch-off the converter. The OVP fault will remain latched

until the EN pin has been pulled below the falling EN threshold voltage, or until V_{IN} has decayed below the falling POR threshold. During the latch condition, the ISL62391 and ISL62391C will tri-state the PHASE node by turning both UGATE and LGATE off until the latch is cleared.

Although latched, the ISL62392 and ISL62392C LGATE gate-driver output will retain the ability to toggle the low-side MOSFET on and off in response to the output voltage transversing the OVP rising and falling thresholds. The LGATE gate-driver will turn on the low-side MOSFET to discharge the output voltage, thus protecting the load from potentially damaging voltage levels. The LGATE gate-driver will turn off the low-side MOSFET once the FB pin voltage is lower than the falling overvoltage threshold for more than 2 μ s. The falling overvoltage threshold is typically 106% of the reference voltage, or $1.06 \times 0.6V = 0.636V$. This soft-crowbar process repeats as long as the output voltage fault is present, allowing the ISL62392 and ISL62392C to protect against persistent overvoltage conditions.

Undervoltage Protection

The UVP fault detection circuit triggers after the FB pin voltage is below the undervoltage threshold for more than 2 μ s. The undervoltage threshold is typically 86% of the reference voltage, or $0.86 \times 0.6V = 0.516V$. If a UVP fault is declared, the PGOOD pin will pull-down with 32 Ω and latch-off the converter. The fault will remain latched until the EN pin has been pulled below the falling enable threshold, or if V_{IN} has decayed below the falling POR threshold.

Programming the Output Voltage

When the converter is in regulation, there will be 0.6V between the FB and GND pins. Connect a two-resistor voltage divider across the OUT and GND pins with the output node connected to the FB pin, as shown in Figure 27. Scale the voltage-divider network such that the FB pin is 0.6V with respect to the GND pin when the converter is regulating at the desired output voltage. The output voltage can be programmed from 0.6V to 5.5V.

Programming the output voltage is written as Equation 13:

$$V_{OUT} = V_{REF} \cdot \left(1 + \frac{R_{TOP}}{R_{BOTTOM}} \right) \quad (\text{EQ. 13})$$

Where:

- V_{OUT} is the desired output voltage of the converter
- The voltage to which the converter regulates the FB pin is the V_{REF} (0.6V)
- R_{TOP} is the voltage-programming resistor that connects from the FB pin to the converter output. In addition to setting the output voltage, this resistor is part of the loop compensation network
- R_{BOTTOM} is the voltage-programming resistor that connects from the FB pin to the GND pin

Choose R_{TOP} first when compensating the control loop, and then calculate R_{BOTTOM} according to Equation 14:

$$R_{\text{BOTTOM}} = \frac{V_{\text{REF}} \cdot R_{\text{TOP}}}{V_{\text{OUT}} - V_{\text{REF}}} \quad (\text{EQ. 14})$$

Compensation Design

Figure 27 shows the recommended Type-II compensation circuit. The FB pin is the inverting input of the error amplifier. The COMP signal, the output of the error amplifier, is inside the chip and unavailable to users. C_{INT} is a 100pF capacitor integrated inside the IC that connects across the FB pin and the COMP signal. R_{TOP} , R_{FB} , C_{FB} and C_{INT} form the Type-II compensator. The frequency domain transfer function is given by Equation 15:

$$G_{\text{COMP}}(s) = \frac{1 + s \cdot (R_{\text{TOP}} + R_{\text{FB}}) \cdot C_{\text{FB}}}{s \cdot R_{\text{TOP}} \cdot C_{\text{INT}} \cdot (1 + s \cdot R_{\text{FB}} \cdot C_{\text{FB}})} \quad (\text{EQ. 15})$$



FIGURE 27. COMPENSATION REFERENCE CIRCUIT

The LC output filter has a double pole at its resonant frequency that causes rapid phase change. The R^3 modulator used in the ISL62391, ISL62392, ISL62391C and ISL62392C make the LC output filter resemble a first order system in which the closed loop stability can be achieved with the recommended Type-II compensation network. Intersil provides a PC-based tool (example page is shown later) that can be used to calculate compensation network component values and help simulate the loop frequency response.

3.3V Linear Regulator

In addition to the two SMPS outputs, the ISL62391, ISL62392, ISL62391C and ISL62392C also provide a fixed 3.3V LDO output (LDO3) capable of sourcing 100mA continuous current. LDO3 draws its power from PVCC and can be independently enabled from both SMPS channels.

LDO3 also has a current limit feature with a nominal level of 180mA. Currents in excess of the limit will cause the LDO3 voltage to drop dramatically, limiting the power dissipation.

Thermal Monitor and Protection

LDO3 and PVCC LDOs can dissipate non-trivial power inside the ISL62391, ISL62392, ISL62391C and ISL62392C at high input-to-output voltage ratios and full load conditions. To protect the silicon, ISL62391, ISL62392, ISL62391C and ISL62392C continually monitor the die temperature. If the temperature exceeds +150°C, all outputs will be turned off to sharply curtail

power dissipation. The outputs will remain off until the junction temperature has fallen below +135°C.

General Application Design Guide

This design guide is intended to provide a high-level explanation of the steps necessary to design a single-phase power converter. It is assumed that the reader is familiar with many of the basic skills and techniques referenced in the following section. In addition to this guide, Intersil provides complete reference designs that include schematics, bills of materials, and example board layouts.

Selecting the LC Output Filter

The duty cycle of an ideal buck converter is a function of the input and the output voltage. This relationship is written as Equation 16:

$$D = \frac{V_{\text{O}}}{V_{\text{IN}}} \quad (\text{EQ. 16})$$

The output inductor peak-to-peak ripple current is written as Equation 17:

$$I_{\text{PP}} = \frac{V_{\text{O}} \cdot (1 - D)}{f_{\text{SW}} \cdot L} \quad (\text{EQ. 17})$$

A typical step-down DC/DC converter will have an $I_{\text{P,P}}$ of 20% to 40% of the maximum DC output load current. The value of $I_{\text{P,P}}$ is selected based upon several criteria, such as MOSFET switching loss, inductor core loss, and the resistive loss of the inductor winding. The DC copper loss of the inductor can be estimated by Equation 18:

$$P_{\text{COPPER}} = I_{\text{LOAD}}^2 \cdot \text{DCR} \quad (\text{EQ. 18})$$

Where I_{LOAD} is the converter output DC current.

The copper loss can be significant so attention has to be given to the DCR selection. Another factor to consider when choosing the inductor is its saturation characteristics at elevated temperature. A saturated inductor could cause destruction of circuit components, as well as nuisance OCP faults.

A DC/DC buck regulator must have output capacitance C_{O} into which ripple current $I_{\text{P,P}}$ can flow. Current $I_{\text{P,P}}$ develops a corresponding ripple voltage $V_{\text{P,P}}$ across C_{O} , which is the sum of the voltage drop across the capacitor ESR and of the voltage change stemming from charge moved in and out of the capacitor. These two voltages are written as Equation 19:

$$\Delta V_{\text{ESR}} = I_{\text{P,P}} \cdot \text{ESR} \quad (\text{EQ. 19})$$

and Equation 20:

$$\Delta V_{\text{C}} = \frac{I_{\text{P,P}}}{8 \cdot C_{\text{O}} \cdot f_{\text{SW}}} \quad (\text{EQ. 20})$$

If the output of the converter has to support a load with high pulsating current, several capacitors will need to be paralleled to reduce the total ESR until the required $V_{\text{P,P}}$ is achieved. The inductance of the capacitor can cause a brief voltage dip if the

load transient has an extremely high slew rate. Low inductance capacitors should be considered in this scenario. A capacitor dissipates heat as a function of RMS current and frequency. Be sure that I_{P-P} is shared by a sufficient quantity of paralleled capacitors so that they operate below the maximum rated RMS current at f_{SW} . Take into account that the rated value of a capacitor can fade as much as 50% as the DC voltage across it increases.

Selection of the Input Capacitor

The important parameters for the bulk input capacitance are the voltage rating and the RMS current rating. For reliable operation, select bulk capacitors with voltage and current ratings above the maximum input voltage and capable of supplying the RMS current required by the switching circuit. Their voltage rating should be at least 1.25x greater than the maximum input voltage, while a voltage rating of 1.5x is a preferred rating. Figure 28 is a graph of the input RMS ripple current (normalized relative to output load current) as a function of duty cycle and is adjusted for a converter efficiency of 80%. The ripple current calculation is written as Equation 21:

$$I_{IN_RMS,NORMALIZED} = \sqrt{(D - D^2) + \left(D \cdot \frac{x^2}{12}\right)} \quad (EQ. 21)$$

Where:

- I_{MAX} is the maximum continuous I_{LOAD} of the converter
- x is a multiplier (0 to 1) corresponding to the inductor peak-to-peak ripple amplitude expressed as a percentage of I_{MAX} (0% to 100%)
- D is the duty cycle that is adjusted to take into account the efficiency of the converter which is written as Equation 22.

$$D = \frac{V_O}{V_{IN} \cdot EFF} \quad (EQ. 22)$$

In addition to the bulk capacitance, some low ESL ceramic capacitance is recommended to decouple between the drain of the high-side MOSFET and the source of the low-side MOSFET.



FIGURE 28. NORMALIZED RMS INPUT CURRENT

MOSFET Selection and Considerations

Typically, a MOSFET cannot tolerate even brief excursions beyond their maximum drain to source voltage rating. The MOSFETs used in the power stage of the converter should have a maximum V_{DS} rating that exceeds the sum of the upper voltage tolerance of the input power source and the voltage spike that occurs when the MOSFET switches off.

There are several power MOSFETs readily available that are optimized for DC/DC converter applications. The preferred high-side MOSFET emphasizes low gate charge so that the device spends the least amount of time dissipating power in the linear region. Unlike the low-side MOSFET, which has the drain-source voltage clamped by its body diode during turn off, the high-side MOSFET turns off with a V_{DS} of approximately $V_{IN} - V_{OUT}$, plus the spike across it. The preferred low-side MOSFET emphasizes low $r_{DS(ON)}$ when fully saturated to minimize conduction loss. It should be noted that this is an optimal configuration of MOSFET selection for low duty cycle applications ($D < 50\%$). For higher output, low input voltage solutions, a more balanced MOSFET selection for high- and low-side devices may be warranted.

For the low-side (LS) MOSFET, the power loss can be assumed to be conductive only and is written as Equation 23:

$$P_{CON_LS} \approx I_{LOAD}^2 \cdot r_{DS(ON)_LS} \cdot (1 - D) \quad (EQ. 23)$$

For the high-side (HS) MOSFET, the conduction loss is written as Equation 24:

$$P_{CON_HS} = I_{LOAD}^2 \cdot r_{DS(ON)_HS} \cdot D \quad (EQ. 24)$$

For the high-side MOSFET, the switching loss is written as Equation 25:

$$P_{SW_HS} = \frac{V_{IN} \cdot I_{VALLEY} \cdot t_{ON} \cdot f_{SW}}{2} + \frac{V_{IN} \cdot I_{PEAK} \cdot t_{OFF} \cdot f_{SW}}{2} \quad (EQ. 25)$$

Where:

- I_{VALLEY} is the difference of the DC component of the inductor current minus 1/2 of the inductor ripple current
- I_{PEAK} is the sum of the DC component of the inductor current plus 1/2 of the inductor ripple current
- t_{ON} is the time required to drive the device into saturation
- t_{OFF} is the time required to drive the device into cut-off

Selecting The Bootstrap Capacitor

The selection of the bootstrap capacitor is written as Equation 26:

$$C_{BOOT} = \frac{Q_g}{\Delta V_{BOOT}} \quad (EQ. 26)$$

Where:

- Q_g is the total gate charge required to turn on the high-side MOSFET
- ΔV_{BOOT} is the maximum allowed voltage decay across the boot capacitor each time the high-side MOSFET is switched on

As an example, suppose the high-side MOSFET has a total gate charge Q_g of 25nC at $V_{GS} = 5V$, and a ΔV_{BOOT} of 200mV. The calculated bootstrap capacitance is 0.125 μF ; for a comfortable margin, select a capacitor that is double the calculated capacitance. In this example, 0.22 μF will suffice. Use an X7R or X5R ceramic capacitor.

Layout Considerations

As a general rule, power should be on the bottom layer of the PCB and weak analog or logic signals are on the top layer of the PCB. The ground-plane layer should be adjacent to the top layer to provide shielding. The ground plane layer should have an island located under the IC, the compensation components, and the FSET components. The island should be connected to the rest of the ground plane layer at one point.

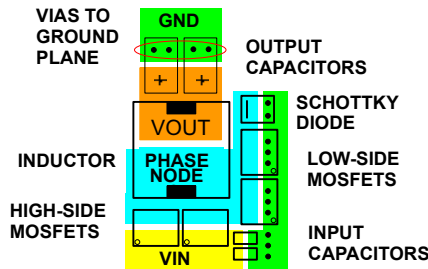

FIGURE 29. TYPICAL POWER COMPONENT PLACEMENT

Because there are two SMPS outputs and only one PGND pin, the power train of both channels should be laid out symmetrically. The line of bilateral symmetry should be drawn through pins 4 and 18. This layout approach ensures that the controller does not favor one channel over another during critical switching decisions. Figure 29 illustrates one example of how to achieve proper bilateral symmetry.

Signal Ground and Power Ground

The bottom of the ISL62391, ISL62392, ISL62391C and ISL62392C TQFN package is the signal ground (GND) terminal for analog and logic signals of the IC. Connect the GND pad of the ISL62391, ISL62392, ISL62391C and ISL62392C to the island of ground plane under the top layer using several vias for a robust thermal and electrical conduction path. Connect the input capacitors, the output capacitors, and the source of the lower MOSFETs to the power ground plane.

PGND (Pin 19)

This is the return path for the pull-down of the LGATE low-side MOSFET gate driver. Ideally, PGND should be connected to the source of the low-side MOSFET with a low-resistance, low-inductance path.

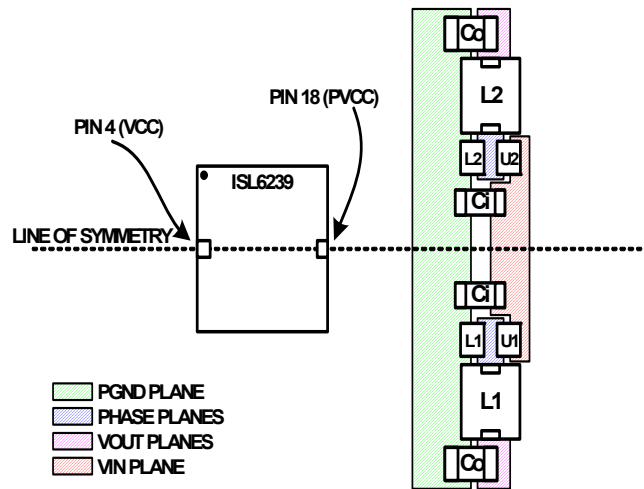

FIGURE 30. SYMMETRIC LAYOUT GUIDE

VIN (Pin 17)

The VIN pin should be connected close to the drain of the high-side MOSFET, using a low resistance and low inductance path.

VCC (Pin 4)

For best performance, place the decoupling capacitor very close to the VCC and GND pins.

PVCC (Pin 18)

For best performance, place the decoupling capacitor very close to the PVCC and respective PGND pin, preferably on the same side of the PCB as the ISL62391, ISL62392, ISL62391C and ISL62392C ICs.

EN (Pins 11 and 24), and PGOOD (Pin 1)

These are logic signals that are referenced to the GND pin. Treat as a typical logic signal.

OCSET (Pins 10 and 25) and ISEN (Pins 9 and 26)

For DCR current sensing, the current-sense network, consisting of R_{OCSET} and C_{SEN} , needs to be connected to the inductor pads for accurate measurement. Connect R_{OCSET} to the phase-node side pad of the inductor, and connect C_{SEN} to the output side pad of the inductor. The ISEN resistor should also be connected to the output pad of the inductor with a separate trace. Connect the OCSET pin to the common node of node of R_{OCSET} and C_{SEN} .

For resistive current sensing, connect R_{OCSET} from the OCSET pin to the inductor side of the resistor pad. The ISEN resistor should be connected to the V_{OUT} side of the resistor pad.

In both current-sense configurations, the resistor and capacitor sensing elements, with the exclusion of the current sense power resistor, should be placed near the corresponding IC pin. The trace connections to the inductor or sensing resistor should be treated as Kelvin connections.

FB (Pins 7 and 28), and VOUT (Pins 8 and 27)

The VOUT pin is used to generate the R^3 synthetic ramp voltage and for soft-discharge of the output voltage during shutdown events. This signal should be routed as close to the regulation point as possible. The input impedance of the FB pin is high, so place the voltage programming and loop compensation components close to the VOUT, FB, and GND pins, keeping the high impedance trace short.

FSET (Pins 2 and 6)

This pin requires a quiet environment. The resistor R_{FSET} and capacitor C_{FSET} should be placed directly adjacent to this pin. Keep fast moving nodes away from this pin.

LGATE (Pins 15 and 20)

The signal going through this trace is both high dv/dt and high di/dt, with high peak charging and discharging current. Route this trace in parallel with the trace from the PGND pin. These two traces should be short, wide, and away from other traces. There should be no other weak signal traces in proximity with these traces on any layer.

BOOT (Pins 14 and 21), UGATE (Pins 13 and 22), and PHASE (Pins 12 and 23)

The signals going through these traces are both high dv/dt and high di/dt, with high peak charging and discharging current. Route the UGATE and PHASE pins in parallel with short and wide traces. There should be no other weak signal traces in proximity with these traces on any layer.

Copper Size for the Phase Node

The parasitic capacitance and parasitic inductance of the phase node should be kept very low to minimize ringing. It is best to limit the size of the PHASE node copper in strict accordance with the current and thermal management of the application. An MLCC should be connected directly across the drain of the upper MOSFET and the source of the lower MOSFET to suppress the turn-off voltage spike.

Revision History

The revision history provided is for informational purposes only and is believed to be accurate, but not warranted. Please go to the web to make sure that you have the latest revision.

DATE	REVISION	CHANGE
August 25, 2015	FN6666.8	Updated Ordering Information table on page 2. Added Revision History and About Intersil sections. Updated Package Outline Drawing L28.4X4 to the latest revision. -Revision 0 to Revision 1 changes - Added +/- 0.05 tolerances to each dimension in Top View and Bottom View. Added 2 degrees to Bottom view pin 1 index area dimension

About Intersil

Intersil Corporation is a leading provider of innovative power management and precision analog solutions. The company's products address some of the largest markets within the industrial and infrastructure, mobile computing and high-end consumer markets.

For the most updated datasheet, application notes, related documentation and related parts, please see the respective product information page found at www.intersil.com.

You may report errors or suggestions for improving this datasheet by visiting www.intersil.com/ask.

Reliability reports are also available from our website at www.intersil.com/support.

© Copyright Intersil Americas LLC 2008-2015. All Rights Reserved.
All trademarks and registered trademarks are the property of their respective owners.

For additional products, see www.intersil.com/en/products.html

Intersil products are manufactured, assembled and tested utilizing ISO9001 quality systems as noted in the quality certifications found at www.intersil.com/en/support/qualandreliability.html

Intersil products are sold by description only. Intersil may modify the circuit design and/or specifications of products at any time without notice, provided that such modification does not, in Intersil's sole judgment, affect the form, fit or function of the product. Accordingly, the reader is cautioned to verify that datasheets are current before placing orders. Information furnished by Intersil is believed to be accurate and reliable. However, no responsibility is assumed by Intersil or its subsidiaries for its use; nor for any infringements of patents or other rights of third parties which may result from its use. No license is granted by implication or otherwise under any patent or patent rights of Intersil or its subsidiaries.

For information regarding Intersil Corporation and its products, see www.intersil.com

Package Outline Drawing

L28.4x4

28 LEAD THIN QUAD FLAT NO-LEAD PLASTIC PACKAGE

Rev 1, 6/15

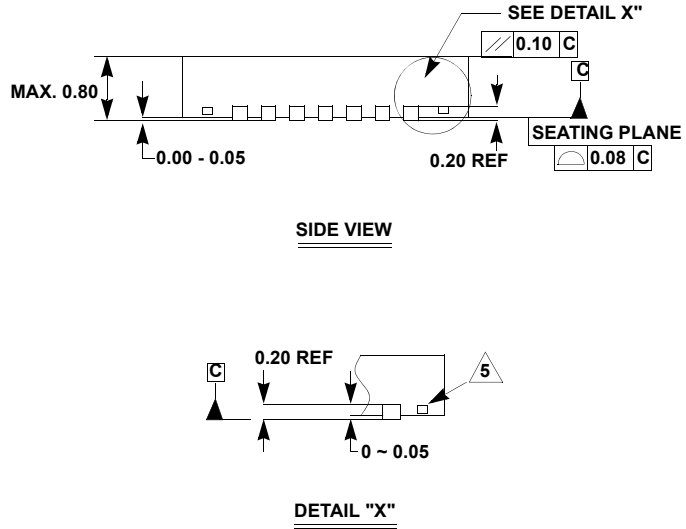
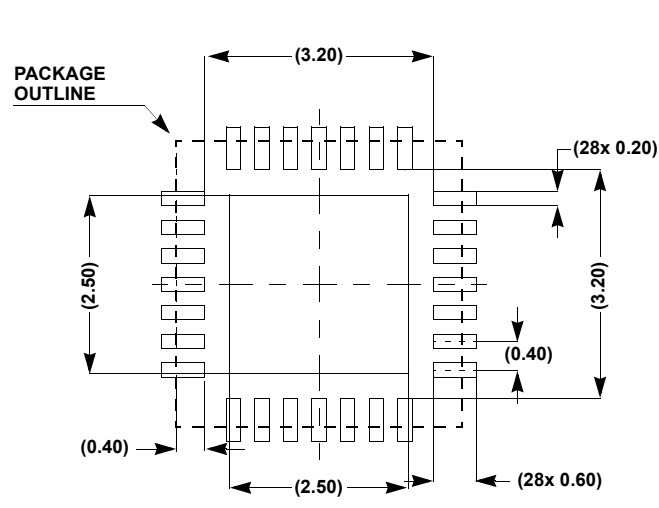
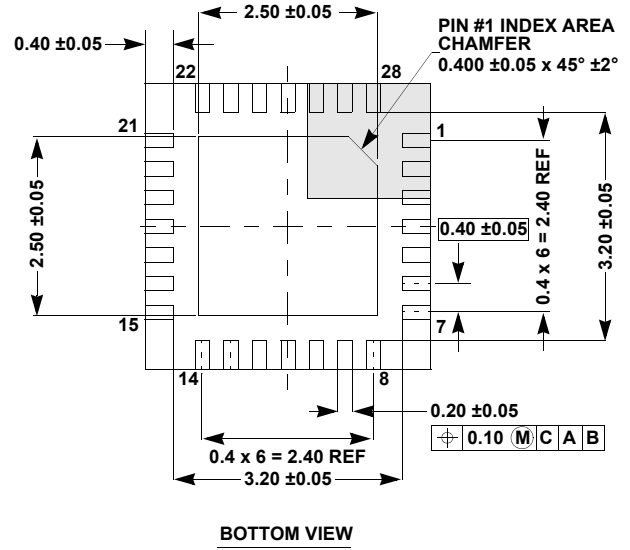
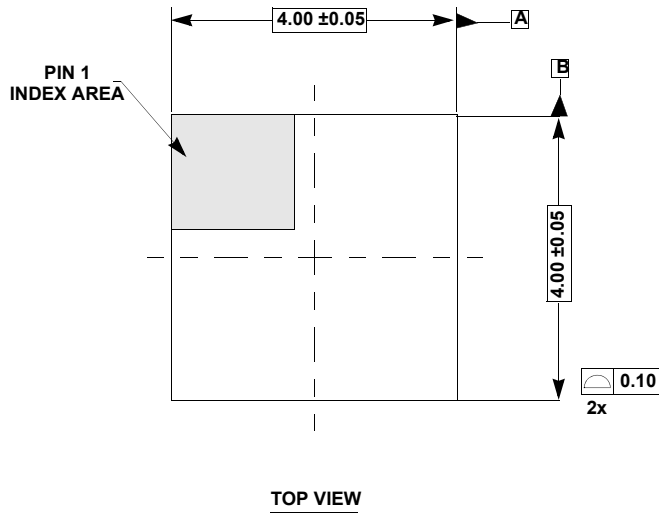

- NOTES:
- Controlling dimensions are in mm.
Dimensions in () are for reference only.
 - Unless otherwise specified, tolerance : Decimal ±0.05
Angular ±2°
 - Dimensioning and tolerancing conform to AMSE Y14.5M-1994.
 - Bottom side Pin#1 ID is diepad chamfer as shown.
 - Tiebar shown (if present) is a non-functional feature.