



## 1785MHz-1880MHz, 180W, 28V High Power RF LDMOS FETs

### Description

The ITCH18180B4 is a 180-watt, internally matched LDMOS FET, designed for multicarrier WCDMA/PCS/DCS/LTE base station and ISM applications with frequencies from 1785 to 1880 MHz. It Can be used in Class AB/B and Class C for all typical cellular base station modulation formats.

•Typical Performance of Doherty Demo (On Innegration fixture with device soldered):

$V_{DD} = 28$  Volts,  $I_{DQMAIN} = 450$  mA,  $V_{GPEAK} = 0.8$ V, Pulse CW, Pulse Width=20 us, Duty cycle=10% .

Freq (MHz)	P <sub>-1dB</sub> (dBm)	P <sub>-3dB</sub> (dBm)	$\eta_D @ P_{-3}$ (%)	P <sub>avg</sub> =45dBm WCDMA Signal <sup>(1)</sup>		
				Gp (dB)	$\eta_D$ (%)	ACPR <sub>5M</sub> (dBc)
1785	51.0	52.6	58.7	14.6	44.2	-27.0
1795	51.3	52.7	59.8	14.7	44.2	-27.4
1805	51.1	52.6	59.8	14.8	44.4	-27.4

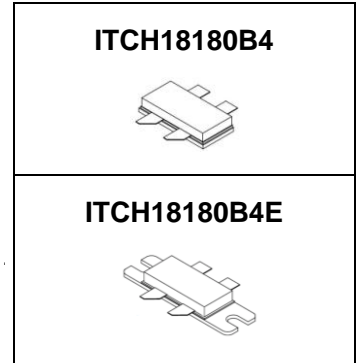

•Typical Performance of Doherty Demo (On Innegration fixture with device soldered):

$V_{DD} = 28$  Volts,  $I_{DQMAIN} = 600$  mA,  $V_{GPEAK} = 0.9$ V, Pulse CW, Pulse Width=20 us, Duty cycle=10% .

Freq (MHz)	P <sub>-1dB</sub> (dBm)	P <sub>-3dB</sub> (dBm)	$\eta_D @ P_{-3}$ (%)	P <sub>avg</sub> =45dBm WCDMA Signal <sup>(1)</sup>		
				Gp (dB)	$\eta_D$ (%)	ACPR <sub>5M</sub> (dBc)
1805	51.2	53.2	57.4	15.6	42.0	-29.8
1842.5	51.4	53.3	57.7	15.5	41.6	-31.8
1880	51.0	52.9	57.5	15.3	41.7	-32.7

Note(1) WCDMA signal: 3GPP test model 1; 1 to 64 DPCH; Channel Bandwidth=3.84MHz, PAR =10.5 dB at 0.01 % probability on CCDF.

### Features

- High Efficiency and Linear Gain Operations
- Integrated ESD Protection
- Internally Matched for Ease of Use
- Excellent thermal stability, low HCI drift
- Large Positive and Negative Gate/Source Voltage Range for Improved Class C Operation
- Pb-free, RoHS-compliant

**Table 1. Maximum Ratings**

Rating	Symbol	Value	Unit
Drain--Source Voltage	$V_{DSS}$	70	Vdc
Gate--Source Voltage	$V_{GS}$	-10 to +10	Vdc
Operating Voltage	$V_{DD}$	+32	Vdc
Storage Temperature Range	$T_{stg}$	-65 to +150	°C
Case Operating Temperature	$T_c$	+150	°C
Operating Junction Temperature	$T_j$	+225	°C

**Table 2. Thermal Characteristics**

Characteristic	Symbol	Value	Unit
----------------	--------	-------	------



Thermal Resistance, Junction to Case $T_C=85^{\circ}\text{C}, T_J=200^{\circ}\text{C}, \text{DC test}$	$R_{\theta JC}$	0.38	$^{\circ}\text{C/W}$
---	-----------------	------	----------------------

**Table 3. ESD Protection Characteristics**

Test Methodology	Class
Human Body Model (per JESD22--A114)	Class 2

**Table 4. Electrical Characteristics** (TA = 25°C unless otherwise noted)

Characteristic	Symbol	Min	Typ	Max	Unit
----------------	--------	-----	-----	-----	------

**DC Characteristics (per Section)**

Drain-Source Breakdown Voltage ( $V_{GS}=0\text{V}; I_D=1\text{mA}$ )	$V_{DSS}$	65	70		V
Zero Gate Voltage Drain Leakage Current ( $V_{DS} = 28\text{ V}, V_{GS} = 0\text{ V}$ )	$I_{DSS}$			10	$\mu\text{A}$
Gate--Source Leakage Current ( $V_{GS} = 10\text{ V}, V_{DS} = 0\text{ V}$ )	$I_{GSS}$			1	$\mu\text{A}$
Gate Threshold Voltage ( $V_{DS} = 28\text{V}, I_D = 600\text{ uA}$ )	$V_{GS(th)}$		1.8		V
Gate Quiescent Voltage ( $V_{DD} = 28\text{ V}, I_{DQ} = 800\text{ mA}, \text{Measured in Functional Test}$ )	$V_{GS(Q)}$	2.2	2.7	3.2	V

**Functional Tests (On Innogrator doherty demo, 50 ohm system)** :  $V_{DD} = 28\text{ Vdc}, I_{DQMAIN} = 600\text{ mA}, V_{GPEAK} = 0.9\text{V}, f = 1880\text{ MHz}, \text{Pulse CW}, \text{Pulse Width} = 20\text{ us}, \text{Duty cycle} = 10\%$ .

Power Gain @ 30W Output	$G_p$		15.3		dB
1 dB Compression Point	$P_{-1dB}$		51.0		dBm
3dB Compression Point	$P_{-3dB}$		52.9		dBm
Drain Efficiency@P3dB	$\eta_D$		57.5		%
Input Return Loss	IRL		-7		dB

**Load Mismatch (On Innogrator Test Fixture, 50 ohm system)**:  $V_{DD} = 28\text{ Vdc}, I_{DQ} = 800\text{ mA}, f = 1880\text{ MHz}$

VSWR 10:1 at 180W pulse CW Output Power	No Device Degradation
---	-----------------------

## TYPICAL CHARACTERISTICS

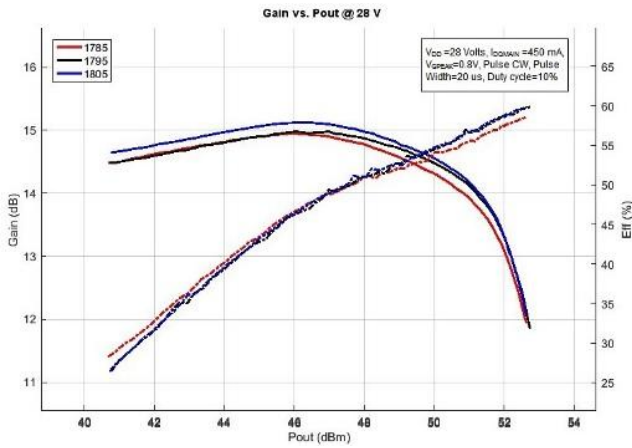

Figure 1. Power gain and drain efficiency as function of Pulse output power(Doherty Circuit 1785-1805MHz)

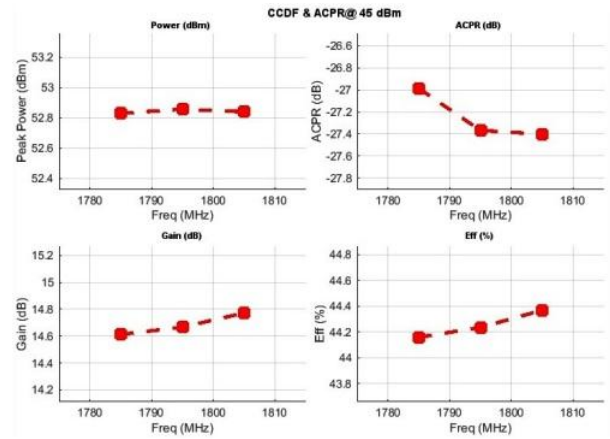

Figure 2. Single-Carrier WCDMA CCDF and ACPR<sub>5MHz</sub> @ 30W as function frequency(Doherty Circuit 1785-1805MHz)

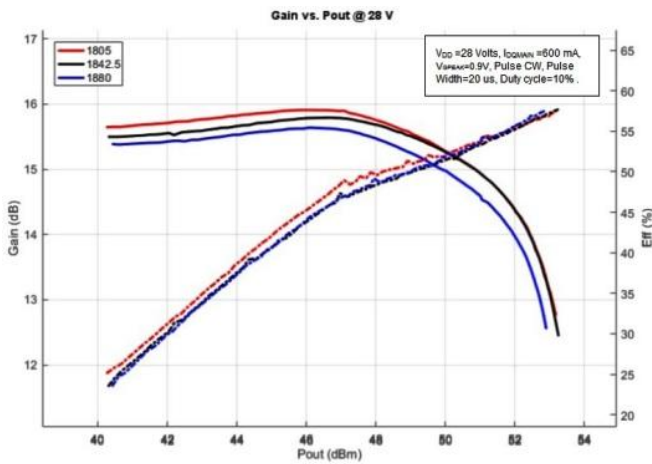

Figure 3. Power gain and drain efficiency as function of Pulse output power(Doherty Circuit 1805-1880MHz)

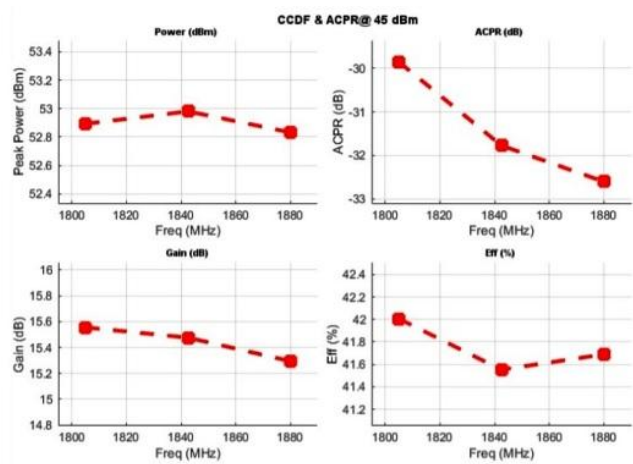
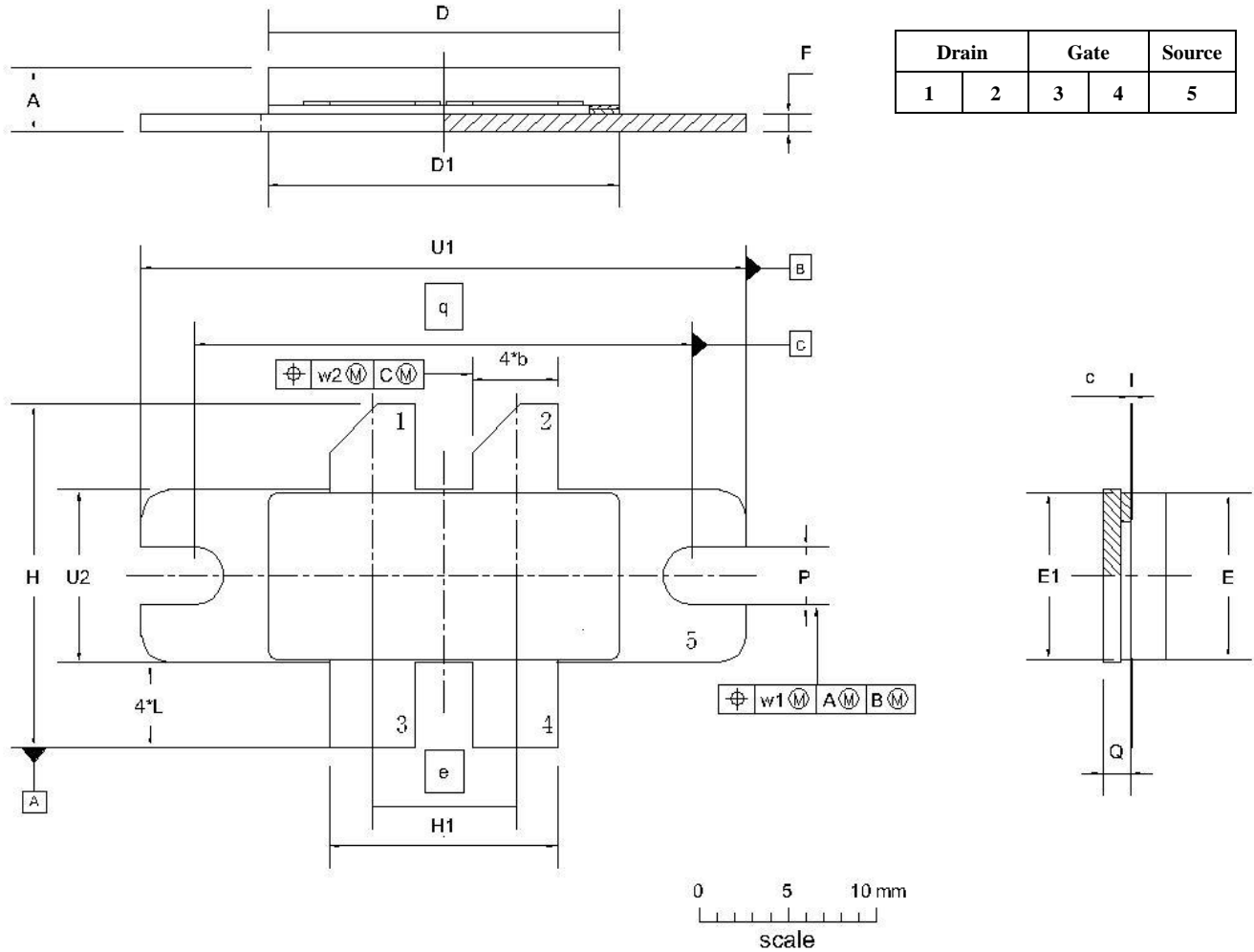

Figure 4. Single-Carrier WCDMA CCDF and ACPR<sub>5MHz</sub> @ 30W as function frequency(Doherty Circuit 1805-1880MHz)



## Package Outline

Eared Flanged Ceramic Package; 2 mounting holes; 4 leads



UNIT	A	b	c	D	D <sub>1</sub>	e	E	E <sub>1</sub>	F	H	H <sub>1</sub>	L	p	Q	q	U <sub>1</sub>	U <sub>2</sub>	W <sub>1</sub>	W <sub>2</sub>
mm	4.72	4.67	0.15	20.02	19.96	7.90	9.50	9.53	1.14	19.94	12.98	5.33	3.38	1.70	27.94	34.16	9.91	0.25	0.51
	3.43	4.93	0.08	19.61	19.66		9.30	9.25	0.89	18.92	12.73	4.32	3.12	1.45		33.91	9.65		
inches	0.186	0.194	0.006	0.788	0.786	0.311	0.374	0.375	0.045	0.785	0.511	0.210	0.133	0.067	1.100	1.345	0.390	0.01	0.02
	0.135	0.184	0.003	0.772	0.774		0.366	0.364	0.035	0.745	0.501	0.170	0.123	0.057		1.335	0.380		

OUTLINE VERSION	REFERENCE			EUROPEAN PROJECTION	ISSUE DATE
	IEC	JEDEC	JEITA		
PKG-B4E					03/12/2013



Earless Flanged Ceramic Package; 4 leads

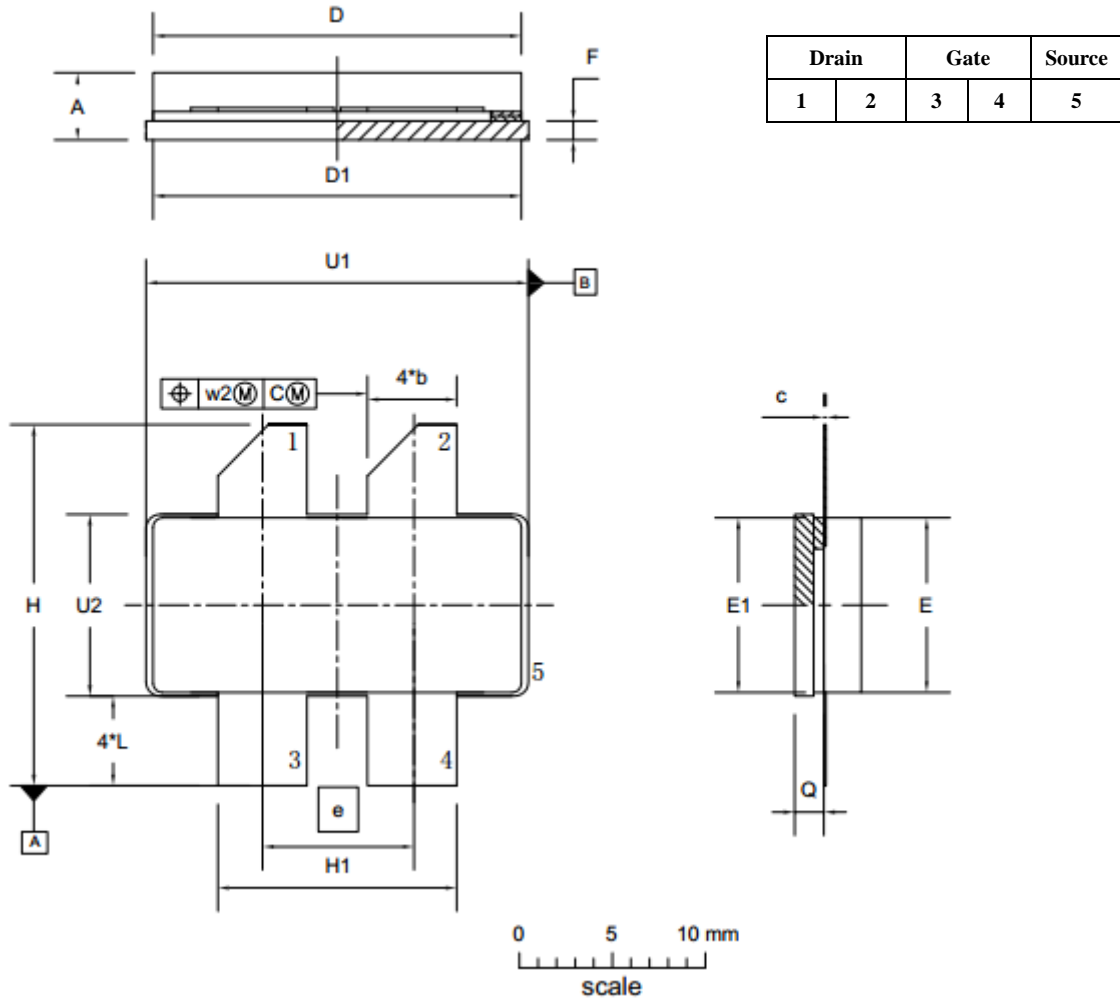

UNIT	A	b	c	D	D <sub>1</sub>	e	E	E <sub>1</sub>	F	H	H <sub>1</sub>	L	Q	U <sub>1</sub>	U <sub>2</sub>	W <sub>1</sub>	W <sub>2</sub>
mm	4.72	4.67	0.15	20.02	19.96	7.90	9.50	9.53	1.14	19.94	12.98	5.33	1.70	20.70	9.91	0.25	0.51
	3.43	4.93	0.08	19.61	19.66		9.30	9.25	0.89	18.92	12.73	4.32	1.45	20.45	9.65		
inches	0.186	0.194	0.006	0.788	0.786	0.311	0.374	0.375	0.045	0.785	0.511	0.210	0.067	0.815	0.390	0.01	0.02
	0.135	0.184	0.003	0.772	0.774		0.366	0.364	0.035	0.745	0.501	0.170	0.057	0.805	0.380		

OUTLINE VERSION	REFERENCE			EUROPEAN PROJECTION	ISSUE DATE
	IEC	JEDEC	JEITA		
PKG-B4					03/12/2013



## Revision history

Table 5. Document revision history

Date	Revision	Datasheet Status
2017/09/07	Rev 1.0	Preliminary Datasheet

## Disclaimers

Specifications are subject to change without notice. Innogrations believes the information contained within this data sheet to be accurate and reliable. However, no responsibility is assumed by Innogrations for any infringement of patents or other rights of third parties which may result from its use. No license is granted by implication or otherwise under any patent or patent rights of Innogrations. Innogrations makes no warranty, representation or guarantee regarding the suitability of its products for any particular purpose. "Typical" parameters are the average values expected by Innogrations in large quantities and are provided for information purposes only. These values can and do vary in different applications and actual performance can vary over time. All operating parameters should be validated by customer's technical experts for each application. Innogrations products are not designed, intended or authorized for use as components in applications intended for surgical implant into the body or to support or sustain life, in applications in which the failure of the Innogrations product could result in personal injury or death or in applications for planning, construction, maintenance or direct operation of a nuclear facility. For any concerns or questions related to terms or conditions, pls check with Innogrations and authorized distributors  
Copyright © by Innogrations (Suzhou) Co.,Ltd.