



# Technical Data Sheet

## Opto Interrupter

---

### ITR8307/F43

#### ■ Features

- Fast response time
- High sensitivity
- Cut-Off visible wavelength
- Thin
- Compact
- Pb free
- This product itself will remain within RoHS compliant version.

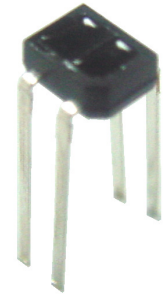

#### ■ Descriptions

ITR8307/F43 is a light reflection switch which includes a GaAs IR-LED transmitter and a NPN photo-transistor with a high sensitive receiver for short distance, operating in the infrared range. Both components are mounted side- by- side in a plastic package.

#### ■ Applications

- Camera
- VCR
- Floppy disk driver
- Cassette type recorder
- Various microcomputer control equipment

#### ■ Device Selection Guide

Device No.	Chip Material
IR	GaAs
PT	Silicon

**Package Dimensions**

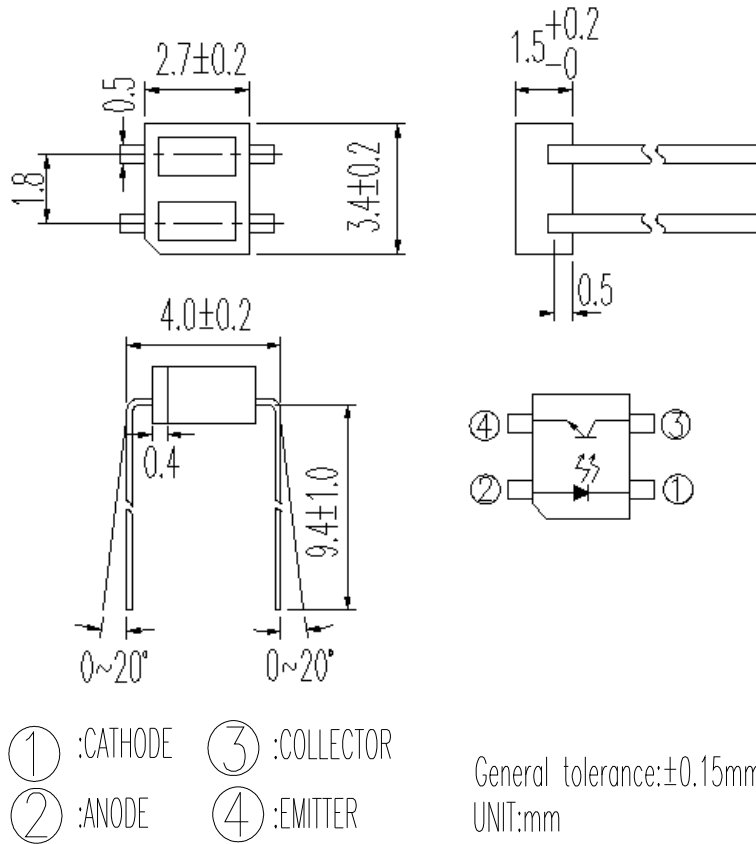

**Absolute Maximum Ratings (Ta=25°C)**

Parameter		Symbol	Ratings	Unit
Input	Power Dissipation at(or below) 25°C Free Air Temperature	Pd	75	mW
	Reverse Voltage	V <sub>R</sub>	5	V
	Forward Current	I <sub>F</sub>	50	mA
	Peak Forward Current (*1)	I <sub>FP</sub>	1	A
Output	Collector Power Dissipation	P <sub>C</sub>	75	mW
	Collector Current	I <sub>C</sub>	50	mA
	Collector-Emitter Voltage	B V <sub>CEO</sub>	30	V
	Emitter-Collector Voltage	B V <sub>ECO</sub>	5	V
Operating Temperature		Topr	-25~+85	°C
Storage Temperature		Tstg	-30~+100	°C
Lead Soldering Temperature (*2)		Tsol	260	°C

(\* 1) tw=100μsec. , T=10 msec.

(\* 2) t=5 Sec

**Electro-Optical Characteristics (Ta=25°C)**

Parameter		Symbol	Min.	Typ.	Max.	Unit	Conditions
Input	Forward Voltage	$V_F$	--	1.2	1.6	V	$I_F=20\text{mA}$
	Reverse Current	$I_R$	--	--	10	$\mu\text{A}$	$V_R=6\text{V}$
	Peak Wavelength	$\lambda_P$	--	940	--	nm	$I_F=20\text{mA}$
Output	Dark Current	$I_{CEO}$	--	--	100	nA	$V_{CE}=10\text{V}$ , $I_F=0\text{mA}$
Transfer Characteristics	Collector Current	$I_{C(ON)}$	0.1	--	--	mA	$V_{CE}=5\text{V}$ , $I_F=20\text{mA}$
	Leakage Current	$I_{CEOD}$	--	--	1	$\mu\text{A}$	$V_{CE}=5\text{V}$ , $I_F=20\text{mA}$
	Rise time	tr	--	20	--	$\mu\text{s}$	$V_{CE}=2\text{V}$ $I_C=0.1\text{mA}$
	Fall time	tf	--	20	--	$\mu\text{s}$	$R_L=1\text{K}\Omega$ , d=1mm

**Typical Electrical/Optical/Characteristics Curves for IR**

Fig. 1 Forward Current vs. Ambient Temperature

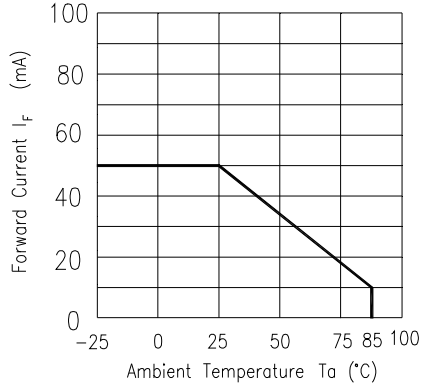

Fig. 2 Spectral Distribution

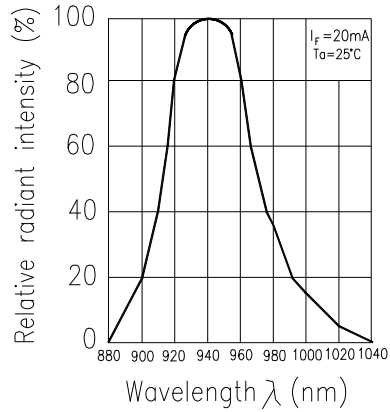

Fig. 3 Peak Emission Wavelength vs. Ambient Temperature

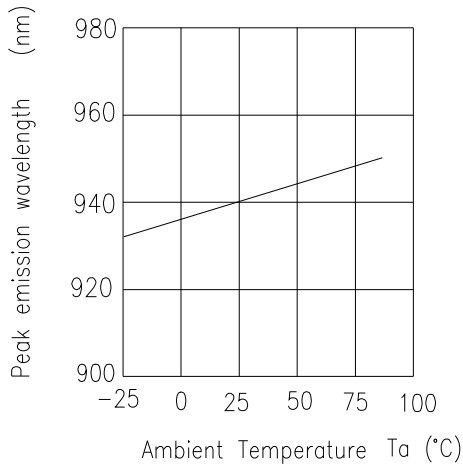

Fig. 4 Forward Current vs. Forward Voltage

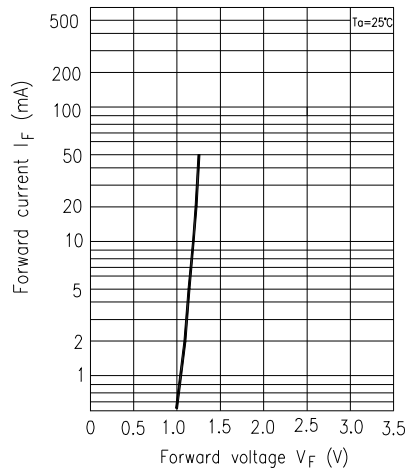

Fig. 5 Forward Voltage vs. Ambient Temperature

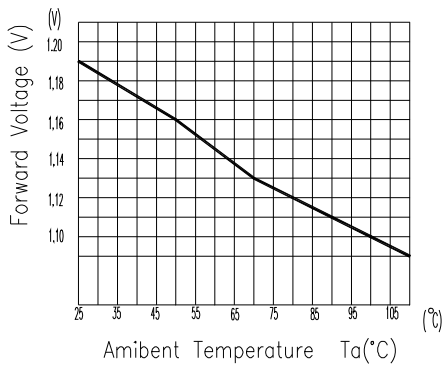
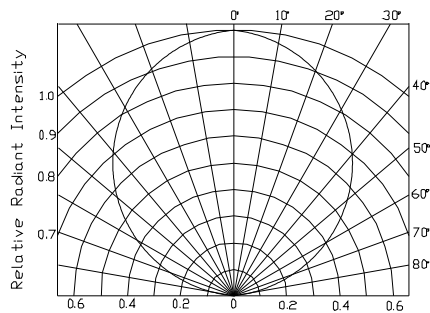

Fig. 6 Relative Radiant Intensity vs. Angular Displacement



**Typical Electrical/Optical/Characteristics Curves for PT**

Fig.1 Collector Power Dissipation vs. Ambient Temperature

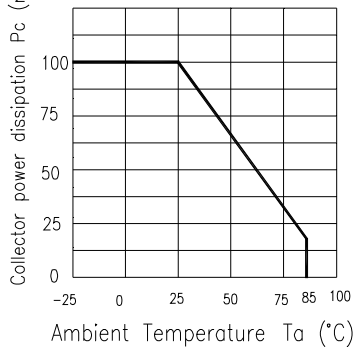

Fig.2 Collector Dark Current vs. Ambient Temperature

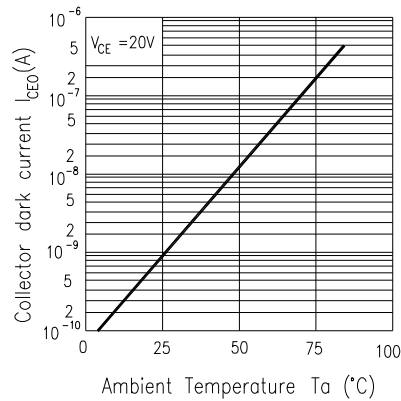

Fig. 3 Relative Collector Current vs. Ambient Temperature

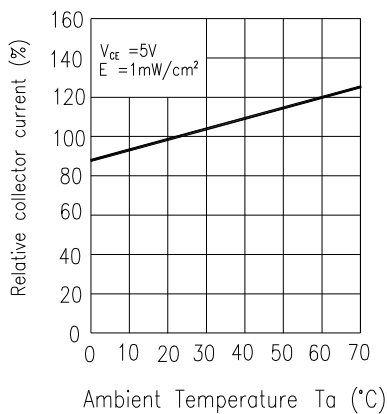

Fig.4 Collector Current vs. Irradiance

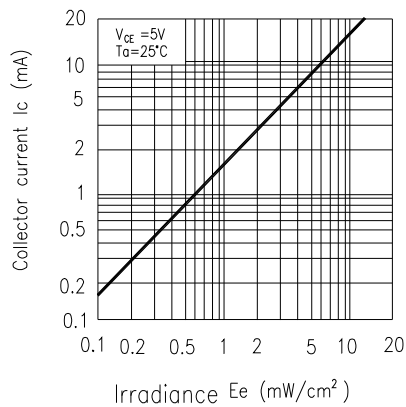

Fig.5 Spectral Sensitivity

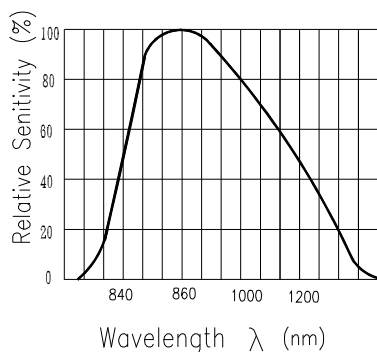
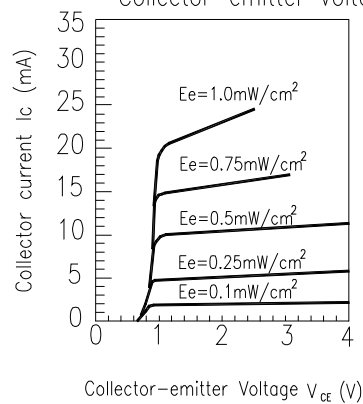

Fig.6 Collector Current vs. Collector-emitter Voltage



**Typical Electrical/Optical/Characteristics Curves for ITR**

Fig.1 Relative Collector Current vs. Distance between Sensor and Al Evaporation Galss

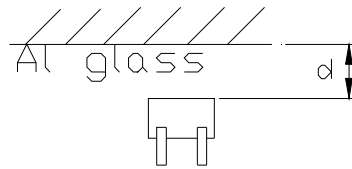
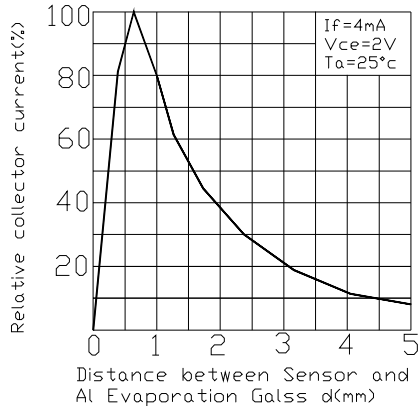

Fig.2 Relative Collector Current vs. Card Moving Distance (l)

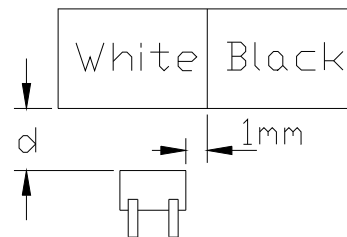
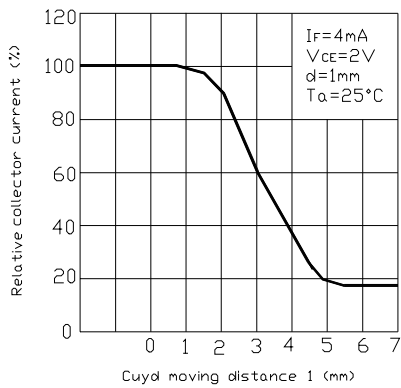
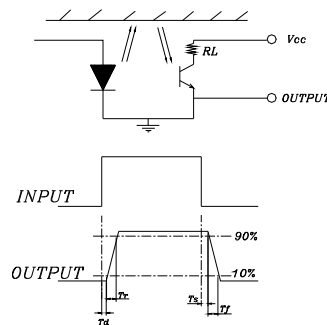
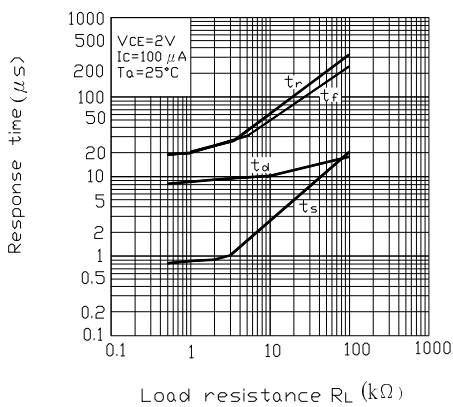

Fig.3 Response Time vs. Load Resistance



**Reliability Test Item And Condition**

The reliability of products shall be satisfied with items listed below.

Confidence level : 90% LTPD : 10%

NO.	Item	Test Conditions	Test Hours/ Cycles	Sample Sizes	Failure Judgement Criteria	Ac/Re
1	Solder Heat	TEMP. : 260°C±5°C	10secs	22pcs	$I_R \geq U \times 2$ $E_e \leq L \times 0.8$ $V_F \geq U \times 1.2$  U : Upper Specification  Limit L : Lower Specification Limit	0/1
2	Temperature Cycle	H : +85°C      30mins ↑ 5mins ↓ L : -55°C      30mins	50Cycles	22pcs		0/1
3	Thermal Shock	H : +100°C    5mins ↑ 10secs ↓ L : -10°C      5mins	50Cycles	22pcs		0/1
4	High Temperature Storage	TEMP. : +100°C	1000hrs	22pcs		0/1
5	Low Temperature Storage	TEMP. : -55°C	1000hrs	22pcs		0/1
6	DC Operating Life	$I_F = 20\text{mA}$	1000hrs	22pcs		0/1
7	High Temperature/ High Humidity	85°C / 85% R.H	1000hrs	22pcs		0/1

**■ Packing Quantity Specification**

- 1. 160 Pcs/ Per Tube
- 2. 18 Tubes / Inner Carton
- 3. 12 Inner Cartons / Outside Carton

**■ Label Form Specification**



CPN: Customer's Production Number

P/N : Production Number

QTY: Packing Quantity

CAT: Ranks

HUE: Peak Wavelength

REF: Reference

LOT No: Lot Number

MADE IN TAIWAN: Production Place



## Recommended Method of Storage

The following are general recommendations for moisture sensitive level (MSL) 4 storage and use :

- Shelf life in sealed bag: 12 months at  $< 40\text{ }^{\circ}\text{C}$  and  $< 90\%$  relative humidity (RH)
- After bag is opened, devices that will be subjected to reflow solder or other high temperature process must :
  - a) Mounted within 72 hours of factory conditions  $< 30\text{ }^{\circ}\text{C}/60\%$ RH, or
  - b) Stored at  $<20\%$  RH
- Devices require bake, before mounting, if :
  - Humidity Indicator Card is  $> 20\%$  when read at  $23 \pm 5\text{ }^{\circ}\text{C}$
- If baking is required, devices may be baked :
  - a) 192 hours at  $40\text{ }^{\circ}\text{C}$ , and  $<5\%$  RH(dry air/nitrogen) or
  - b) 96 hours at  $60\text{ }^{\circ}\text{C}$ , and  $<5\%$  RH for all device containers
  - c) 24 hours at  $125\text{ }^{\circ}\text{C}$

## Notes

1. Above specification may be changed without notice. EVERLIGHT will reserve authority on material change for above specification.
2. When using this product, please observe the absolute maximum ratings and the instructions for using outlined in these specification sheets. EVERLIGHT assumes no responsibility for any damage resulting from use of the product which does not comply with the absolute maximum ratings and the instructions included in these specification sheets.
3. These specification sheets include materials protected under copyright of EVERLIGHT corporation. Please don't reproduce or cause anyone to reproduce them without EVERLIGHT's consent.