

**Engineering Specification**

**Type 14.1 XGA Color TFT/LCD Module  
Model Name:ITXG77C**

**Document Control Number : OEM I-77C-02**

**Note:Specification is subject to change without notice. Consequently it is better to contact to International Display Technology before proceeding with the design of your product incorporating this module.**

**Sales Support  
International Display Technology**

## **i Contents**

- i Contents
- ii Record of Revision
- 1.0 Handling Precautions**
- 2.0 General Description**
  - 2.1 Characteristics
  - 2.2 Functional Block Diagram
- 3.0 Absolute Maximum Ratings**
- 4.0 Optical Characteristics**
- 5.0 Signal Interface**
  - 5.1 Connectors
  - 5.2 Signal Pin
  - 5.3 Signal Description
  - 5.4 Signal Electrical Characteristics
  - 5.5 Signal for Lamp connector
- 6.0 Pixel format image**
- 7.0 Parameter guide line for CFL Inverter**
- 8.0 Interface Timings**
  - 8.1 Timing Characteristics
  - 8.2 Timing Definition
- 9.0 Power Consumption**
- 10.0 Power ON/OFF Sequence**
- 11.0 Mechanical Characteristics**
- 12.0 National Test Lab Requirement**

## ii Record of Revision

Date	Document Revision	Page	Summary
August 23,2000	OEM77C-01 (Preliminary)	All	First Preliminary Edition for customer. Lamp Cable Length : 105mm
November 20,2000	OEM77C-02	5 8 11 13,14,15 17 18 19 21 22 23	Based on Internal Specification EC F79300 as of November 14,2000. To update Typical White Luminance, Logic Power Consumption, Lamp Power Consumption and Weight. To update Optical Characteristics. To update Internal circuit of LVDS inputs. To update Signal Electrical Characteristics. To update Parameter guide line for CFL Inverter. To add Luminance versus Lamp current. To update Timing Characteristics. To update Power Consumption. To update Power ON/OFF Sequence. To update Reference Drawing.
February 4,2002	OEM I-77C-02	1,5,6	Updated by establishment of New Company as "International Display Technology". To avoid using "inch" indication.

## 1.0 Handling Precautions

- 1) Since front polarizer is easily damaged, pay attention not to scratch it.
- 2) Be sure to turn off power supply when inserting or disconnecting from input connector.
- 3) Wipe off water drop immediately. Long contact with water may cause discoloration or spots.
- 4) When the panel surface is soiled, wipe it with absorbent cotton or other soft cloth.
- 5) Since the panel is made of glass, it may break or crack if dropped or bumped on hard surface.
- 6) Since CMOS LSI is used in this module, take care of static electricity and insure human earth when handling.
- 7) Do not open nor modify the Module Assembly.
- 8) Do not press the reflector sheet at the back of the module to any directions.
- 9) In case if a Module has to be put back into the packing container slot after once it was taken out from the container, do not press the center of the CFL Reflector edge.  
Instead, press at the far ends of the CFL Reflector edge softly. Otherwise the TFT Module may be damaged.
- 10) At the insertion or removal of the Signal Interface Connector, be sure not to rotate nor tilt the Interface Connector of the TFT Module.
- 11) After installation of the TFT Module into an enclosure ( Notebook PC Bezel, for example), do not twist nor bent the TFT Module even momentary. At designing the enclosure, it should be taken into consideration that no bending/twisting forces are applied to the TFT Module from outside. Otherwise the TFT Module may be damaged.
- 12) Cold cathode fluorescent lamp in LCD contains a small amount of mercury.  
Please follow local ordinances or regulations for disposal.
- 13) Small amount of materials having no flammability grade is used in the LCD module.  
The LCD module should be supplied by power complied with requirements of Limited Power Source (2.11, IEC60950 or UL1950), or be applied exemption conditions of flammability requirements (4.4.3.3, IEC60950 or UL1950) in an end product.
- 14) The LCD module is designed so that the CFL in it is supplied by Limited Current Circuit (2.4, IEC60950 or UL1950). Do not connect the CFL in Hazardous Voltage Circuit.

- The information contained herein is presented only as a guide for the applications of our products. No responsibility is assumed by International Display Technology for any infringements of patents or other right of the third parties which may result from its use. No license is granted by implication or otherwise under any patent or patent rights of International Display Technology or others.
- The information contained herein may be changed without prior notice. It is therefore advisable to contact International Display Technology before proceeding with the design of equipment incorporating this product.

## 2.0 General Description

This specification applies to the Type 14.1 Color TFT/LCD Module 'ITXG77C'.

This module is designed for a display unit of notebook style personal computer.

The screen format and electrical interface are intended to support the XGA (1024(H) x 768(V))screen.

Support color is native 262k colors ( RGB 6-bit data driver ).All input signals are LVDS interface compatible.

This module does not contain a inverter card for backlight.

## 2.1 Characteristics

The following items are characteristics summary on the table under 25 degree C condition:

ITEMS	SPECIFICATIONS
Screen Diagonal [cm]	35.7
Active Area [mm]	285.7(H) x 214.3(V)
Pixels H x V	1024(x3) x 768
Pixel Pitch [mm]	0.279(per one triad) x 0.279
Pixel Arrangement	R.G.B. Vertical Stripe
Display Mode	Normally White
Typical White Luminance [cd/m <sup>2</sup> ] Design Point 1:(ICFL=2.8mA) Design Point 2:(ICFL=6.0mA)	90 Typ.(Center), 85 Typ.(5 points average) 160 Typ.(Center),150 Typ.(5 points average)
Contrast Ratio	250 : 1 Typ.
Optical Rise Time/Fall Time [msec]	30 Typ. ,50Max.(each)
Nominal Input Voltage [Volt] VDD	+3.3 Typ.
Logic Power Consumption[watt] (VDD line)	1.2Typ.
Lamp Power Consumption [watt] Design Point 1:(ICFL=2.8mA) Design Point 2:(ICFL=6.0mA)	2.2 Typ. 3.9 Typ.
Weight [grams]	415 Typ.(w/o Inverter)
Physical Size [mm]	298.5(W) x 226.5(H) x 5.2(D) Typ.
Electrical Interface	6-bit digital video for each color R/G/B, 3 sync, Clock 4 pairs LVDS
Support Color	Native 262K colors ( RGB 6-bit data driver )
Temperature Range (degree C) Operating Storage (Shipping)	0 to +50 -20 to +60

## 2.2 Functional Block Diagram

The following diagram shows the functional block of the Type 14.1 Color TFT/LCD Module:

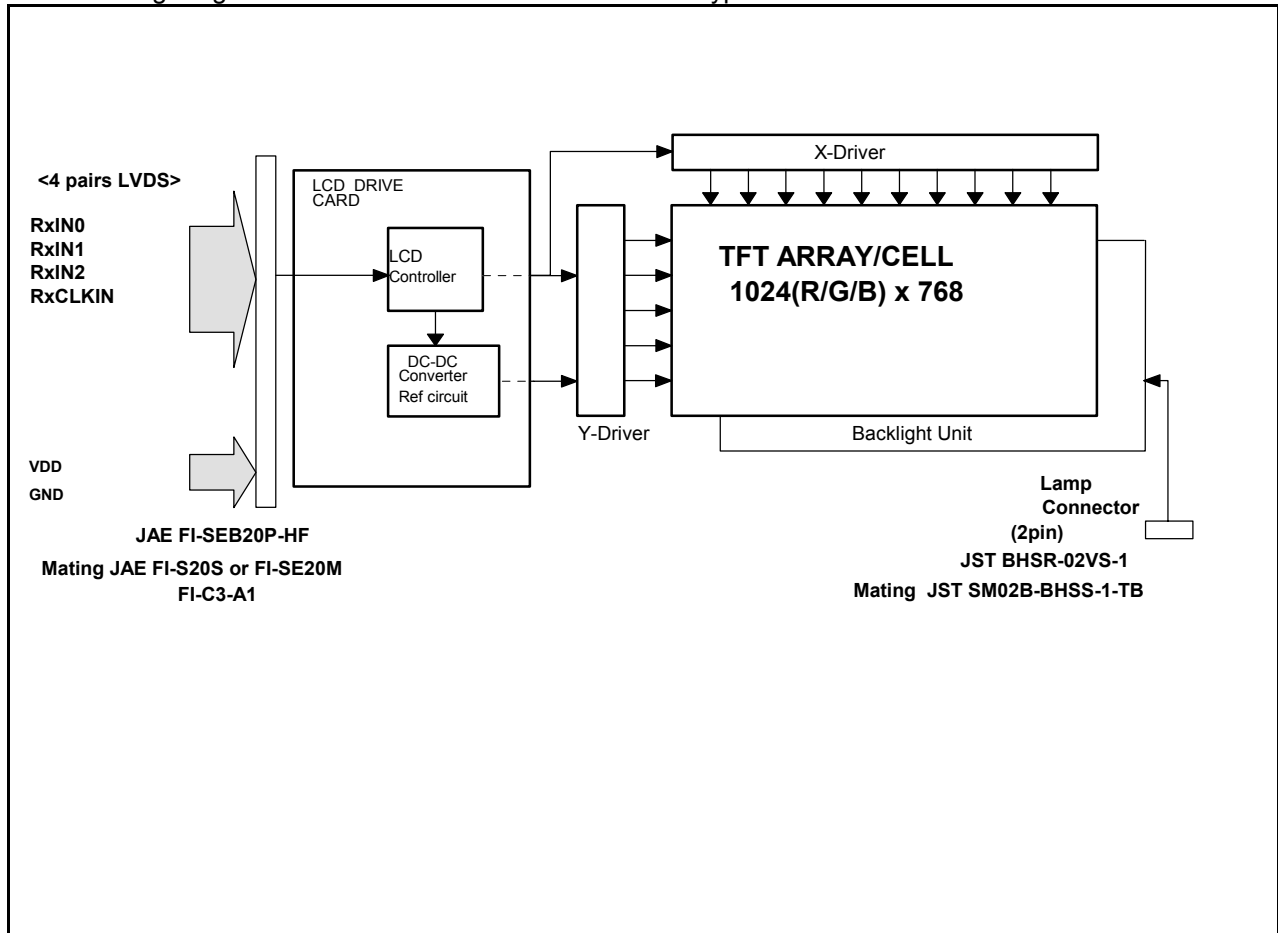

### 3.0 Absolute Maximum Ratings

Absolute maximum ratings of the module is as follows :

Item	Symbol	Min	Max	Unit	Conditions
Supply Voltage Logic/LCD Drive Voltage	VDD	-0.3	+4.0	V	
Input Voltage of Signal	Vin	-0.3	VDD+0.3	V	
CFL Inrush current	ICFLL	-	20	mA	Note 2
CFL Current	ICFL	-	6.5	mArms	
CFL Ignition Voltage	Vs	-	1,600	Vrms	
Operating Temperature	TOP	0	+50	deg.C	Note 1
Operating Relative Humidity	HOP	8	95	%RH	Note 1
Storage Temperature	TST	-20	+60	deg.C	Note 1
Storage Relative Humidity	HST	5	95	%RH	Note 1
Vibration			1.5 10-200	G Hz	
Shock			50 18	G ms	Half sine wave.

**Note 1 : Maximum Wet-Bulb should be 39 degree C and No condensation.**

**Note 2 : Duration=50 msec Max.**

## 4.0 Optical Characteristics

The optical characteristics are measured under stable conditions as follows under 25 deg.C condition:

Item	Conditions	Specification	
		Typ.	Note
Viewing Angle (Degrees)	Horizontal (Right)	40	-
	$K \geq 10$ (Left)	40	-
K:Contrast Ratio	Vertical (Upper)	15	-
	$K \geq 10$ (Lower)	30	-
Contrast ratio		250	-
Response Time (ms)	Rising	30	50(Max)
	Falling	30	50(Max)
Color Chromaticity (CIE)	Red x	0.577	-
	Red y	0.338	-
	Green x	0.310	-
	Green y	0.554	-
	Blue x	0.158	-
	Blue y	0.124	-
	White x	0.313	-
	White y	0.329	-
White Luminance (cd/m <sup>2</sup> ) CFL 6.0mA		160 Center 150 5 points average	



## 5.0 Signal Interface

### 5.1 Connectors

Physical interface is described as for the connector on module.

These connectors are capable of accommodating the following signals and will be following components.

Connector Name / Designation	For Signal Connector
Manufacturer	JAE
Type / Part Number	FI-SEB20P-HF
Mating Housing/Part Number	FI-S20S or FI-SE20M or FI-S20S with shell.
Mating Contact/Part Number	FI-C3-A1

Connector Name / Designation	For Lamp Connector
Manufacturer	JST
Type / Part Number	BHSR-02VS-1
Mating Type / Part Number	SM02B-BHSS-1-TB

### 5.2 Signal Pin

Pin#	Signal	Pin#	Signal
1	VDD	11	RxIN2-
2	VDD	12	RxIN2+
3	GND	13	GND
4	GND	14	RxCLKIN-
5	RxIN0-	15	RxCLKIN+
6	RxIN0+	16	GND
7	GND	17	Reserved
8	RxIN1-	18	Reserved
9	RxIN1+	19	GND
10	GND	20	GND

### 5.3 Signal Description

The module uses a LVDS compatible receiver. LVDS is a differential signal technology for LCD interface and high speed data transfer device. Transmitter shall be SN75LVDS84(negative edge sampling) or compatible.

Signal Name	Description
RxIN0+, RxIN0-	LVDS differential data input (Red0-Red5, Green0)
RxIN1+, RxIN1-	LVDS differential data input (Green1-Green5,Blue0-Blue1)
RxIN2+, RxIN2-	LVDS differential data input (Blue2-Blue5, HSync, VSync, DSPTMG)
RxCLKIN+, RxCLKIN-	LVDS differential clock input
VDD	+3.3V Power Supply
GND	Ground

**Note:** Input signals shall be low or Hi-Z state when VDD is off.

Internal circuit of LVDS inputs are as follows:

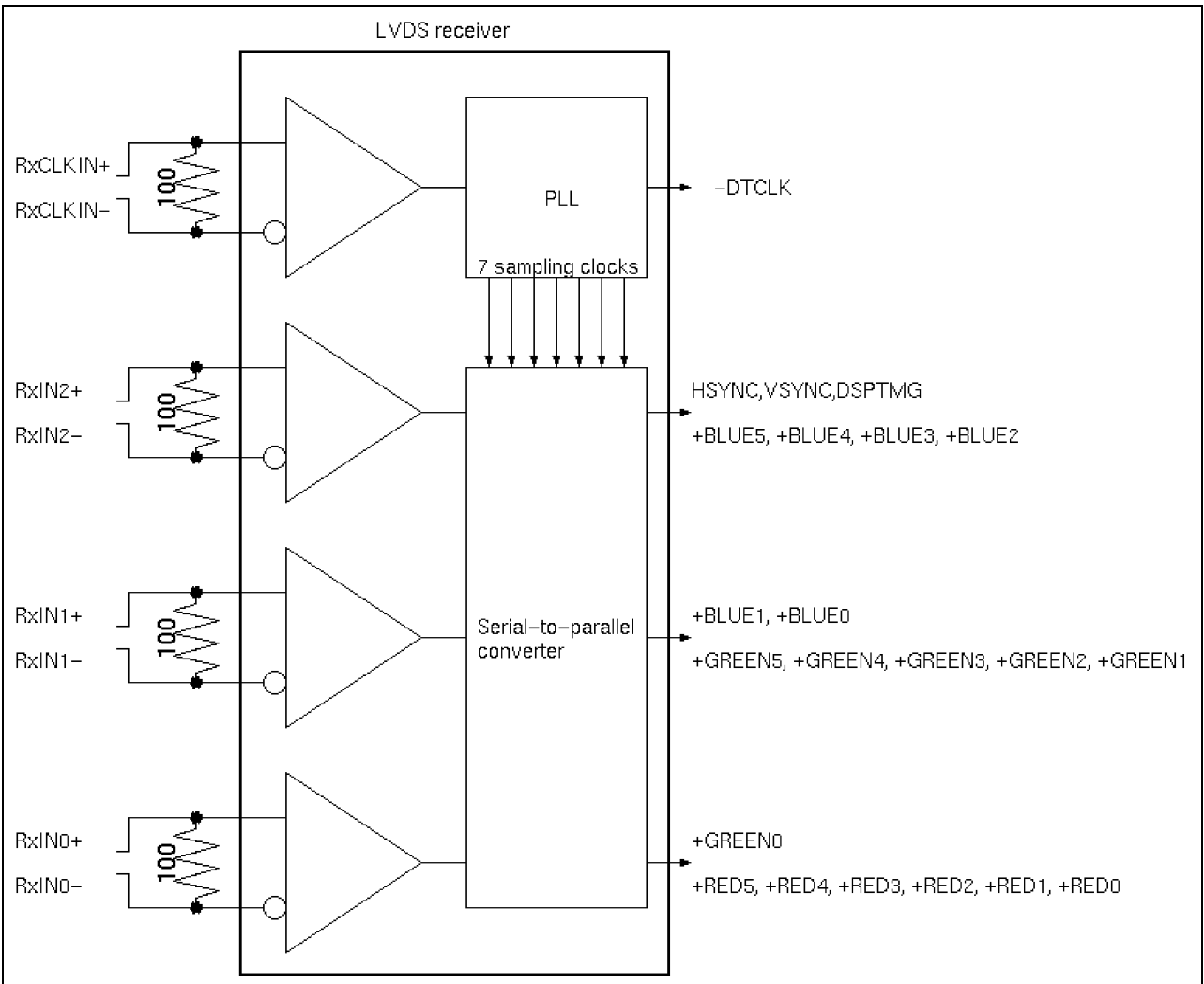

The module uses a 100ohm resistor between positive and negative data lines of each receiver input.

<b>SIGNAL NAME</b>	<b>Description</b>	
+RED5 +RED4 +RED3 +RED2 +RED1 +RED0	Red Data 5 (MSB) Red Data 4 Red Data 3 Red Data 2 Red Data 1 Red Data 0 (LSB)  <b>Red-pixel Data</b>	Red-pixel Data Each red pixel's brightness data consists of these 6 bits pixel data.
+GREEN 5 +GREEN 4 +GREEN 3 +GREEN 2 +GREEN 1 +GREEN 0	Green Data 5 (MSB) Green Data 4 Green Data 3 Green Data 2 Green Data 1 Green Data 0 (LSB)  <b>Green-pixel Data</b>	Green-pixel Data Each green pixel's brightness data consists of these 6 bits pixel data.
+BLUE 5 +BLUE 4 +BLUE 3 +BLUE 2 +BLUE 1 +BLUE 0	Blue Data 5 (MSB) Blue Data 4 Blue Data 3 Blue Data 2 Blue Data 1 Blue Data 0 (LSB)  <b>Blue-pixel Data</b>	Blue-pixel Data Each blue pixel's brightness data consists of these 6 bits pixel data.
-DTCLK	<b>Data Clock</b>	The typical frequency is 65.0 MHz. The signal is used to strobe the pixel data and DSPTMG signals. All pixel data shall be valid at the falling edge when the DSPTMG signal is high.
DSPTMG	<b>Display Timing</b>	This signal is strobed at the falling edge of -DTCLK. When the signal is high, the pixel data shall be valid to be displayed.
VSYNC	<b>Vertical Sync</b>	The signal is synchronized to -DTCLK .
HSYNC	<b>Horizontal Sync</b>	The signal is synchronized to -DTCLK .

**Note:** Output signals from any system shall be low or Hi-Z state when VDD is off.

### 5.4 Signal Electrical Characteristics

Input signals shall be low or Hi-Z state when VDD is off.  
 It is recommended to refer the specifications of SN75LVDS86DGG(Texas Instruments) in detail.

#### Interface signal electrical characteristics

Parameter	Symbol	Min	Typ	Max	Unit	Conditions
Differential Input High Threshold	Vth			+100	[mV]	Vcm=+1.2V
Differential Input Low Threshold	Vtl	-100			[mV]	Vcm=+1.2V
Magnitude Differential Input Voltage	Vid	100		600	[mV]	
Common Mode Voltage	Vcm	1.0	1.2	1.4	[V]	Vth - Vtl = 200mV
Common Mode Voltage Offset	$\Delta V_{cm}$	-50		+50	[mV]	Vth - Vtl = 200mV

**Note :** Input signals shall be low or HiZ state when VDD is off.

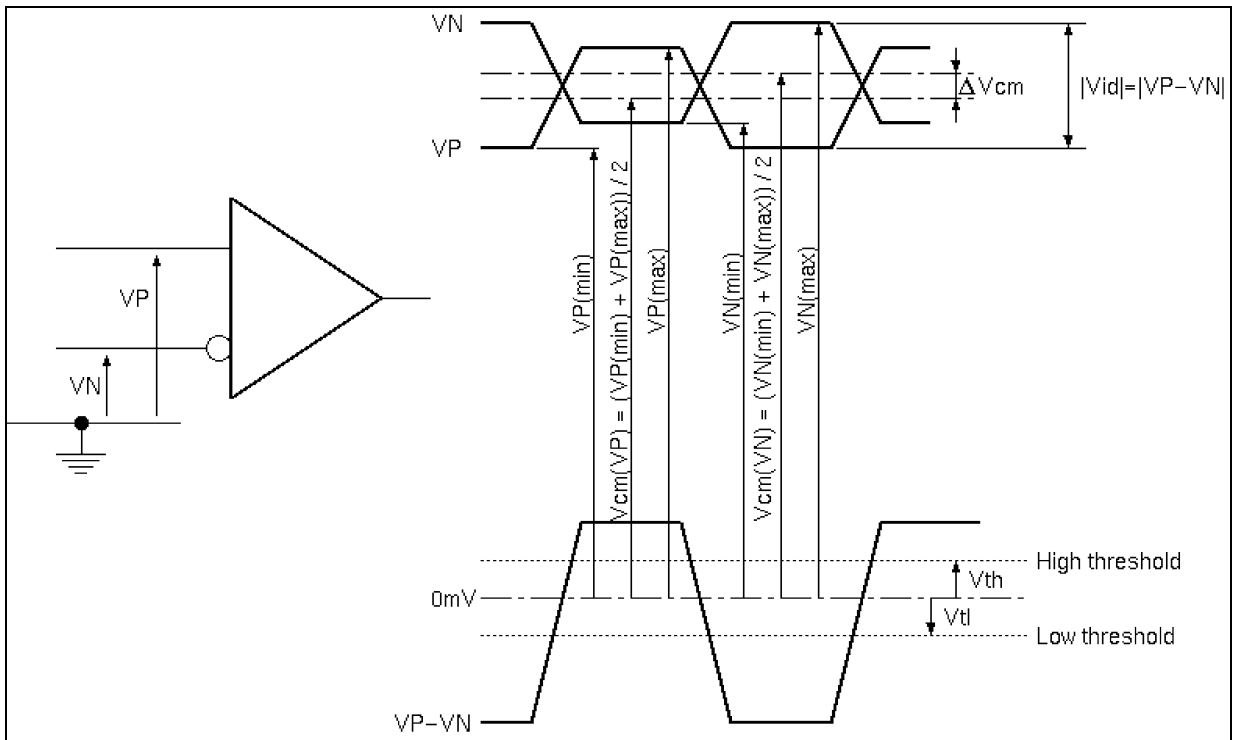

Voltage Definitions

### Switching Characteristics

Parameter	Symbol	Min	Typ	Max	Unit	Conditions (Note 1)
Clock Frequency	fc	50	65	67	[MHz]	
Cycle Time	tc	14.93	15.38	20.00	[ns]	
Data Setup Time	Tsu	600			[ps]	fc = 65MHz, jitter < 50ps, Vth-Vtl = 200mV, Vcm = 1.2V, ΔVcm = 0
Data Hold Time	Thd	600			[ps]	
Cycle-to-cycle jitter	tCCJ	-150		+150	[ps]	(Note 2)
Cycle modulation rate	tCJavg			20	[ps/clock]	(Note 3)

Note;

1. All values are at VDD=3.3V, Ta=25 degree C.
2. Jitter is the magnitude of the change in input clock period.
3. This specification defines maximum average cycle modulation rate in peak-to-peak transition within any 100 clock cycles. This specification is applied only if input clock peak jitter within any 100 clock cycles is greater than 300ps.

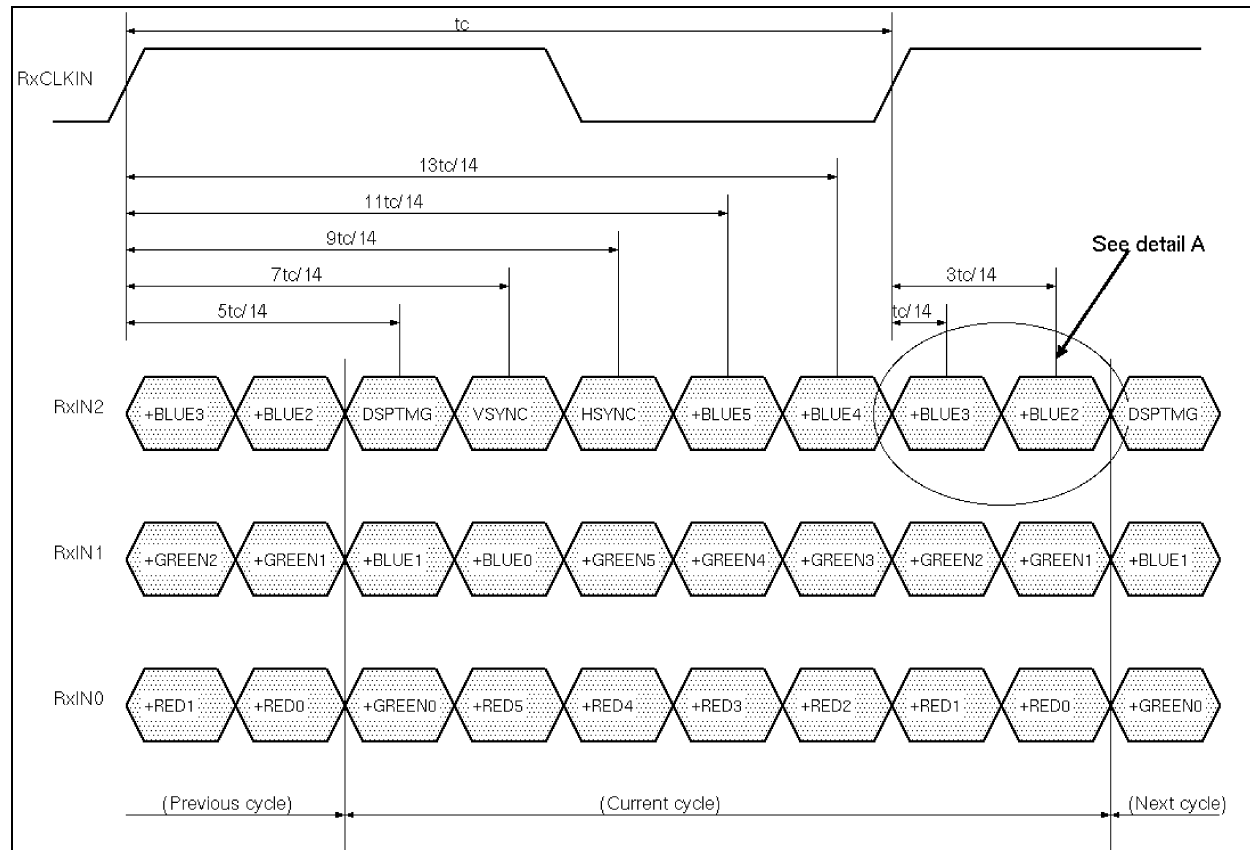

LVDS Timing

**Detail A**

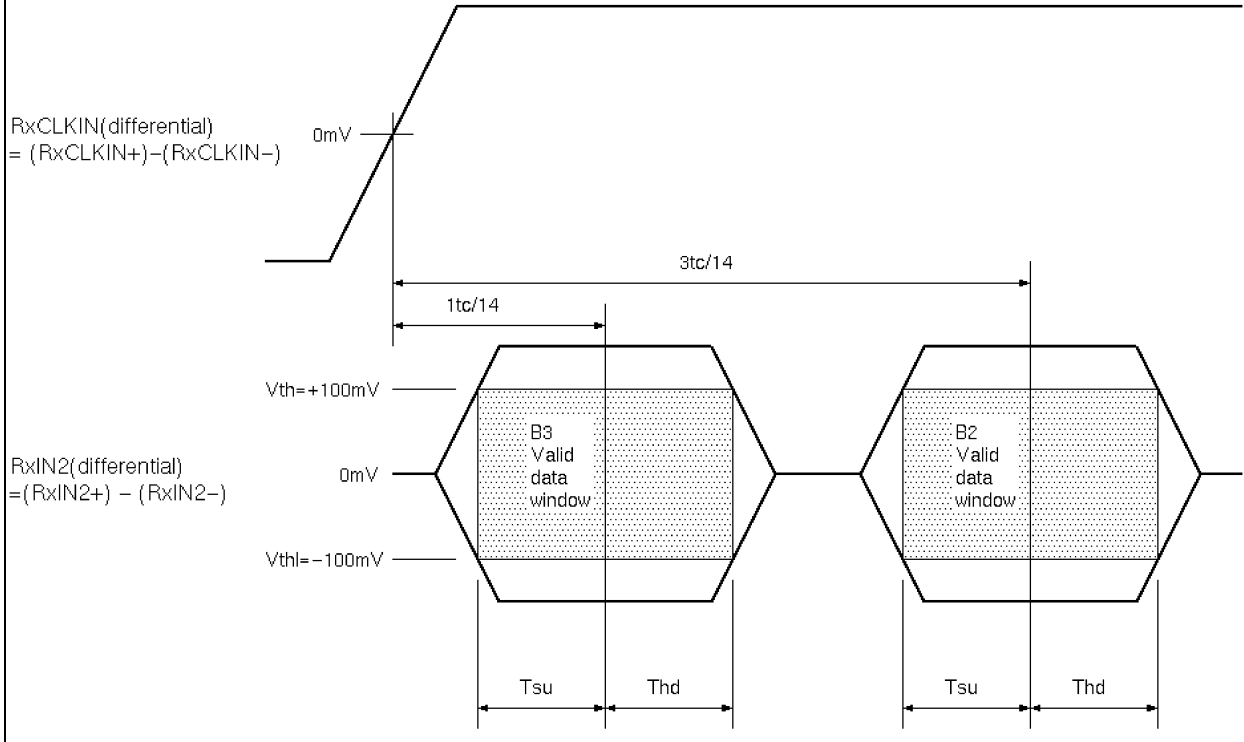

LVDS Timing(Detail A)

**5.5 Signal for Lamp connector**

Pin #	Signal Name
1	Lamp High Voltage
2	Lamp Low Voltage

## 6.0 Pixel format image

Following figure shows the relationship of the input signals and LCD pixel format image.

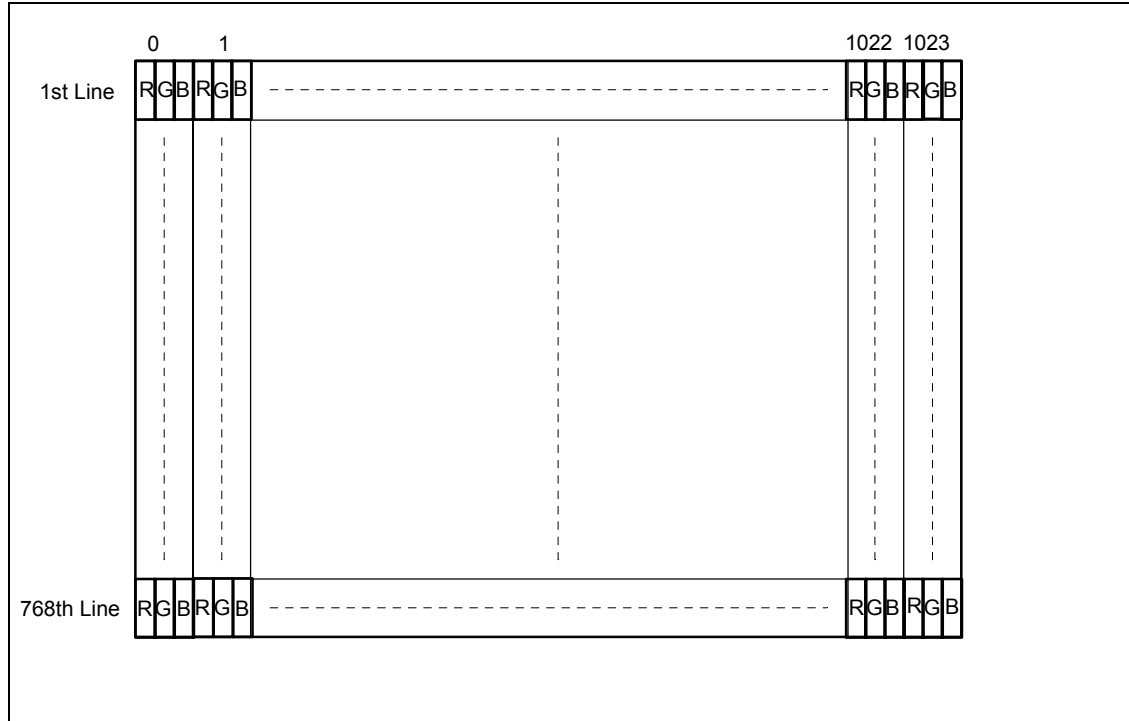



## 7.0 Parameter guide line for CFL Inverter

PARAMETER	MIN	DP-1	DP-2	MAX	UNITS	CONDITION
White Luminance center 5 points average	-	90 85	160 150	-	cd/m <sup>2</sup>	(Ta=25 deg.C)
CFL current(ICFL)	2.5	2.8	6.0	6.4	mArms	(Ta=25 deg.C) <b>Note 4</b>
CFL Frequency(FCFL)	40	50	50	60	KHz	(Ta=25 deg.C) <b>Note 1</b>
CFL Ignition Voltage(Vs)	1,400	-	-	-	Vrms	(Ta= 0 deg.C) <b>Note 3</b>
CFL Voltage (Reference)(VCFL)	-	-	650	-	Vrms	(Ta=25 deg.C) <b>Note 2</b>
CFL Power consumption(PCFL)	-	2.2	3.9	-	W	(Ta=25 deg.C) <b>Note 2</b>

**Note 1:** CFL discharge frequency must be carefully determined to avoid interference between inverter and TFT LCD.

**Note 2:** Calculated value for reference (ICFL x VCFL = PCFL).

**Note 3:** CFL inverter should be able to give out a power that has a generating capacity of over 1,400 voltage. Lamp units need 1,400 voltage minimum for ignition.

**Note 4:** It should be employed the inverter which has "Duty Dimming", if ICFL is less than 4 mA.

**Note 5:** DP-1(Design Point-1) and DP-2(Design Point-2) are recommended Design Point.

\*1 All of characteristics listed are measured under the condition using the Test inverter.

\*2 In case of using an inverter other than listed, it is recommended to check the inverter carefully. Sometimes, interfering noise stripes appear on the screen, and substandard luminance or flicker at low power may happen.

\*3 In designing an inverter, it is suggested to check safety circuit very carefully. Impedance of CFL, for instance, becomes more than 1 [M ohm] when CFL is damaged.

\*4 Generally, CFL has some amount of delay time after applying kick-off voltage. It is recommended to keep on applying kick-off voltage for 1 [Sec] until discharge.

\*5 Reducing CFL current increases CFL discharge voltage and generally increases CFL discharge frequency. So all the parameters of an inverter should be carefully designed so as not to produce too much leakage current from high-voltage output of the inverter.

The following chart is Luminance versus Lamp current for your reference.

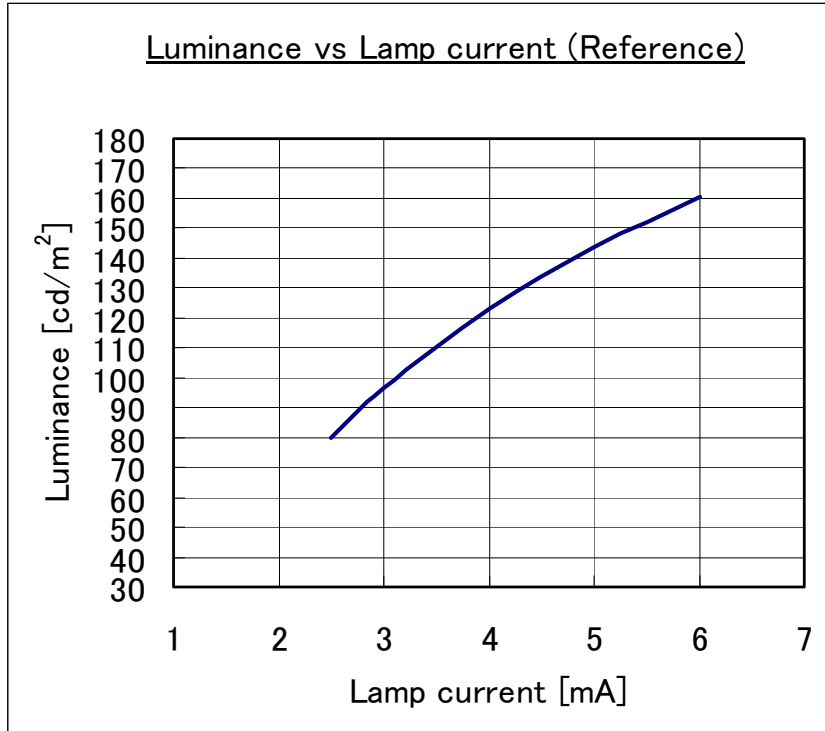

## 8.0 Interface Timings

Basically, interface timings should match the VESA 1024x768 / 60 Hz (VG901101) manufacturing guide line timing.

### 8.1 Timing Characteristics

Symbol		MIN	TYP	MAX	Unit	Unit
fdck	DTCLK Frequency	50.0	65.00	67.0	MHz	
tck	DTCLK cycle time	14.93	15.38	20.0	nsec	
tx	X total time	1206	1344	2047	tck	
tacx	X active time	1024	1024	1024	tck	
tbkx	X blank time	90	320		tck	1
Hsync	H frequency		48.363		KHz	
Hsw	H-Sync width	2	136		tck	2
Hbp	H back porch	1	160		tck	2
Hfp	H front porch	0	24		tck	
ty	Y total time	777	806	1023	tx	
tacy	Y active time	768	768	768	tx	
Vsync	Frame rate	(55)	60	61	Hz	
Vw	V-sync Width	1	6		tx	
Vfp	V-sync front porch	1	3		tx	
Vbp	V-sync back porch	7	29	63	tx	3

**Note:**

1.  $tbkx = Hfp + Hsw + Hbp$
2.  $Hsw + Hbp$  should be less than 515 [tck].
3.  $Vbp$  should be static

## 8.2 Timing Definition

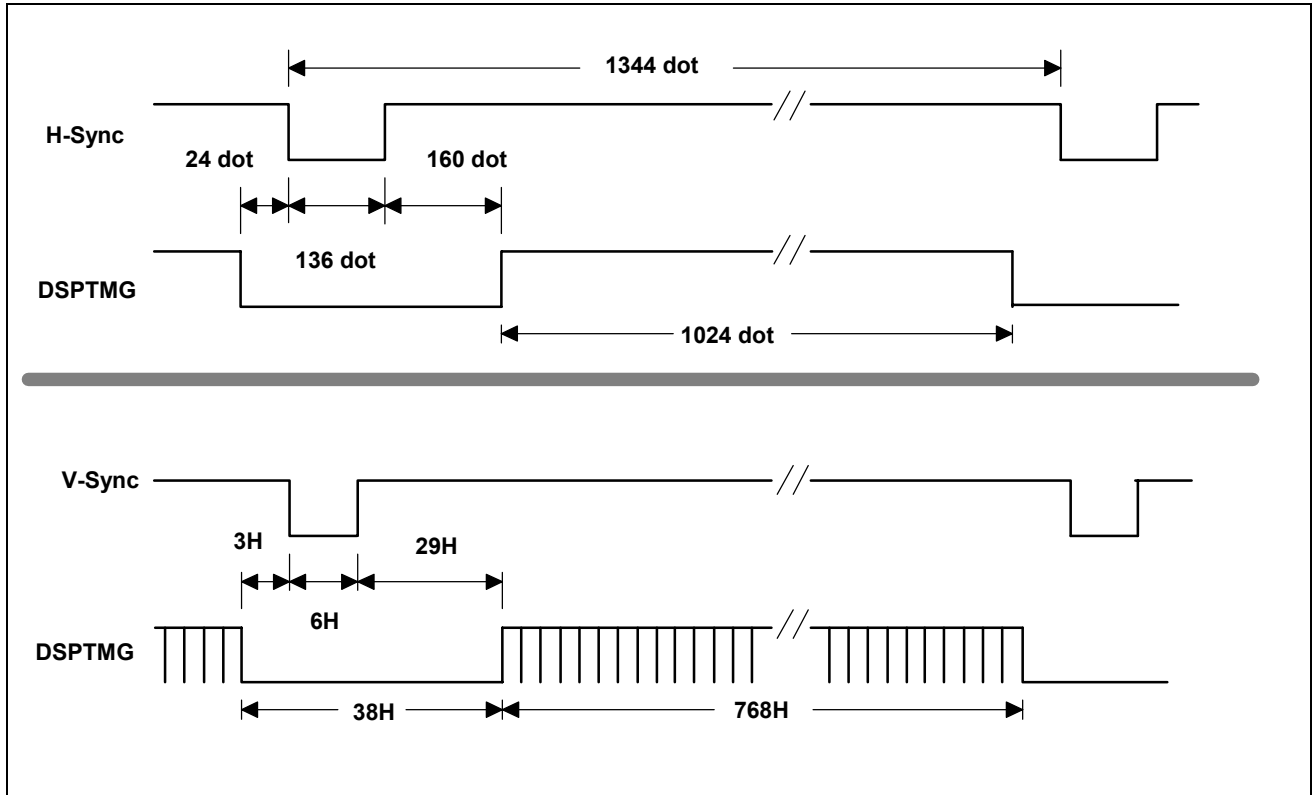

## 9.0 Power Consumption

Input power specifications are as follows;

SYMBOL	PARAMETER	Min	Typ	Max	UNITS	CONDITION
VDD	Logic/LCD Drive Voltage	3.0	3.3	3.6	[V]	Load Capacitance 20[uF]
PDD	VDD Power			1.6	[W]	Max. Pattern, VDD=3.6[V]
PDD	VDD Power		1.2		[W]	All Black Pattern, VDD=3.3[V]
IDD	VDD Current			460	[mA]	Max Pattern, VDD=3.0[V]
IDD	VDD Current		350		[mA]	All Black Pattern, VDD=3.3[V]
VDDrp	Allowable Logic/LCD Drive Ripple Voltage			100	[mVp-p]	
VDDns	Allowable Logic/LCD Drive Ripple Noise			100	[mVp-p]	

## 10.0 Power ON/OFF Sequence

VDD power and lamp on/off sequence is as follows. Interface signals are also shown in the chart. Signals from any system shall be Hi-Z state or low level when VDD is off.

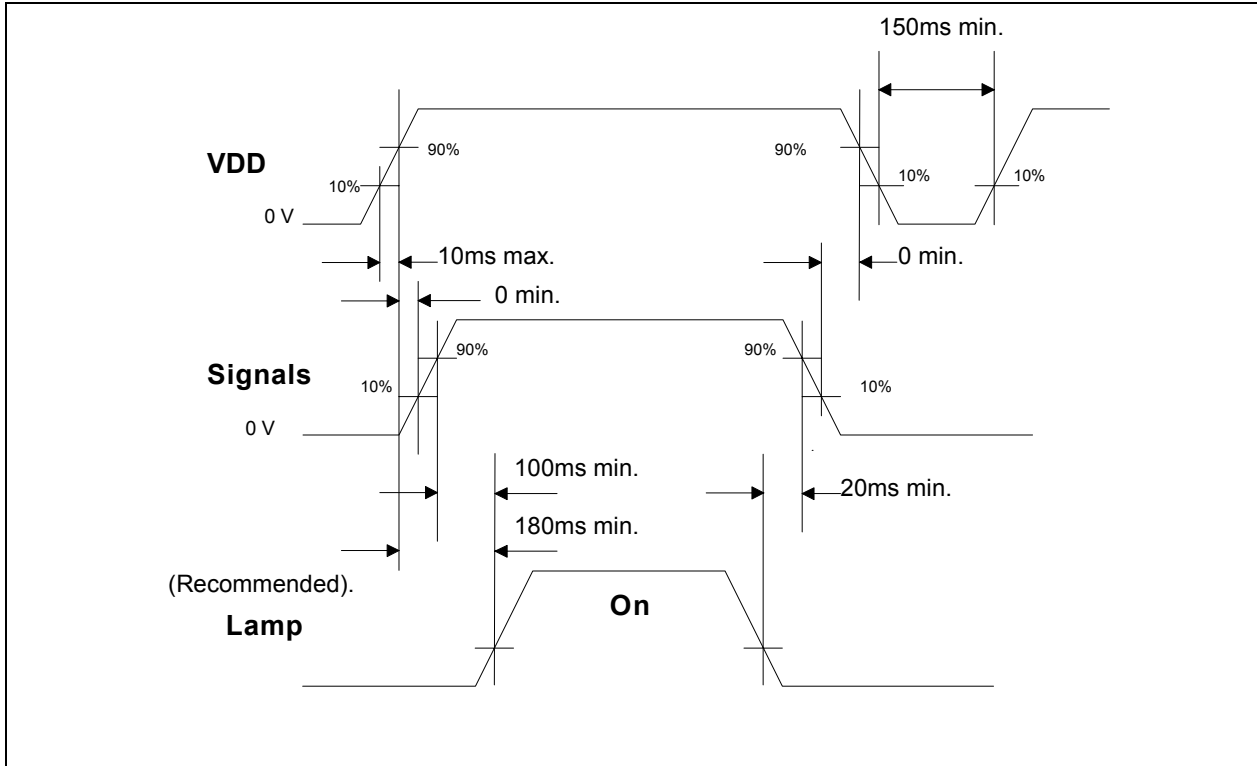

# 11.0 Mechanical Characteristics

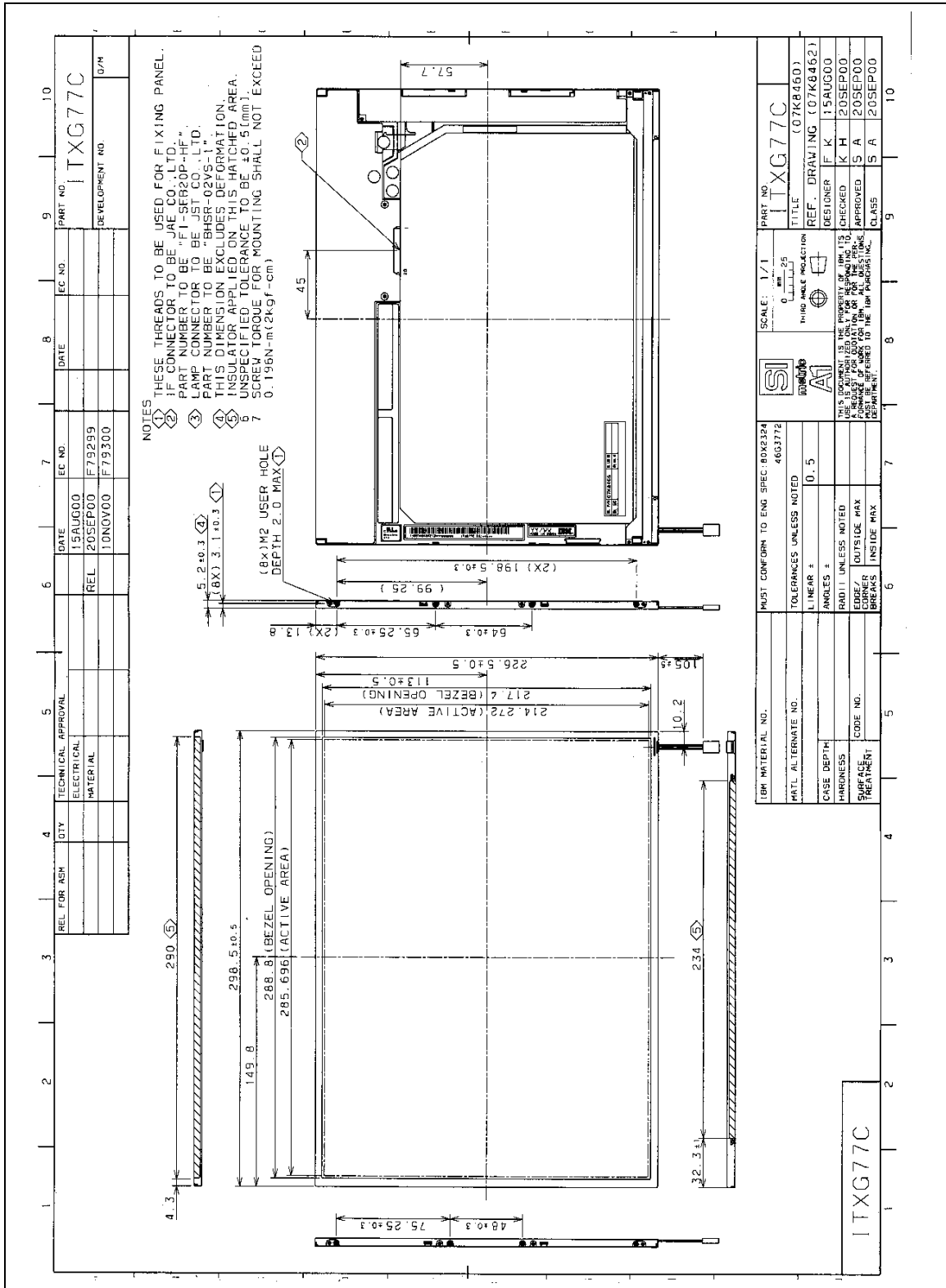

## 12.0 National Test Lab Requirement

The display module will be authorized to Apply the UL Recognized Mark.

### Conditions of Acceptability

- This component has been judged on the basis of the required spacings in the Standard for Safety of Information Technology Equipment, Including Electrical Business Equipment, CAN/CSA C22.2 No.950-95 \*UL 1950, Third Edition, including revisions through revision date March 1,1998, which are based on the Fourth Amendment to IEC 950, Second Edition, which would cover the component itself if submitted for Listing.
- CF Lamp circuit for this model should be supplied from Limited Current Circuit.
- The units are supplied by Limited Power Sources.
- The terminals and connectors are suitable for factory wiring only.
- The terminals and connectors have not been evaluated for field wiring.
- A suitable Electrical and Fire enclosure shall be provided.

\*\*\*\*\* End Of Page \*\*\*\*\*