

Off-Line Digital Green-Mode PWM Controller Integrated with Power BJT and OTP

1 Description

The iW1816 is a high performance AC/DC power supply control device which uses digital control technology to build peak current mode PWM flyback power supplies. This device includes an internal power BJT and operates in quasi-resonant mode to provide high efficiency along with a number of key built-in protection features while minimizing the external component count, simplifying EMI design, and lowering the total bill of material cost. The iW1816 removes the need for secondary feedback circuit while achieving excellent line and load regulation. It also eliminates the need for loop compensation components while maintaining stability in all operating conditions. The pulse-by-pulse waveform analysis allows for a loop response that is much faster than traditional solutions, resulting in improved dynamic load response for both one-time and repetitive load transients. The built-in power limit function enables optimized transformer design in universal off-line applications and allows for a wide input voltage range.

Dialog's innovative proprietary technology ensures that power supplies built with the iW1816 can achieve highest average efficiency, lowest standby power consumption, and fast smooth startup with a wide range of output voltage (5V, 12V and above) and capacitive loads (from 330 μ F to 6,000 μ F).

2 Features

- **PrimAccurate**[™] primary-side feedback eliminates opto-isolators and simplifies design
- Internal 800-V bipolar junction transistor (BJT)
- Adaptively controlled soft start-up enables fast and smooth start-up for a wide range of output voltage (5V, 12V and above) and capacitive loads up to 6,000 μ F
- 64kHz PWM switching frequency
- No-load power consumption < 30mW at 230V_{AC} with typical application circuit
- Fast dynamic load response for both one-time and repetitive load transients
- Adaptive multi-mode PWM/PFM control improves efficiency
- Quasi-resonant operation for highest overall efficiency
- **EZ-EMI**[®] design easily meets global EMI standards
- Very tight constant voltage and constant current regulation with primary-side-only feedback
- No external compensation components required
- Built-in single-point fault protections against output short circuit, output over-voltage, and current-sense-resistor short-circuit faults
- Built-in over-temperature protection (OTP)
- No audible noise over entire operating range

3 Applications

- Low-power AC/DC power supply for smart meters, motor control, home appliances, networking devices and industrial applications
- Linear AC/DC replacement

Off-Line Digital Green-Mode PWM Controller Integrated with Power BJT and OTP

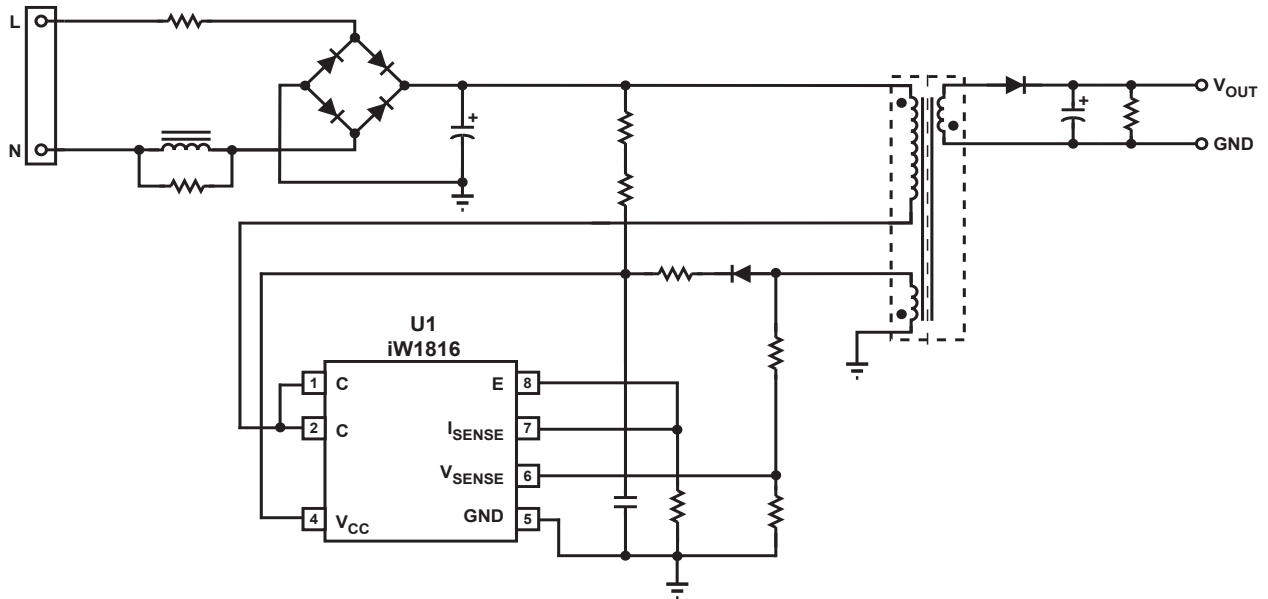

Figure 3.1 : iW1816 Typical Application Circuit

WARNING:

The iW1816 is intended for high voltage AC/DC offline applications. Contact with live high voltage offline circuits or improper use of components may cause lethal or life threatening injuries or property damage. Only qualified professionals with safety training and proper precaution should operate with high voltage offline circuits.

iW1816 Output Power Table at Universal Input (85V_{AC}–264V_{AC})

Condition	Adapter ¹	Open Frame ²
Output Power (W)	4.0	5.0

Notes:

1. Maximum practical continuous output power measured at enclosure internal ambient temperature of 60°C and device emitter pin (pin 8) temperature of ≤ 90°C (adapter is placed in a non-ventilated environment).
2. Maximum practical continuous output power measured at open frame ambient temperature of 50°C and device emitter pin (pin 8) temperature of ≤ 90°C while minimum bulk capacitor voltage is kept above 90V and no special heatsinking is used (test unit is placed in a non-ventilated environment).
3. The output power can vary depending on the power supply system designs and operating conditions. See Section 10.14 for more details.

Off-Line Digital Green-Mode PWM Controller Integrated with Power BJT and OTP

4 Pinout Description

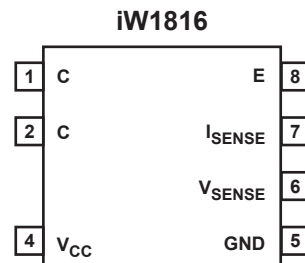

Figure 4.1 : 7-Pin SOIC Package

Pin No.	Pin Name	Type	Pin Description
1	C	BJT Collector	Collector of internal bipolar junction transistor (BJT).
2	C	BJT Collector	Collector of internal BJT.
4	V _{CC}	Power Input	Power supply for control logic.
5	GND	Ground	Ground.
6	V _{SENSE}	Analog Input	Auxiliary voltage sense (used for primary-side regulation).
7	I _{SENSE}	Analog Input	Primary current sense. Used for cycle-by-cycle peak current control and current limit.
8	E	BJT Emitter	Emitter of internal BJT (pin 7 and pin 8 must be shorted externally on the PCB).

Off-Line Digital Green-Mode PWM Controller Integrated with Power BJT and OTP

5 Absolute Maximum Ratings

Absolute maximum ratings are the parameter values or ranges which can cause permanent damage if exceeded. For maximum safe operating conditions, refer to Electrical Characteristics in Section 7.0. ($T_A = 25^\circ\text{C}$, unless otherwise noted). Proper design precautions must be made to ensure that the internal die junction temperature of the iW1816 does not exceed 150°C . Otherwise permanent damage to the device may occur.

Parameter	Symbol	Value	Units
DC supply voltage range (pin 4, $I_{CC} = 20\text{mA}$ max)	V_{CC}	-0.3 to 18	V
Continuous DC supply current at V_{CC} pin ($V_{CC} = 15\text{V}$)	I_{CC}	20	mA
V_{SENSE} input (pin 6, $I_{V_{sense}} \leq 10\text{mA}$)		-0.7 to 4.0	V
I_{SENSE} input (pin 7)		-0.3 to 4.0	V
ESD rating per JEDEC JESD22-A114		$\pm 2,000$	V
Latch-up test per JESD78A		± 100	mA
Collector-Emitter breakdown voltage (Emitter and base shorted together; $I_C = 1\text{mA}$, $R_{EB} = 0\Omega$)	V_{CES}	800	V
Collector current ¹	I_C	1.5	A
Collector peak current ¹ ($t_p < 1\text{ms}$)	I_{CM}	3	A
Maximum junction temperature	T_{JMAX}	150	$^\circ\text{C}$
Storage temperature	T_{STG}	-55 to 150	$^\circ\text{C}$
Lead temperature during IR reflow for ≤ 15 seconds	T_{LEAD}	260	$^\circ\text{C}$

Notes:

Note 1: Limited by maximum junction temperature.

6 Thermal Characteristics

Parameter	Symbol	Value	Units
Thermal Resistance Junction-to-Ambient ¹	θ_{JA}	132	$^\circ\text{C}/\text{W}$
Thermal Resistance Junction-to-GND pin (pin 5) ²	ψ_{JB}	71	$^\circ\text{C}/\text{W}$
Thermal Resistance Junction-to-Collector pin (pin 1) ²	ψ_{J-BJT}	49	$^\circ\text{C}/\text{W}$
Thermal Shutdown Threshold ³	T_{SD}	150	$^\circ\text{C}$
Thermal Shutdown Recovery ³	T_{SD-R}	100	$^\circ\text{C}$

Notes:

- θ_{JA} is measured in a one-cubic-foot natural convection chamber.
- ψ_{JB} [Psi Junction to Board] provides an estimation of the die junction temperature relative to the PCB [Board] surface temperature. ψ_{J-BJT} [Psi Junction to Collector pin] provides an estimation of the die junction temperature relative to the collector pin [internal BJT Collector] surface temperature. ψ_{JB} is measured at the ground pin (pin 5) without using any thermal adhesives.. See Section 10.14 for more information.
- These parameters are typical and they are guaranteed by design.

Off-Line Digital Green-Mode PWM Controller Integrated with Power BJT and OTP

7 Electrical Characteristics

 $V_{CC} = 12V, -40^{\circ}C \leq T_A \leq 85^{\circ}C$

Parameter	Symbol	Test Conditions	Min	Typ	Max	Unit
V_{SENSE} SECTION (Pin 6)						
Input leakage current	I_{BVS}	$V_{SENSE} = 2V$			1	V
Nominal voltage threshold	$V_{SENSE(NOM)}$	$T_A = 25^{\circ}C$, negative edge	1.518	1.533	1.548	V
Output OVP threshold	$V_{SENSE(MAX)}$	$T_A = 25^{\circ}C$, negative edge		1.834		V
I_{SENSE} SECTION (Pin 7)						
Over-current threshold	V_{OCP}		1.11	1.15	1.19	V
I _{SENSE} regulation upper limit (Note 1)	$V_{IPK(HIGH)}$			1.0		V
I _{SENSE} regulation lower limit (Note 1)	$V_{IPK(LOW)}$			0.23		V
Input leakage current	I_{LK}	$I_{SENSE} = 1.0V$			1	μA
V_{CC} SECTION (Pin 4)						
Maximum operating voltage (Note 1)	$V_{CC(MAX)}$				16	V
Start-up threshold	$V_{CC(ST)}$	V_{CC} rising	10.0	11.0	12.0	V
Under-voltage lockout threshold	$V_{CC(UVL)}$	V_{CC} falling	3.8	4.0	4.2	V
Start-up current	$I_{IN(ST)}$	$V_{CC} = 10V$	1.0	1.7	3.0	μA
Quiescent current	I_{CCQ}	No I_B current		2.7	4.0	mA
Zener breakdown voltage	V_{ZB}	Zener current = 5mA $T_A = 25^{\circ}C$	18.5	19.5	20.5	V
BJT Section (Pin 1, Pin 2, and Pin 8)						
Collector cutoff current	I_{CB0}	$V_{CB} = 800V, I_E = 0A$			0.01	mA
Collector-emitter cutoff current	I_{CES}	$V_{CE} = 800V, R_{EB} = 0\Omega, T_A = 25^{\circ}C$			0.01	mA
		$V_{CE} = 800V, R_{EB} = 0\Omega, T_A = 100^{\circ}C$			0.02	
		$V_{CE} = 500V, R_{EB} = 0\Omega, T_A = 25^{\circ}C$			0.005	
DC Current Gain (Note 2)	h_{FE}	$V_{CE} = 5V, I_C = 0.2A$	15		40	
		$V_{CE} = 5V, I_C = 0.3A$	10		30	
		$V_{CE} = 5V, I_C = 1mA$	10			

Off-Line Digital Green-Mode PWM Controller Integrated with Power BJT and OTP

$V_{CC} = 12V$, $-40^{\circ}C \leq T_A \leq 85^{\circ}C$, unless otherwise specified

6 Electrical Characteristics (continued)

Parameter	Symbol	Test Conditions	Min	Typ	Max	Unit
Collector-Base breakdown voltage	V_{CB0}	$I_C = 0.1mA$	800			V
Collector-Emitter breakdown voltage (Emitter and base shorted together)	V_{CES}	$I_C = 1mA$, $R_{EB} = 0\Omega$	800			V
Collector-Emitter sustain voltage	$V_{CEO(SUS)}$	$I_C = 1mA$, $L_M = 25mH$	500			V
Collector-Emitter saturation voltage ²	$V_{CE(SAT)}$	$I_C = 0.1A$, $I_B = 0.02A$		0.1	0.3	V
PWM switching frequency ³	f_{SW}	> 50% load		64		kHz

Notes:

1. These parameters are not 100% tested. They are guaranteed by design and characterization.
2. Impulse $t_p \leq 300\mu s$, duty cycle $\leq 2\%$.
3. Operating frequency varies based on the load conditions, see Section 10.6 for more details.

Off-Line Digital Green-Mode PWM Controller Integrated with Power BJT and OTP

8 Typical Performance Characteristics

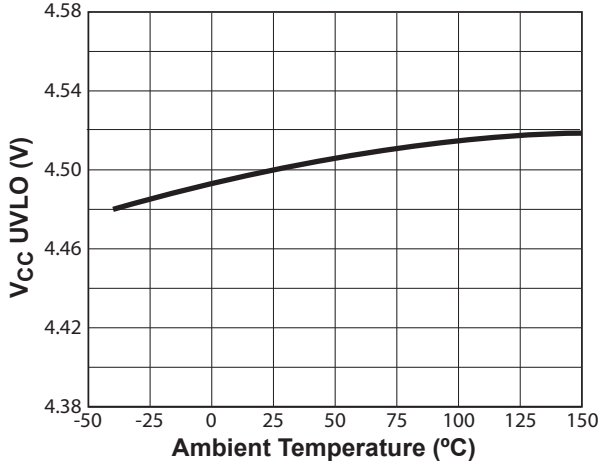

Figure 8.1 : V_{CC} UVLO vs. Temperature

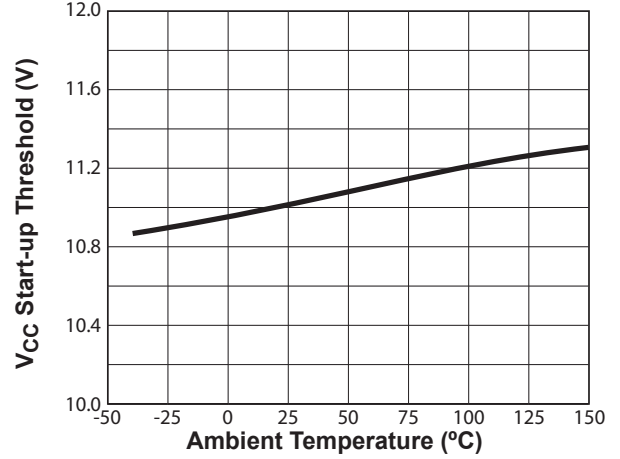

Figure 8.2 : Start-Up Threshold vs. Temperature

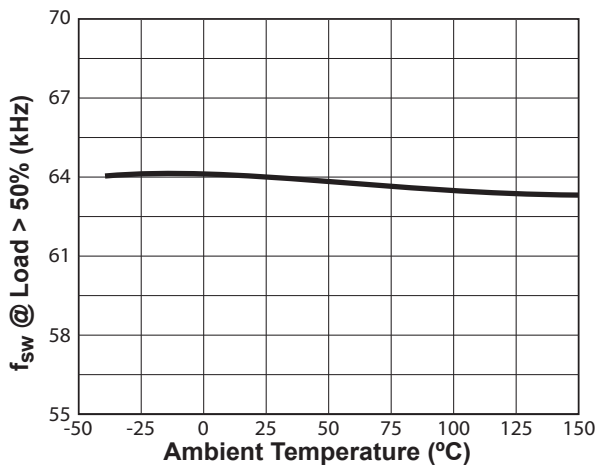

Figure 8.3 : Switching Frequency vs. Temperature

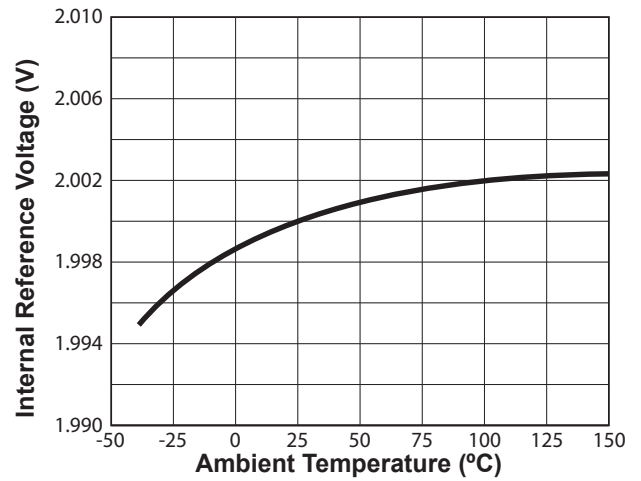

Figure 8.4 : Internal Reference vs. Temperature

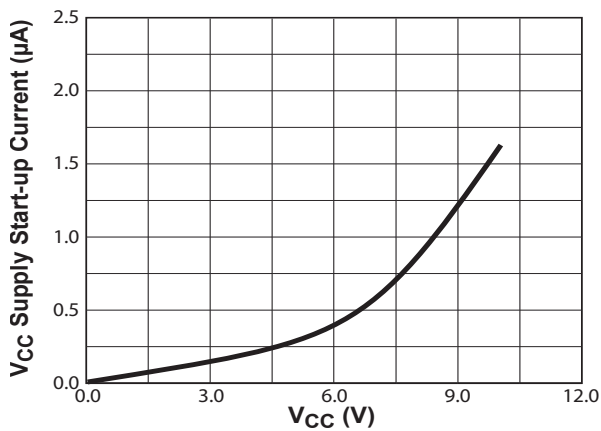

Figure 8.5 : V_{CC} vs. V_{CC} Supply Start-up Current

Notes:

1. Operating frequency varies based on the load conditions, see Section 10.6 for more details.

Off-Line Digital Green-Mode PWM Controller
Integrated with Power BJT and OTP

9 Functional Block Diagram

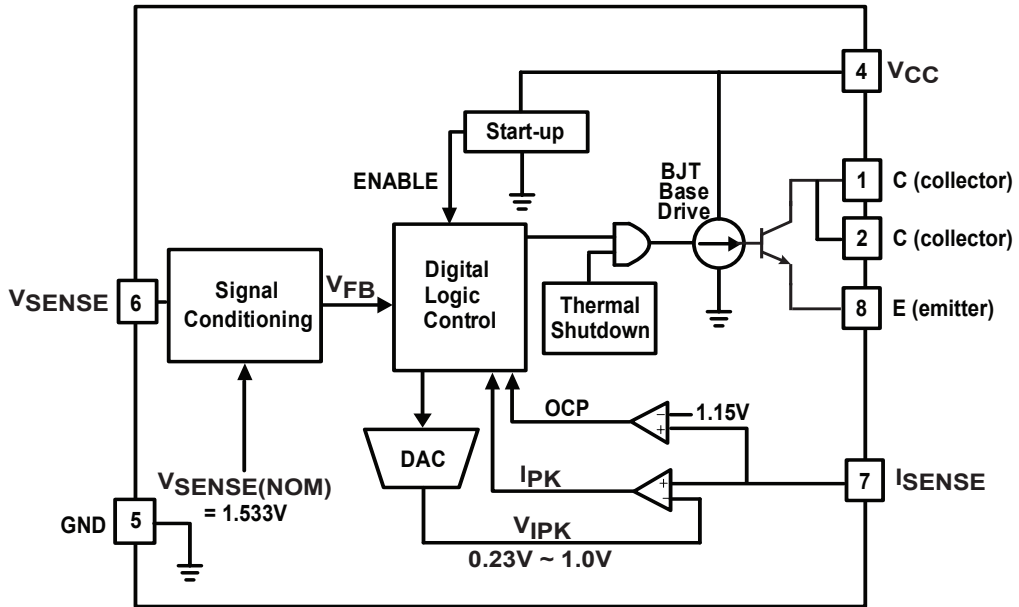

Figure 9.1 : iW1816 Functional Block Diagram

Off-Line Digital Green-Mode PWM Controller Integrated with Power BJT and OTP

10 Theory of Operation

The iW1816 is a digital controller integrated with a power BJT. It uses a proprietary primary-side control technology to eliminate the opto-isolated feedback and secondary regulation circuits required in traditional designs. This provides a low-cost solution for low power AC/DC adapters. The core PWM processor uses fixed-frequency Discontinuous Conduction Mode (DCM) operation at higher power levels and switches to variable frequency operation at light loads to maximize efficiency. Furthermore, Dialog's digital control technology enables fast dynamic response, tight output regulation, and full-featured circuit protection with primary-side control.

The block diagram in Figure 9.1 shows the digital logic control block generates the switching on-time and off-time information based on the output voltage and current feedback signal and provides instructions to dynamically control the internal BJT base current. The I_{SENSE} is an analog input configured to sense the primary current in a voltage form. In order to achieve the peak current mode control and cycle-by-cycle current limit, the V_{IPK} sets the threshold for the I_{SENSE} to compare with, and it varies in the range of 0.23V (typical) and 1.00V (typical) under different line and load conditions. The system loop is automatically compensated internally by a digital error amplifier. Adequate system phase margin and gain margin are guaranteed by design and no external analog components are required for loop compensation. The iW1816 uses an advanced digital control algorithm to reduce system design time and increase reliability.

Furthermore, accurate secondary constant-current operation is achieved without the need for any secondary-side sense and control circuits.

The iW1816 uses adaptive multi-mode PWM/PFM control to dynamically change the BJT switching frequency for efficiency, EMI, and power consumption optimization. In addition, it achieves unique BJT quasi-resonant switching to further improve efficiency and reduce EMI. The built-in single-point fault protection features include over-voltage protection (OVP), output-short-circuit protection (SCP), over-current protection (OCP), and I_{SENSE} fault detection.

Dialog's digital control scheme is specifically designed to address the challenges and trade-offs of power conversion design. This innovative technology is ideal for balancing new regulatory requirements for green mode operation with more practical design considerations such as the lowest possible cost, smallest size and high performance output control.

10.1 Pin Detail

Pin 1 and Pin 2 - C

Collector pin of the internal power BJT.

Pin 4 – V_{CC}

Power supply for the controller during normal operation. The controller will start up when V_{CC} reaches 11.0V (typical) and will shut-down when the V_{CC} voltage is 4.0V (typical). A decoupling capacitor should be connected between the V_{CC} pin and GND.

Pin 5 – GND

Ground.

Pin 6 – V_{SENSE}

Sense signal input from auxiliary winding. This provides the secondary voltage feedback used for output regulation.

Off-Line Digital Green-Mode PWM Controller Integrated with Power BJT and OTP

Pin 7 – I_{SENSE}

Primary current sense. It is used for cycle-by-cycle peak current control and limit.

Pin 8 – E

Emitter pin of the internal power BJT. This pin must be shorted to pin 7 (the I_{SENSE} pin).

10.2 Adaptively Controlled Soft Start-up

The iW1816 features an innovative proprietary soft-start scheme to achieve fast yet smooth start-up with a wide range of output loads, including capacitive loads typically from 330 μ F to 6,000 μ F, and for output voltage covering typically from 5V to 12V. Prior to start-up, the V_{CC} pin is charged typically through start-up resistors. When V_{CC} bypass capacitor is fully charged to a voltage higher than the start-up threshold V_{CC(ST)}, the ENABLE signal becomes active to enable the control logic, and the iW1816 begins to perform initial over-temperature protection check. When the internal die junction temperature is below 100°C, the iW1816 commences soft-start function. During the soft-start process, the primary-side peak current is limited cycle by cycle by the I_{PEAK} comparator. The whole soft-start process can break down into several stages based on the output voltage levels, which is indirectly sensed by V_{SENSE} signal at the primary side. At different stages, the iW1816 adaptively controls the switching frequency and primary-side peak current such that the output voltage can always build up very fast at the early stages and smoothly transition to the desired regulation voltage at the final stage, regardless of any capacitive and resistive loads that the applications may incur. With a lowest system cost, this adaptively controlled soft start-up feature makes the iW1816 ideal in applications with 12V output or large capacitive loads such as home appliances and ADSL modems.

If at any time the V_{CC} voltage drops below V_{CC(UVL)} threshold then all the digital logic is reset. At this time the ENABLE signal becomes low and the V_{CC} capacitor is charged up again towards the start-up threshold.

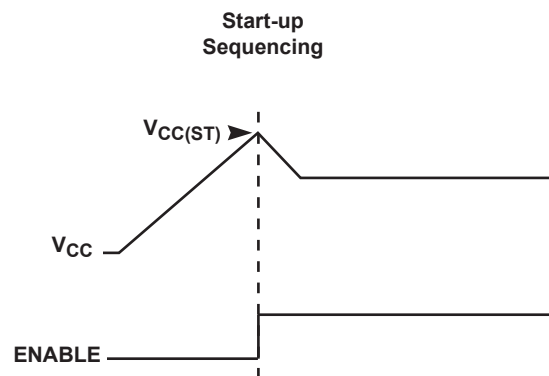

Figure 10.1 : Start-up Sequencing Diagram

10.3 Understanding Primary Feedback

Figure 10.2 illustrates a simplified flyback converter. When the switch Q1 conducts during t_{ON}(t), the current i_g(t) is directly drawn from the rectified sinusoid v_g(t). The energy E_G(t) is stored in the magnetizing inductance L_M. The rectifying diode D1 is reverse biased and the load current I_O is supplied by the secondary capacitor C_O. When Q1 turns off, D1 conducts and the stored energy E_g(t) is delivered to the output.

Off-Line Digital Green-Mode PWM Controller Integrated with Power BJT and OTP

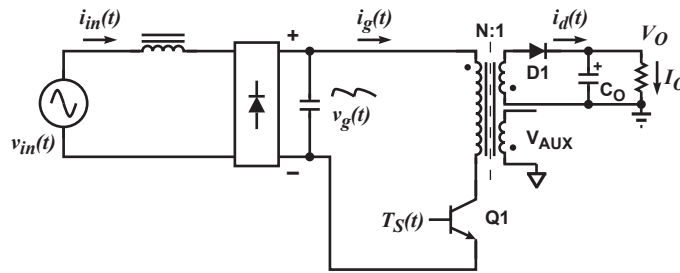

Figure 10.2 : Simplified Flyback Converter

In order to tightly regulate the output voltage, accurate information about the output voltage and load current must be accurately conveyed. In the DCM flyback converter, this information can be read via the auxiliary winding or the primary magnetizing inductance (L_M). During the Q1 on-time, the load current is supplied from the output filter capacitor C_O . The voltage across L_M is $v_g(t)$, if the voltage dropped across Q1 is zero. The current in Q1 ramps up linearly at a rate of:

$$\frac{di_g(t)}{dt} = \frac{v_g(t)}{L_M} \tag{10.1}$$

At the end of on-time, the current ramps up to:

$$i_{g_peak}(t) = \frac{v_g(t) \times t_{ON}}{L_M} \tag{10.2}$$

This current represents a stored energy of:

$$E_g = \frac{L_M}{2} \times i_{g_peak}(t)^2 \tag{10.3}$$

When Q1 turns off at t_O , $i_g(t)$ in L_M forces a reversal of polarities on all windings. Ignoring the communication-time caused by the leakage inductance L_K at the instant of turn-off t_O , the primary current transfers to the secondary at a peak amplitude of:

$$i_d(t) = \frac{N_P}{N_S} \times i_{g_peak}(t) \tag{10.4}$$

Assuming the secondary winding is master, and the auxiliary winding is slave,

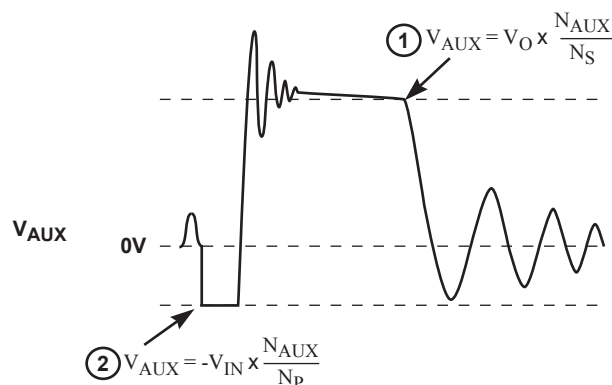

Figure 10.3 : Auxiliary Voltage Waveforms

Off-Line Digital Green-Mode PWM Controller Integrated with Power BJT and OTP

The auxiliary voltage is given by:

$$V_{AUX} = \frac{N_{AUX}}{N_S} (V_O + \Delta V) \quad (10.5)$$

and reflects the output voltage as shown in Figure 10.3.

The voltage at the load differs from the secondary voltage by a diode drop and IR losses. Therefore, if the secondary voltage is always read at a constant secondary current, the difference between the output voltage and the secondary voltage is a fixed ΔV . Furthermore, if the voltage can be read when the secondary current is small, ΔV is also small. With the iW1816, ΔV can be ignored.

The real-time waveform analyzer in the iW1816 reads this information cycle by cycle. The part then generates a feedback voltage V_{FB} . The V_{FB} signal accurately represents the output voltage under most circumstances and is used to regulate the output voltage.

10.4 Constant Voltage Operation

After soft-start is completed, the digital control block measures the output conditions. It determines the output power levels and adjusts the control system according to either a light or a heavy load. If this is in the normal range, the device operates in the Constant Voltage (CV) mode, and changes the pulse width (T_{ON}) and off-time (T_{OFF}) in order to meet the output voltage regulation requirements.

If no voltage is detected on V_{SENSE} , it is assumed that the auxiliary winding of the transformer is either open or shorted and the iW1816 shuts down.

10.5 Constant Current Operation

At overload condition, the iW1816 enters constant current (CC) mode to limit the output current on cycle-by-cycle basis. During this mode of operation the output current is limited to a constant level regardless of the output voltage, while avoiding continuous conduction mode operation. In case of very heavy loading, when the output voltage is low enough, the iW1816 shuts down.

To achieve this regulation the iW1816 senses the load current indirectly through the primary current. The primary current is detected by the I_{SENSE} pin through a resistor from the BJT emitter to ground.

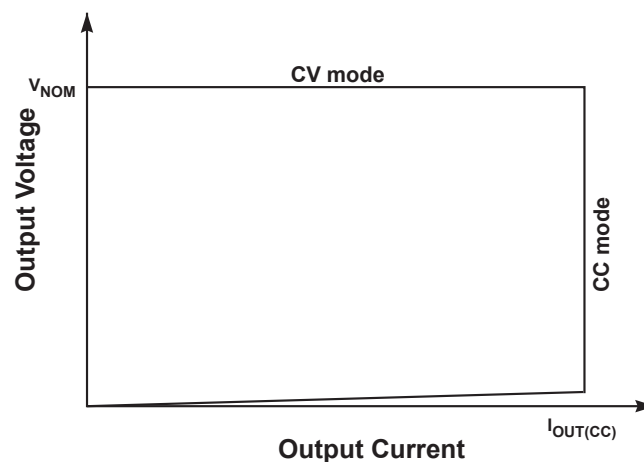

Figure 10.4 : Power Envelope

Off-Line Digital Green-Mode PWM Controller Integrated with Power BJT and OTP

10.6 Multi-Mode PWM/PFM Control and Quasi-Resonant Switching

The iW1816 uses a proprietary adaptive multi-mode PWM/PFM control to dramatically improve the light-load efficiency and thus the overall average efficiency.

During the constant voltage (CV) operation, the iW1816 normally operates in a pulse-width-modulation (PWM) mode in heavy load conditions. In the PWM mode, the switching frequency keeps around constant. As the output load I_{OUT} is reduced, the on-time t_{ON} is decreased, and the controller adaptively transitions to a pulse-frequency-modulation (PFM) mode. When in the PFM mode, the BJT is turned on for a set duration under a given instantaneous rectified AC input voltage, but its off-time is modulated by the load current. With a decreasing load current, the off-time increases and thus the switching frequency decreases.

When the switching frequency approaches to human ear audio band, the iW1816 transitions to a second level of PWM mode, namely Deep PWM mode (DPWM). In the DPWM mode, the switching frequency keeps around 22kHz in order to avoid audible noise. As the load current is further reduced, the iW1816 transitions to a second level of PFM mode, namely Deep PFM mode (DPFM), which can reduce the switching frequency to a very low level. Although the switching frequency drops across the audible frequency range in the DPFM mode, the output current in the power converter has reduced to an insignificant level in the DPWM mode before transitioning to the DPFM mode. Therefore the power converter practically produces no audible noise, while achieving high efficiency across varying load conditions.

As the load current reduces to a very low or no-load condition, the iW1816 transitions from the DPFM to the third level of PWM mode, namely Deep-Deep PWM mode (DDPWM), where the switching frequency is fixed at around 1.9kHz.

The iW1816 also incorporates a unique proprietary quasi-resonant switching scheme that achieves valley-mode turn-on for every PWM/PFM switching cycle, in all PFM and PWM modes, and in both CV and CC operations. This unique feature greatly reduces the switching loss and dv/dt across the entire operating range of the power supply. Due to the nature of quasi-resonant switching, the actual switching frequency can vary slightly cycle by cycle, providing the additional benefit of reducing EMI. Together these innovative digital control architecture and algorithms enable the iW1816 to achieve the highest overall efficiency and lowest EMI, without causing audible noise over entire operating range.

10.7 Less Than 30mW No-Load Power with Fast Load Transient Response

The iW1816 features the distinctive DDPWM control at no-load conditions to help achieve very low no-load power consumption (< 30mW for typical applications) and meanwhile to ensure fast dynamic load response. The power supply system designs including the pre-load resistor selection should ensure the power supply can stably operate in the DDPWM mode at the steady-state no-load condition. If the pre-load resistor is too small, the no-load power consumption will increase; on the other hand, if it is too large, the output voltage may increase and even cause over-voltage since the switching frequency is fixed at around 1.9kHz. For typical designs with 12V output, the pre-load resistor is in the range of 25k Ω to 50k Ω .

Aside from the appropriate use of pre-load resistor, the iW1816 enjoys a few other features to bring down no-load power consumption as well. First, the iW1816 implements an intelligent low-power management technique that achieves ultra-low chip operating current at the no-load, typically less than 400 μ A. Second, the use of the power switch of BJT instead of MOSFET requires a lower driving voltage, enabling a low UVLO threshold as low as 4.0V (typical). The power supply system design can fully utilize this low UVLO feature to have a low V_{CC} voltage at the no-load operation in order to minimize the no-load power. In addition, the ultra-low start-up current during the ramp-up of V_{CC} towards the start-up threshold $V_{CC(ST)}$ (see Figure 8.5), allows for the use of high resistance start-up resistors to minimize their loss while still retaining reasonable turn-on time. All together these features ensure that with the lowest system cost, power supplies built with the iW1816 can achieve less than 30mW no-load power consumption at 230 V_{AC} input and very tight constant voltage and constant current regulation over the entire operating range including the no-load operation.

Off-Line Digital Green-Mode PWM Controller Integrated with Power BJT and OTP

While achieving super-low no-load power consumption, the iW1816 implements innovative proprietary digital control technology to intelligently detect any load transient events, and achieve fast dynamic load response for both one-time and repetitive load transients. In particular, for load transients that are demanded in some applications as from absolutely no load to full load, the iW1816 can still guarantee a fast enough response to meet the most stringent requirements, with the no-load operating frequency designed at around 1.9kHz.

10.8 Variable Frequency Operation Mode

During each of the switching cycles, the falling edge of V_{SENSE} is checked. If the falling edge of V_{SENSE} is not detected, the off-time is extended until the falling edge of V_{SENSE} is detected. The maximum transformer reset time allowed is 125 μ s. When the transformer reset time reaches 125 μ s, the iW1816 shuts off.

10.9 Internal Loop Compensation

The iW1816 incorporates an internal Digital Error Amplifier with no requirement for external loop compensation. For a typical power supply design, the loop stability is guaranteed to provide at least 45 degrees of phase margin and -20dB of gain margin.

10.10 Voltage Protection Features

The secondary maximum output DC voltage is limited by the iW1816. When the V_{SENSE} signal exceeds the output OVP threshold at point 1 (as shown in Figure 10.3), the iW1816 shuts down.

The iW1816 protects against input line under-voltage by setting a maximum T_{ON} time. Since output power is proportional to the squared $V_{\text{IN}}T_{\text{ON}}$ product, for a given output power, the T_{ON} increases as the V_{IN} decreases. Thus by knowing when the maximum T_{ON} time occurs, the iW1816 detects that the minimum V_{IN} is reached, and then it shuts down. The maximum t_{ON} limit is set to 15.6 μ s. Also, the iW1816 monitors the voltage on the V_{CC} pin and when the voltage on this pin is below UVLO threshold the IC shuts down immediately.

When any of these faults is met the IC remains biased to discharge the V_{CC} supply. Once V_{CC} drops below the UVLO threshold, the controller resets itself and then initiates a new soft-start cycle. The controller continues attempting start-up until the fault condition is removed.

10.11 PCL, OCP and SRS Protection

The peak-current limit (PCL), over-current protection (OCP) and sense-resistor short protection (SRSP) are built-in features in the iW1816. With the I_{SENSE} pin the iW1816 is able to monitor the peak primary current. This allows for cycle-by-cycle peak current control and limit. When the peak primary current multiplied by the I_{SENSE} resistor is greater than 1.15V, over-current protection (OCP) is detected and the IC immediately turns off the base driver until the next cycle. The output driver sends out a switching pulse in the next cycle, and the switching pulse continues if the OCP threshold is not reached; or, the switching pulse turns off again if the OCP threshold is reached. If the OCP occurs for several consecutive switching cycles, the iW1816 shuts down.

If the I_{SENSE} resistor is shorted, there is a potential danger that the over-current condition is not detected. Thus, the IC is designed to detect this sense-resistor-short fault after start-up and immediate shutdown. The V_{CC} is discharged since the IC remains biased. Once the V_{CC} drops below the UVLO threshold, the controller resets itself and then initiates a new soft-start cycle. The controller continues attempting to start up, but does not fully start up until the fault condition is removed.

10.12 Dynamic Base Current Control

An important feature of the iW1816 is that it directly drives an internal BJT switching device with dynamic base current control to optimize performance. The BJT base current ranges from 10mA to 31mA, and is dynamically controlled according to the power supply load change. The higher the output power, the higher the base current. Specifically, the base current is related to V_{IPK} , as shown in Figure 10.5.

Off-Line Digital Green-Mode PWM Controller Integrated with Power BJT and OTP

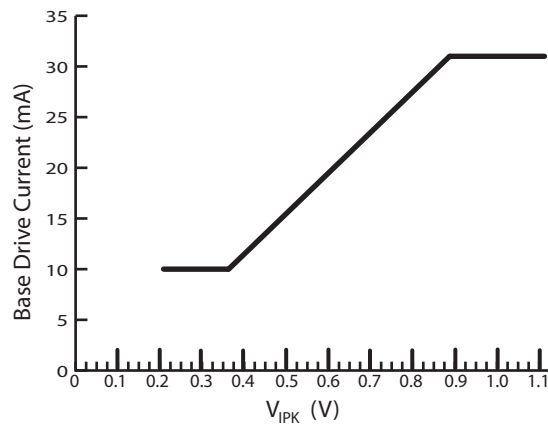

Figure 10.5 : Base Drive Current vs. V_{IPK}

10.13 Internal Over-Temperature Protection

The iW1816 features an internal over-temperature protection (OTP), which will shut down the device if the internal die junction temperature reaches above 150°C (typical). The device will be kept off until the junction temperature drops below 100°C (typical), when the device initiates a new soft-start process to build up the output voltage.

10.14 Thermal Design

The iW1816 may be installed inside a small enclosure, where space and air volumes are constrained. Under these circumstances θ_{JA} (thermal resistance, junction-to-ambient) measurements do not provide useful information for this type of application. Hence we have also provided ψ_{JB} which estimates the increase in die junction temperature relative to the PCB surface temperature. Figure 10.6 shows the PCB surface temperature is measured at the IC's GND pin pad.

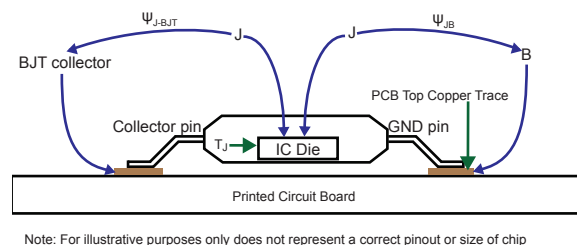

Figure 10.6 : Thermal Resistance

The actual IC power dissipation is related to the power supply application circuit, component selection and operation conditions. The maximum IC power dissipation should be used to estimate the maximum junction temperature. For a typical 3-W power supply, the power dissipation can be around 500mW.

The output power table in Section 3.0 recommends maximum practical continuous output power level be achieved under the following conditions:

- Typical 5V-output power supply designs with a Schottky rectifier diode
- Ambient temperature of 50°C for open frame and adapter enclosure internal temperature of 60°C in a non-ventilated environment
- AC Input voltage is 85V_{AC} at 47Hz

Off-Line Digital Green-Mode PWM Controller Integrated with Power BJT and OTP

- Minimum bulk capacitor voltage is 90V for open frame and 70V for adapter
- The iW1816 device is mounted on PCB with no special enhancement for heatsinking and the emitter pin temperature is kept below 90°C

Under a given power dissipation, reducing the GND, emitter, and collector pin temperature reduces the junction temperature. Generally, increasing the PCB area and associated amount of copper trace reduces the junction temperature. In particular, the power BJT is a power source and therefore the PCB plating area attached to the two collector pins and the emitter pin can be reasonably large to gain the thermal benefits without violating the high voltage creepage requirements if higher output power is desired. Higher output power is also achievable if bulk capacitor voltage is higher, design is for high line only, design components temperature restriction limit is higher, ambient temperature is lower, or extra metal piece/heat spreader is attached to related pins or package.

Off-Line Digital Green-Mode PWM Controller Integrated with Power BJT and OTP

11 Physical Dimensions

7-Lead Small Outline (SOIC) Package

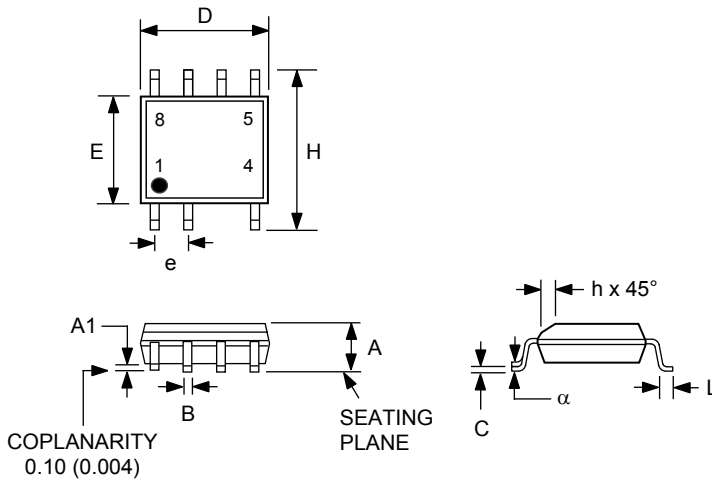

Symbol	Inches		Millimeters	
	MIN	MAX	MIN	MAX
A	0.060	0.068	1.52	1.73
A1	0.004	0.008	0.10	0.20
B	0.014	0.018	0.36	0.46
C	0.007	0.010	0.18	0.25
D	0.188	0.197	4.78	5.00
E	0.150	0.157	3.81	3.99
e	0.050 BSC		1.270 BSC	
H	0.230	0.244	5.84	6.20
h	0.010	0.016	0.25	0.41
L	0.023	0.029	0.58	0.74
α	0°	8°		

Compliant to JEDEC Standard MS12F

Controlling dimensions are in inches; millimeter dimensions are for reference only

This product is RoHS compliant and Halide free.

Soldering Temperature Resistance:

[a] Package is IPC/JEDEC Std 020D Moisture Sensitivity Level 1

[b] Package exceeds JEDEC Std No. 22-A111 for Solder Immersion Resistance; package can withstand 10 s immersion < 270°C

Dimension D does not include mold flash, protrusions or gate burrs. Mold flash, protrusions or gate burrs shall not exceed 0.15 mm per end. Dimension E1 does not include interlead flash or protrusion. Interlead flash or protrusion shall not exceed 0.25 mm per side.

The package top may be smaller than the package bottom. Dimensions D and E1 are determined at the outermost extremes of the plastic body exclusive of mold flash, tie bar burrs, gate burrs and interlead flash, but including any mismatch between the top and bottom of the plastic body.

12 Ordering Information

Part No.	Package	Description
iW1816-20-SO7	SOIC-7	Tape & Reel ¹

Note 1: Tape and reel packing quantity is 2,500/reel. Minimum ordering quantity is 2,500.

Off-Line Digital Green-Mode PWM Controller Integrated with Power BJT and OTP

Disclaimer

Information in this document is believed to be accurate and reliable. However, Dialog Semiconductor does not give any representations or warranties, expressed or implied, as to the accuracy or completeness of such information. Dialog Semiconductor furthermore takes no responsibility whatsoever for the content in this document if provided by any information source outside of Dialog Semiconductor.

Dialog Semiconductor reserves the right to change without notice the information published in this document, including without limitation the specification and the design of the related semiconductor products, software and applications.

Applications, software, and semiconductor products described in this document are for illustrative purposes only. Dialog Semiconductor makes no representation or warranty that such applications, software and semiconductor products will be suitable for the specified use without further testing or modification. Unless otherwise agreed in writing, such testing or modification is the sole responsibility of the customer and Dialog Semiconductor excludes all liability in this respect.

Customer notes that nothing in this document may be construed as a license for customer to use the Dialog Semiconductor products, software and applications referred to in this document. Such license must be separately sought by customer with Dialog Semiconductor.

All use of Dialog Semiconductor products, software and applications referred to in this document are subject to [Dialog Semiconductor's Standard Terms and Conditions of Sale](#), available on the company website (www.dialog-semiconductor.com) unless otherwise stated.

Dialog and the Dialog logo are trademarks of Dialog Semiconductor plc or its subsidiaries. All other product or service names are the property of their respective owners.

© 2016 Dialog Semiconductor. All rights reserved.

RoHS Compliance

Dialog Semiconductor's suppliers certify that its products are in compliance with the requirements of Directive 2011/65/EU of the European Parliament on the restriction of the use of certain hazardous substances in electrical and electronic equipment. RoHS certificates from our suppliers are available on request.

Contacting Dialog Semiconductor

United Kingdom (Headquarters)
Dialog Semiconductor (UK) LTD
Phone: +44 1793 757700

Germany
Dialog Semiconductor GmbH
Phone: +49 7021 805-0

The Netherlands
Dialog Semiconductor B.V.
Phone: +31 73 640 8822

Email
info_pcbg@diasemi.com

North America
Dialog Semiconductor Inc.
Phone: +1 408 845 8500

Japan
Dialog Semiconductor K. K.
Phone: +81 3 5425 4567

Taiwan
Dialog Semiconductor Taiwan
Phone: +886 281 786 222

Web site:
www.dialog-semiconductor.com

Singapore
Dialog Semiconductor Singapore
Phone: +65 64 8499 29

Hong Kong
Dialog Semiconductor Hong Kong
Phone: +852 3769 5200

Korea
Dialog Semiconductor Korea
Phone: +82 2 3469 8200

China (Shenzhen)
Dialog Semiconductor China
Phone: +86 755 2981 3669

China (Shanghai)
Dialog Semiconductor China
Phone: +86 21 5424 9058