

High Voltage BIMOSFET™

in High Voltage ISOPLUS i4-PAC™

Monolithic Bipolar MOS Transistor

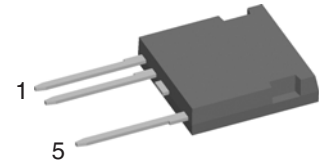
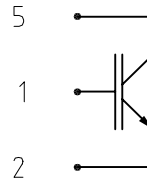

$$I_{C25} = 7 \text{ A}$$

$$V_{CES} = 1600 \text{ V}$$

$$V_{CE(sat)} = 4.9 \text{ V}$$

$$t_f = 70 \text{ ns}$$

IGBT		
Symbol	Conditions	Maximum Ratings
V_{CES}	$T_{VJ} = 25^\circ\text{C to } 150^\circ\text{C}$	1600 V
V_{GES}		± 20 V
I_{C25}	$T_C = 25^\circ\text{C}$	7 A
I_{C90}	$T_C = 90^\circ\text{C}$	4 A
I_{CM} V_{CEK}	$V_{GE} = 10/0 \text{ V}; R_G = 27 \Omega; T_{VJ} = 125^\circ\text{C}$ RBSOA, Clamped inductive load; $L = 100 \mu\text{H}$	12 A $0.8 \cdot V_{CES}$
P_{tot}	$T_C = 25^\circ\text{C}$	70 W

Features

- High Voltage BIMOSFET™
 - substitute for high voltage MOSFETs with significantly lower voltage drop
 - MOSFET compatible control 10 V turn on gate voltage
 - fast switching for high frequency operation
 - reverse conduction capability
- ISOPLUS i4-PAC™ high voltage package
 - isolated back surface
 - enlarged creepage towards heatsink
 - enlarged creepage between high voltage pins
 - application friendly pinout
 - high reliability
 - industry standard outline

Symbol	Conditions	Characteristic Values ($T_{VJ} = 25^\circ\text{C}$, unless otherwise specified)		
		min.	typ.	max.
$V_{CE(sat)}$	$I_C = 5 \text{ A}; V_{GE} = 15 \text{ V}; T_{VJ} = 25^\circ\text{C}$ $T_{VJ} = 125^\circ\text{C}$		4.9 5.6	7 V V
$V_{GE(th)}$	$I_C = 0.5 \text{ mA}; V_{GE} = V_{CE}$	3.5		5.5 V
I_{CES}	$V_{CE} = 0.8V_{CES}; V_{GE} = 0 \text{ V}; T_{VJ} = 25^\circ\text{C}$ $T_{VJ} = 125^\circ\text{C}$		0.1	0.1 mA mA
I_{GES}	$V_{CE} = 0 \text{ V}; V_{GE} = \pm 20 \text{ V}$			500 nA
$t_{d(on)}$ t_r $t_{d(off)}$ t_f	Inductive load, $T_{VJ} = 125^\circ\text{C}$ $V_{CE} = 960 \text{ V}; I_C = 5 \text{ A}$ $V_{GE} = 10/0 \text{ V}; R_G = 27 \Omega$		140 200 120 70	ns ns ns ns
C_{ies}		$V_{CE} = 25 \text{ V}; V_{GE} = 0 \text{ V}; f = 1 \text{ MHz}$		550 pF
Q_{Gon}		$V_{CE} = 600 \text{ V}; V_{GE} = 10 \text{ V}; I_C = 5 \text{ A}$		34 nC
V_F		(reverse conduction); $I_F = 5 \text{ A}$		3.6
R_{thJC}				1.75 KW

Applications

- switched mode power supplies
- DC-DC converters
- resonant converters
- lamp ballasts
- laser generators, x ray generators

Component

Symbol	Conditions	Maximum Ratings	
T_{VJ}		-55...+150	°C
T_{stg}		-55...+125	°C
V_{ISOL}	$I_{ISOL} \leq 1 \text{ mA}; 50/60 \text{ Hz}$	2500	V~
F_c	mounting force with clip	20...120	N

Symbol	Conditions	Characteristic Values		
		min.	typ.	max.
d_S, d_A	pin 2 - pin 5	7		mm
d_S, d_A	pin - backside metal	5.5		mm
R_{thCH}	with heatsink compound		0.15	K/W
Weight			9	g

Dimensions in mm (1 mm = 0.0394")

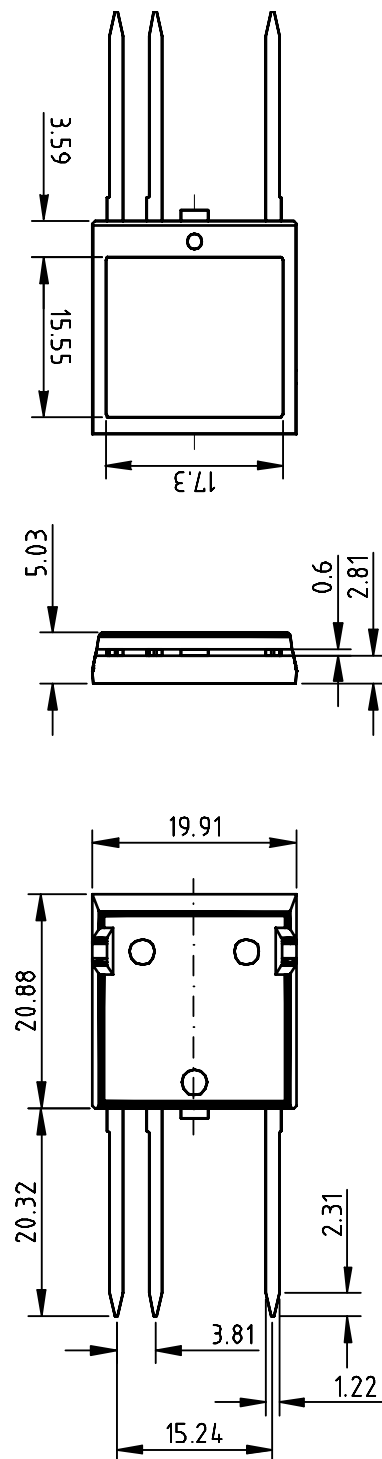

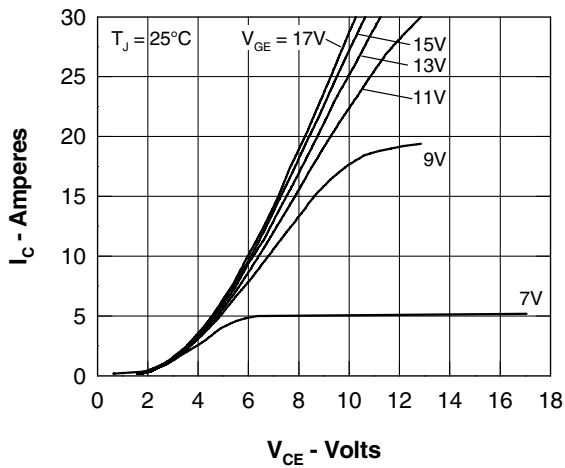

Fig. 1 Typ. Output Characteristics

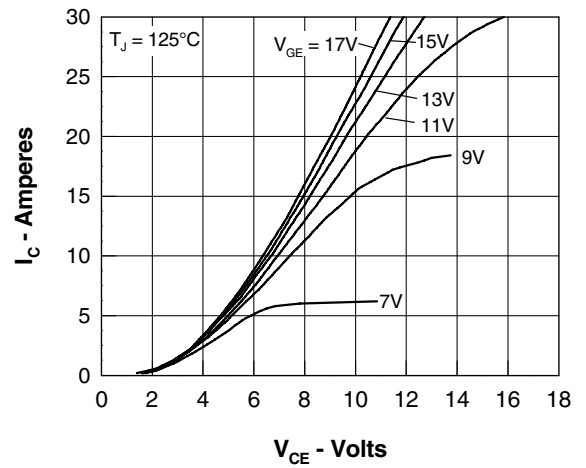

Fig. 2 Typ. Output Characteristics

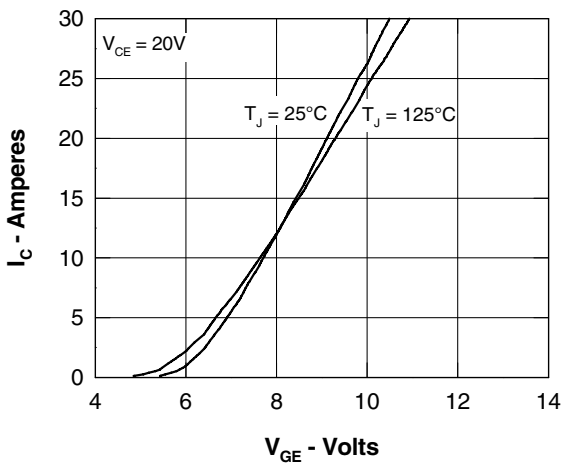

Fig. 3 Typ. Transfer Characteristics

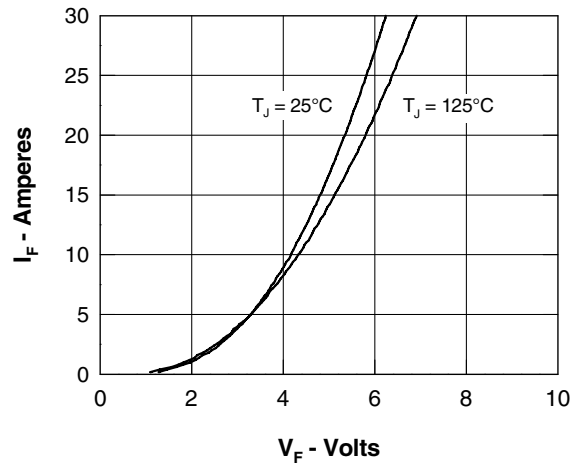

Fig. 4 Typ. Characteristics of Reverse Conduction

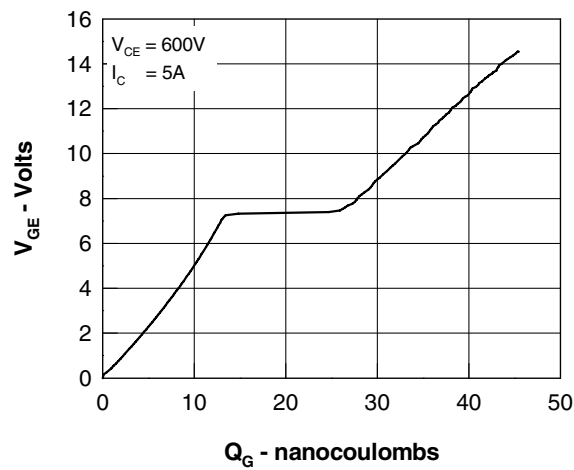

Fig. 5 Typ. Gate Charge characteristics

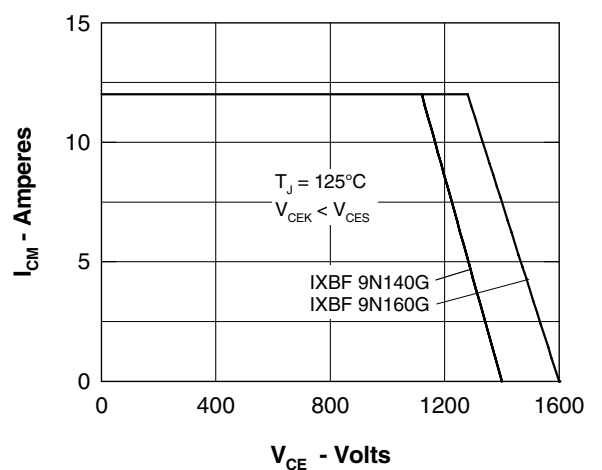

Fig. 6 Reverse Biased Safe Operating Area RBSOA

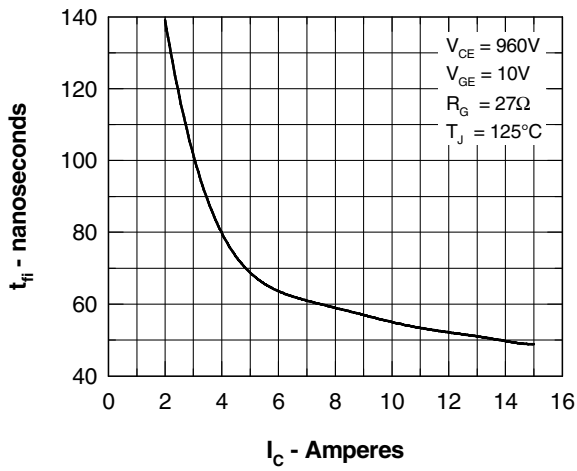

Fig. 7 Typ. Fall Time

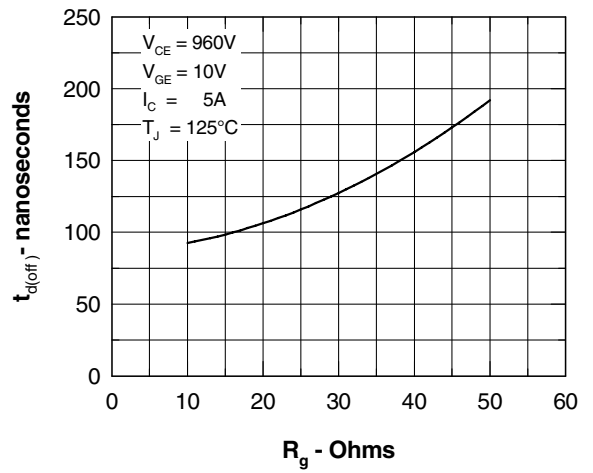

Fig. 8 Typ. Turn Off Delay Time

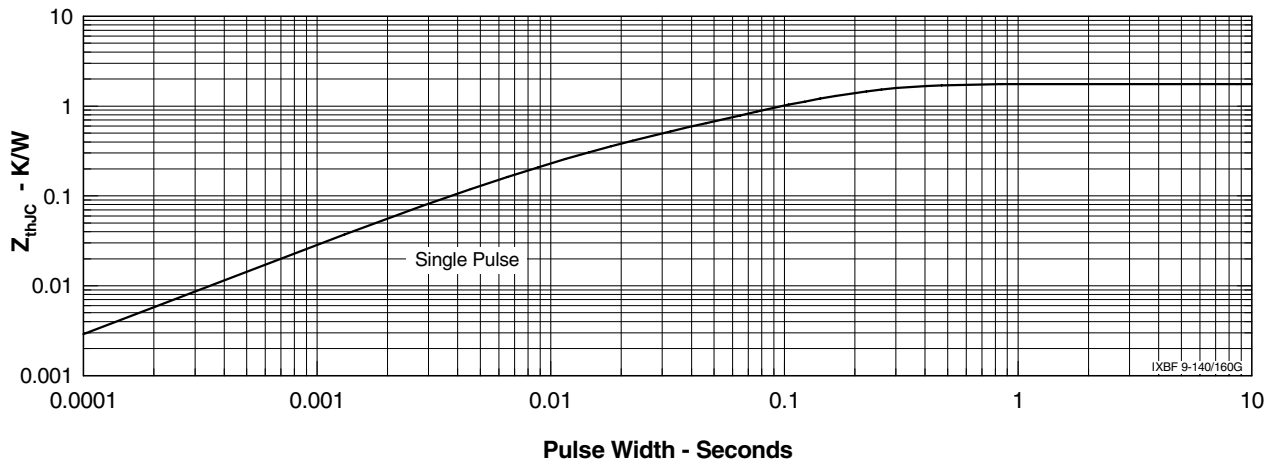

Fig. 9 Typ. Transient Thermal Impedance