

High Speed LDO Regulator with ON/OFF Control

FEATURES

- Output Current up to 150 mA (300 mA for IXD2109E/H type)
- Output Voltage Range from 0.9 V to 6.0 V with 0.05 V increments
- Output Voltage Accuracy $\pm 2\%$ (at $V_{OUT} > 1.5$ V), ± 30 mV (at $V_{OUT} \leq 1.5$ V)
- Dropout Voltage 60 mV @ 30 mA , 0.20 V @ 100 mA
- Maximum Operating Voltage 10 V
- Low Power Consumption at 25 μ A typical
- Standby Current less than 0.1 μ A typical
- Ripple Rejection 70 dB at 10 kHz
- Low ESR Ceramic Capacitor compatible
- Operating Ambient Temperature - 40 + 85°C
- Packages : SOT-25, SOT-89-5 , and USP-6B
- EU RoHS Compliant, Pb Free

APPLICATIONS

- Mobile phones
- Cameras, VCRs
- Various portable equipment
- Reference voltage source

TYPICAL APPLICATION CIRCUIT

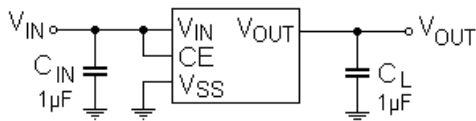

DESCRIPTION

The IXD1209/12 are a highly precise, low noise, positive voltage LDO regulators manufactured using CMOS processes. The IXD1209/12 have a high ripple rejection factor and low dropout. They consist of a voltage reference, an error amplifier, a current limiter, a phase compensation circuit, and a driver transistor.

Output voltage is selectable in 0.05V increments within a range of 0.9 V ~ 6.0 V.

The IXD1209/12 are compatible with low ESR ceramic capacitors, and due excellent transient response, they maintain stability even during significant load fluctuations. The current limiter's foldback circuit operates also as a short circuit protection.

The chip enable (CE) function allows disable IC, greatly reducing power consumption.

Regulator is available in SOT-25, SOT-89-5, and USP-6B packages.

TYPICAL PERFORMANCE CHARACTERISTIC

Supply Current vs. Input Voltage (IXD1209/12 F122)

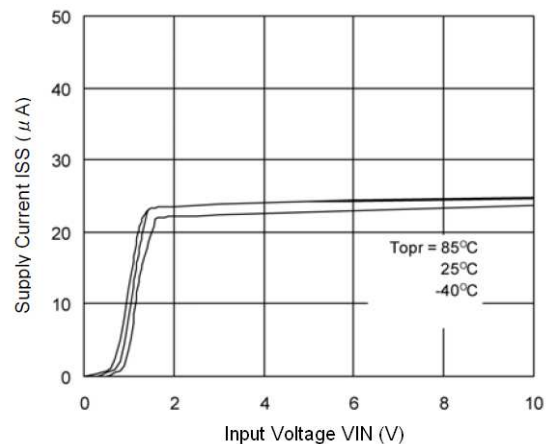

ABSOLUTE MAXIMUM RATINGS

PARAMETER		SYMBOL	RATINGS	UNITS
Input Voltage		V_{IN}	- 0.3 ~ 12.0	V
Output Current		I_{OUT}	500 ¹⁾	mA
Output Voltage		V_{OUT}	- 0.3 ~ $V_{IN} + 0.3$	V
CE Input Voltage		V_{CE}	- 0.3 ~ 12.0	V
Power Dissipation ²⁾	SOT-25	P_D	250 (600 PCB mounted)	mW
	SOT-89-5		500 (1300 PCB mounted)	
	USP-6C		120 (1000 PCB mounted)	
Operating Temperature Range		T_{OPR}	- 40 ~ + 85	°C
Storage Temperature Range		T_{STG}	- 55 ~ +125	°C

All voltages are in respect to V_{SS}

1) $I_{OUT} \leq Pd / (V_{IN} - V_{OUT})$

2) This is a reference data taken by using the test board. Please refer to page 21 to 23 for details.

ELECTRICAL OPERATING CHARACTERISTICS

IXD1209/12 Type A, B

$T_a = 25^\circ\text{C}$

PARAMETER		SYMBOL	CONDITIONS	MIN.	TYP.	MAX.	UNIT	CIRCUIT
Output Voltage (2%) ³⁾		$V_{OUT(E)}^{1)}$	$I_{OUT} = 30\text{ mA}$	$V_{OUT(T)} \times 0.98$	$V_{OUT(T)}^*$	$V_{OUT(T)} \times 1.02$	V	①
Output Voltage (1%) ⁴⁾				$V_{OUT(T)} \times 0.99$	$V_{OUT(T)}^*$	$V_{OUT(T)} \times 1.01$		
Maximum Output Current		I_{OUT_MAX}	$V_{IN} = 2.3\text{ V}, V_{OUT} \geq 1.17\text{ V}$	60			mA	①
Load Regulation		ΔV_{OUT}	$1\text{ mA} \leq I_{OUT} \leq 100\text{ mA}$		15	50	mV	①
Dropout Voltage ²⁾		V_{DIF1}	$I_{OUT} = 30\text{ mA}$		E-1		mV	①
		V_{DF2}	$I_{OUT} = 100\text{ mA}$		E-2			
Supply Current	Type A	I_{SS}	$V_{CE} = V_{IN} = V_{OUT(E)} + 1.0\text{ V}$ When $V_{OUT} \leq 0.95\text{ V}, V_{CE} = V_{IN} = 2.0\text{ V}$		28	55	μA	②
	Type B				25	50		
Standby Current		I_{STB}	$V_{CE} = 0\text{ V}$		0.01	0.10	μA	②
Line Regulation		$\frac{\Delta V_{OUT}}{V_{OUT} * \Delta V_{IN}}$	$V_{OUT(E)} + 1.0\text{ V} \leq V_{IN} \leq 10\text{ V}$ When $V_{OUT} \leq 0.95\text{ V}, 2.0\text{ V} \leq V_{IN} \leq 10\text{ V}$ $I_{OUT} = 30\text{ mA},$ When $V_{OUT} \leq 1.75\text{ V}, I_{OUT} = 10\text{ mA}$		0.01	0.20	%/V	①
Input Voltage		V_{IN}		2		10	V	
Output Voltage Temperature Characteristics		$\frac{\Delta V_{OUT}}{V_{OUT} * \Delta T_{OPR}}$	$I_{OUT} = 30\text{ mA}$ $- 40^\circ\text{C} \leq T_{OPR} \leq 85^\circ\text{C}$		± 100		ppm/°C	①
Power Supply Rejection Ratio		PSRR	$V_{IN} = (V_{OUT(E)} + 1.0\text{ V}) + 1\text{ Vp-p}_{AC}$ When $V_{OUT} \leq 1.5\text{ V},$ $V_{IN} = 2.5\text{ V} + 1.0\text{ Vp-p}_{AC},$ $I_{OUT} = 10\text{ mA}, f = 10\text{ kHz}$		70		dB	④
Current Limit		I_{LIM}	$V_{IN} = V_{OUT(E)} + 1.0\text{ V}, V_{CE} = 0\text{ V}$ When $V_{OUT} \leq 1.75\text{ V}, V_{IN} = V_{OUT(E)} + 2.0\text{ V}$		300		mA	①
Short Current		I_{SHORT}	$V_{CE} = 0\text{ V},$ When $V_{OUT} \leq 1.75\text{ V},$ $V_{IN} = V_{OUT(E)} + 2.0\text{ V}$		50		mA	①
CE "H" Level Voltage		V_{CEH}		1.6		V_{IN}	V	①
CE "L" Level Voltage		V_{CEL}				0.25	V	①
CE "H" Level Current	Type A	I_{CEH}	$V_{CE} = V_{IN} = V_{OUT(E)} + 1.0\text{ V}$ When $V_{OUT} \leq 0.95\text{ V}, V_{CE} = V_{IN} = 2.0\text{ V}$	0.8		5.0	μA	②
	Type B			-0.1		0.1		
CE "L" Level Current		I_{CEL}	$V_{CE} = 0\text{ V}, V_{IN} = V_{OUT(E)} + 1.0\text{ V}$ When $V_{OUT} \leq 0.95\text{ V}, V_{CE} = V_{IN} = 2.0\text{ V}$	-0.1		0.1	μA	②

NOTE:

- Unless otherwise stated, $V_{IN} = V_{OUT(T)} + 1.0\text{ V}$. If V_{OUT} is less than 0.95 V, $V_{IN} = 2.0\text{ V}$; $V_{OUT(T)}$ is Nominal output voltage and $V_{OUT(E)}$ is Effective output voltage, (i.e. the output voltage when " $V_{OUT(T)} + 1.0\text{V}$ " is provided at the V_{IN} pin, while maintaining a certain I_{OUT} value).
- $V_{DIF} = \{V_{IN} - V_{OUT}\}$, where V_{IN1} is the input voltage when $V_{OUT} = 0.98 V_{OUT(T)}$ appears, while input voltage gradually decreases
- If $V_{OUT(T)}$ is less than 1.45 V, MIN. = $V_{OUT(T)} - 30\text{ mV}$, MAX. = $V_{OUT(T)} + 30\text{ mV}$
- For products with $V_{OUT(T)} > 3.0\text{ V}$ only

ELECTRICAL OPERATING CHARACTERISTICS (CONTINUED)

IXD1209/12 Type C, D

T_a = 25 °C

PARAMETER		SYMBOL	CONDITIONS	MIN.	TYP.	MAX.	UNIT	CIRCUIT
Output Voltage (2%) ³⁾		V _{OUT(E)} ¹⁾	I _{OUT} = 30 mA	V _{OUT(T)} × 0.98	V _{OUT(T)} *	V _{OUT(T)} × 1.02	V	①
Output Voltage (1%) ⁴⁾				V _{OUT(T)} × 0.99	V _{OUT(T)} *	V _{OUT(T)} × 1.01		
Maximum Output Current		I _{OUT_MAX}	V _{IN} = 2.3 V, V _{OUT} ≥ 1.17 V	150			mA	①
Load Regulation		ΔV _{OUT1}	1 mA ≤ I _{OUT} ≤ 100 mA		15	50	mV	①
Dropout Voltage ²⁾		V _{DIF1}	I _{OUT} = 30 mA		E-1		mV	①
		V _{DF2}	I _{OUT} = 100mA		E-2			
Supply Current	Type C	I _{SS}	V _{CE} = V _{IN} = V _{OUT(E)} + 1.0 V When V _{OUT} ≤ 0.95 V, V _{CE} = V _{IN} = 2.0 V		28	55	μA	②
	Type D				25	50		
Standby Current		I _{STB}	V _{CE} = 0 V		0.01	0.10	μA	②
Line Regulation		$\frac{\Delta V_{OUT}}{V_{OUT} * \Delta V_{IN}}$	V _{OUT(E)} + 1.0 V ≤ V _{IN} ≤ 10 V When V _{OUT} ≤ 0.95 V, 2.0 V ≤ V _{IN} ≤ 10 V I _{OUT} = 30 mA, When V _{OUT} ≤ 1.75 V, I _{OUT} = 10 mA		0.01	0.20	%/V	①
Input Voltage		V _{IN}		2		10	V	
Output Voltage Temperature Characteristics		$\frac{\Delta V_{OUT}}{V_{OUT} * \Delta T_{OPR}}$	I _{OUT} = 30 mA - 40 °C ≤ T _{OPR} ≤ 85 °C		± 100		ppm/°C	①
Power Supply Rejection Ratio		PSRR	V _{IN} = (V _{OUT(E)} + 1.0 V) + 1 Vp-p _{AC} When V _{OUT} ≤ 1.5 V, V _{IN} = 2.5 V + 1.0 Vp-p _{AC} , I _{OUT} = 10 mA, f = 10 kHz		70		dB	④
Current Limit		I _{LIM}	V _{IN} = V _{OUT(E)} + 1.0 V, V _{CE} = 0 V When V _{OUT} ≤ 1.75 V, V _{IN} = V _{OUT(E)} + 2.0 V		300		mA	①
Short Current		I _{SHORT}	V _{CE} = 0 V, When V _{OUT} ≤ 1.75 V, V _{IN} = V _{OUT(E)} + 2.0 V		50		mA	①
CE "H" Level Voltage		V _{CEH}		1.6		V _{IN}	V	①
CE "L" Level Voltage		V _{CEL}				0.25	V	①
CE "H" Level Current		I _{CEH}	V _{CE} = V _{IN} = V _{OUT(E)} + 1.0 V When V _{OUT} ≤ 0.95 V, V _{CE} = V _{IN} = 2.0 V	-0.1		0.1	μA	②
CE "L" Level Current	Type C	I _{CEL}	V _{CE} = 0 V, V _{IN} = V _{OUT(E)} + 1.0 V When V _{OUT} ≤ 0.95 V, V _{CE} = V _{IN} = 2.0 V	-5.0		-0.8	μA	②
	Type D			-0.1		0.1		

NOTE:

- 1) Unless otherwise stated, V_{IN} = V_{OUT(T)} + 1.0 V. If V_{OUT} is less than 0.95 V, V_{IN} = 2.0 V; V_{OUT(T)} is Nominal output voltage and V_{OUT(E)} is Effective output voltage, (i.e. the output voltage when "V_{OUT(T)} + 1.0V" is provided at the V_{IN} pin, while maintaining a certain I_{OUT} value).
- 2) V_{DIF} = {V_{IN} - V_{OUT}}, where V_{IN1} is the input voltage when V_{OUT} = 0.98 V_{OUT(T)} appears, while input voltage gradually decreases
- 3) If V_{OUT(T)} is less than 1.45 V, MIN. = V_{OUT(T)} - 30 mV, MAX. = V_{OUT(T)} + 30 mV
- 4) For products with V_{OUT(T)} > 3.0 V only.

ELECTRICAL OPERATING CHARACTERISTICS (CONTINUED)

IXD1209/12 Type E, F

Ta = 25 °C

PARAMETER		SYMBOL	CONDITIONS	MIN.	TYP.	MAX.	UNIT	CIRCUIT
Output Voltage (2%) ³⁾		V _{OUT(E)} ¹⁾	I _{OUT} = 30 mA	V _{OUT(T)} × 0.98	V _{OUT(T)} *	V _{OUT(T)} × 1.02	V	①
Output Voltage (1%) ⁴⁾				V _{OUT(T)} × 0.99	V _{OUT(T)} *	V _{OUT(T)} × 1.01		
Maximum Output Current		I _{OUT_MAX}	V _{IN} = E-3 ⁵⁾	E-4			mA	①
Load Regulation		ΔV _{OUT1}	1 mA ≤ I _{OUT} ≤ 100 mA		15	50	mV	①
		ΔV _{OUT2}	1 mA ≤ I _{OUT} ≤ 300 mA			100		
Dropout Voltage ²⁾		V _{DIF1}	I _{OUT} = 30 mA		E-1		mV	①
		V _{DF2}	I _{OUT} = 100mA		E-2			
Supply Current	Type G	I _{SS}	V _{CE} = V _{IN} = V _{OUT(E)} + 1.0 V		28	55	μA	②
	Type H		When V _{OUT} ≤ 0.95 V, V _{CE} = V _{IN} = 2.0 V		25	50		
Standby Current		I _{STB}	V _{CE} = 0 V		0.01	0.10	μA	②
Line Regulation		$\frac{\Delta V_{OUT}}{V_{OUT} * \Delta V_{IN}}$	V _{OUT(E)} + 1.0 V ≤ V _{IN} ≤ 10 V When V _{OUT} ≤ 0.95 V, 2.0 V ≤ V _{IN} ≤ 10 V I _{OUT} = 30 mA, When V _{OUT} ≤ 1.75 V, I _{OUT} = 10 mA		0.01	0.20	%/V	①
Input Voltage		V _{IN}		2		10	V	
Output Voltage Temperature Characteristics		$\frac{\Delta V_{OUT}}{V_{OUT} * \Delta T_{OPR}}$	I _{OUT} = 30 mA - 40 °C ≤ T _{OPR} ≤ 85 °C		± 100		ppm/°C	①
Power Supply Rejection Ratio		PSRR	V _{IN} = (V _{OUT(E)} + 1.0 V) + 1 Vp-p _{PAC} When V _{OUT} ≤ 1.5 V, V _{IN} = 2.5 V + 1.0 Vp-p _{PAC} , I _{OUT} = 10 mA, f = 10 kHz		70		dB	④
Current Limit		I _{LIM}	V _{IN} = V _{OUT(E)} + 1.0 V, V _{CE} = 0 V When V _{OUT} ≤ 1.75 V, V _{IN} = V _{OUT(E)} + 2.0 V		380		mA	①
Short Current		I _{SHORT}	V _{CE} = 0 V, When V _{OUT} ≤ 1.75 V, V _{IN} = V _{OUT(E)} + 2.0 V		50		mA	①
CE "H" Level Voltage		V _{CEH}		1.6		V _{IN}	V	①
CE "L" Level Voltage		V _{CEL}				0.25	V	①
CE "H" Level Current	Type E	I _{CEH}	V _{CE} = V _{IN} = V _{OUT(E)} + 1.0 V	0.8		5.0	μA	②
	Type F		When V _{OUT} ≤ 0.95 V, V _{CE} = V _{IN} = 2.0 V	-0.1		0.1		
CE "L" Level Current		I _{CEL}	V _{CE} = 0 V, V _{IN} = V _{OUT(E)} + 1.0 V When V _{OUT} ≤ 0.95 V, V _{CE} = V _{IN} = 2.0 V	-0.1		0.1	μA	②

NOTE:

- 1) Unless otherwise stated, V_{IN} = V_{OUT(T)} + 1.0 V. If V_{OUT} is less than 0.95 V, V_{IN} = 2.0 V; V_{OUT(T)} is Nominal output voltage and V_{OUT(E)} is Effective output voltage, (i.e. the output voltage when "V_{OUT(T)} + 1.0V" is provided at the V_{IN} pin, while maintaining a certain I_{OUT} value).
- 2) V_{DIF} = {V_{IN}-V_{OUT}}, where V_{IN1} is the input voltage when V_{OUT} = 0.98 V_{OUT(T)} appears, while input voltage gradually decreases
- 3) If V_{OUT(T)} is less than 1.45 V, MIN. = V_{OUT(T)} - 30 mV, MAX. = V_{OUT(T)} + 30 mV
- 4) For products with V_{OUT(T)} > 3.0 V only
- 5) Refer to the "Dropout Voltage" table

ELECTRICAL OPERATING CHARACTERISTICS (CONTINUED)

IXD1209/12 Type G, H

Ta = 25 °C

PARAMETER		SYMBOL	CONDITIONS	MIN.	TYP.	MAX.	UNIT	CIRCUIT
Output Voltage (2%) ³⁾		V _{OUT(E)} ¹⁾	I _{OUT} = 30 mA	V _{OUT(T)} X 0.98	V _{OUT(T)} *	V _{OUT(T)} X 1.02	V	①
Output Voltage (1%) ⁴⁾				V _{OUT(T)} X 0.99	V _{OUT(T)} *	V _{OUT(T)} X 1.01		
Maximum Output Current		I _{OUT_MAX}	V _{IN} = E-3 ⁵⁾	E-4			mA	①
Load Regulation		ΔV _{OUT1}	1 mA ≤ I _{OUT} ≤ 100 mA		15	50	mV	①
		ΔV _{OUT2}	1 mA ≤ I _{OUT} ≤ 300 mA			100		
Dropout Voltage ²⁾		V _{DIF1}	I _{OUT} = 30 mA		E-1		mV	①
		V _{DF2}	I _{OUT} = 100mA		E-2			
Supply Current	Type G	I _{SS}	V _{CE} = V _{IN} = V _{OUT(E)} + 1.0 V When V _{OUT} ≤ 0.95 V, V _{CE} = V _{IN} = 2.0 V		28	55	μA	②
	Type H				25	50		
Standby Current		I _{STB}	V _{CE} = 0 V		0.01	0.10	μA	②
Line Regulation		$\frac{\Delta V_{OUT}}{V_{OUT} * \Delta V_{IN}}$	V _{OUT(E)} + 1.0 V ≤ V _{IN} ≤ 10 V When V _{OUT} ≤ 0.95 V, 2.0 V ≤ V _{IN} ≤ 10 V I _{OUT} = 30 mA, When V _{OUT} ≤ 1.75 V, I _{OUT} = 10 mA		0.01	0.20	%/V	①
Input Voltage		V _{IN}		2		10	V	
Output Voltage Temperature Characteristics		$\frac{\Delta V_{OUT}}{V_{OUT} * \Delta T_{OPR}}$	I _{OUT} = 30 mA - 40 °C ≤ T _{OPR} ≤ 85 °C		± 100		ppm/°C	①
Power Supply Rejection Ratio		PSRR	V _{IN} = (V _{OUT(E)} + 1.0 V) + 1 Vp-p _{AC} When V _{OUT} ≤ 1.5 V, V _{IN} = 2.5 V + 1.0 Vp-p _{AC} , I _{OUT} = 10 mA, f = 10 kHz		70		dB	④
Current Limit		I _{LIM}	V _{IN} = V _{OUT(E)} + 1.0 V, V _{CE} = 0 V When V _{OUT} ≤ 1.75 V, V _{IN} = V _{OUT(E)} + 2.0 V		380		mA	①
Short Current		I _{SHORT}	V _{CE} = 0 V, When V _{OUT} ≤ 1.75 V, V _{IN} = V _{OUT(E)} + 2.0 V		50		mA	①
CE "H" Level Voltage		V _{CEH}		1.6		V _{IN}	V	①
CE "L" Level Voltage		V _{CEL}				0.25	V	①
CE "H" Level Current		I _{CEH}	V _{CE} = V _{IN} = V _{OUT(E)} + 1.0 V When V _{OUT} ≤ 0.95 V, V _{CE} = V _{IN} = 2.0 V	-0.1		0.1	μA	②
CE "L" Level Current	Type G	I _{CEL}	V _{CE} = 0 V, V _{IN} = V _{OUT(E)} + 1.0 V When V _{OUT} ≤ 0.95 V, V _{CE} = V _{IN} = 2.0 V	-5.0		-0.8	μA	②
	Type H			-0.1		0.1		

NOTE:

- 1) Unless otherwise stated, V_{IN} = V_{OUT(T)} + 1.0 V. If V_{OUT} is less than 0.95 V, V_{IN} = 2.0 V; V_{OUT(T)} is Nominal output voltage and V_{OUT(E)} is Effective output voltage, (i.e. the output voltage when "V_{OUT(T)} + 1.0V" is provided at the V_{IN} pin, while maintaining a certain I_{OUT} value).
- 2) V_{DIF} = {V_{IN} - V_{OUT}}, where V_{IN1} is the input voltage when V_{OUT} = 0.98 V_{OUT(T)} appears, while input voltage gradually decreases
- 3) If V_{OUT(T)} is less than 1.45 V, MIN. = V_{OUT(T)} - 30 mV, MAX. = V_{OUT(T)} + 30 mV
- 4) For products with V_{OUT(T)} > 3.0 V only.
- 5) Refer to the "Dropout Voltage" table

ELECTRICAL OPERATING CHARACTERISTICS (CONTINUED)

Dropout Voltage for products with $\pm 2\%$ accuracy

SYMBOL	E-0		E-1		E-2	
	OUTPUT VOLTAGE, V ($\pm 2\%$)		DROPOUT VOLTAGE1, mV $I_{OUT} = 30\text{ mA}$		DROPOUT VOLTAGE 2, mV $I_{OUT} = 100\text{ mA}$	
	V_{OUT}		V_{DIF1}		V_{DIF2}	
$V_{OUT(T)}$	MIN.	MAX.	TYP.	MAX.	TYP.	MAX.
0.90	0.870	0.930	1100	1110	1150	1200
0.95	0.920	0.980				
1.00	0.970	1.030	1000	1010	1050	1100
1.05*	1.020	1.080				
1.10*	1.070	1.130	900	910	950	1000
1.15*	1.120	1.180				
1.20*	1.170	1.230	800	810	850	900
1.25*	1.220	1.280				
1.30*	1.270	1.330	700	710	750	800
1.35*	1.320	1.380				
1.40*	1.370	1.430	600	610	650	700
1.45*	1.420	1.480				
1.50*	1.470	1.530	500	510	550	600
1.55*	1.519	1.581				
1.60*	1.568	1.632	400	410	500	550
1.65*	1.617	1.683				
1.70*	1.666	1.734	300	310	400	450
1.75*	1.715	1.785				
1.80*	1.764	1.836	200	210	300	400
1.85*	1.813	1.887				
1.90*	1.862	1.938	120	150	280	380
1.95*	1.911	1.989				
2.00	1.960	2.040	80	120	240	350
2.05	2.009	2.091				330
2.10	2.058	2.142				
2.15	2.107	2.193				
2.20	2.156	2.244				
2.25	2.205	2.295				
2.30	2.254	2.346				
2.35	2.303	2.397				
2.40	2.352	2.448				
2.45	2.401	2.499				
2.50	2.450	2.550	70	100	220	
2.55	2.499	2.601				
2.60	2.548	2.652				
2.65	2.597	2.703				
2.70	2.646	2.754				
2.75	2.695	2.805				
2.80	2.744	2.856				
2.85	2.793	2.907				
2.90	2.842	2.958				
2.95	2.891	3.009				
3.00	2.940	3.060	60	90	200	270
3.05	2.989	3.111				
3.10	3.038	3.162				
3.15	3.087	3.213				
3.20	3.136	3.264				
3.25	3.185	3.315				
3.30	3.234	3.366				
3.35	3.283	3.417				
3.40	3.332	3.468				
3.45	3.381	3.519				
3.50	3.430	3.570				
3.55	3.479	3.621				

* Required operating voltage is $V_{IN} \geq 2.0\text{ V}$ minimum. $V_{DIF} = 2.0\text{ V} - V_{OUT(T)}$ minimum

ELECTRICAL OPERATING CHARACTERISTICS (CONTINUED)

Dropout Voltage for products with $\pm 2\%$ accuracy

SYMBOL	E-0		E-1		E-2	
	OUTPUT VOLTAGE, V ($\pm 2\%$)		DROPOUT VOLTAGE1, mV $I_{OUT} = 30\text{ mA}$		DROPOUT VOLTAGE 2, mV $I_{OUT} = 100\text{ mA}$	
	V_{OUT}		V_{DIF1}		V_{DIF2}	
$V_{OUT}(T)$	MIN.	MAX.	TYP.	MAX.	TYP.	MAX.
3.60	3.528	3.672	60	90	200	250
3.65	3.577	3.723				
3.70	3.626	3.774				
3.75	3.675	3.825				
3.80	3.724	3.876				
3.85	3.773	3.927				
3.90	3.822	3.978				
3.95	3.871	4.029				
4.00	3.920	4.080				
4.05	3.969	4.131				
4.10	4.018	4.182	60	80	180	230
4.15	4.067	4.233				
4.20	4.116	4.284				
4.25	4.165	4.335				
4.30	4.214	4.386				
4.35	4.263	4.437				
4.40	4.312	4.488				
4.45	4.361	4.539				
4.50	4.410	4.590				
4.55	4.459	4.641				
4.60	4.508	4.692	50	70	160	210
4.65	4.557	4.743				
4.70	4.606	4.794				
4.75	4.655	4.845				
4.80	4.704	4.896				
4.85	4.753	4.947				
4.90	4.802	4.998				
4.95	4.851	5.049				
5.00	4.900	5.100				
5.05	4.949	5.151				
5.10	4.998	5.202				
5.15	5.047	5.253				
5.20	5.096	5.304				
5.25	5.145	5.355				
5.30	5.194	5.406				
5.35	5.243	5.457				
5.40	5.292	5.508				
5.45	5.341	5.559				
5.50	5.390	5.610				
5.55	5.439	5.661				
5.60	5.488	5.712				
5.65	5.537	5.763				
5.70	5.586	5.814				
5.75	5.635	5.865				
5.80	5.684	5.916				
5.85	5.733	5.967				
5.90	5.782	6.018				
5.95	5.831	6.069				
6.00	5.880	6.120				

ELECTRICAL OPERATING CHARACTERISTICS (CONTINUED)

Output Voltage for products with $\pm 1\%$ accuracy

SYMBOL	E-0	
	OUTPUT VOLTAGE, V (1%)	
	VOUT	
V _{OUT(T)}	MIN.	MAX.
3.00	2.970	3.030
3.05	3.020	3.081
3.10	3.069	3.131
3.15	3.119	3.182
3.20	3.168	3.232
3.25	3.218	3.283
3.30	3.267	3.333
3.35	3.317	3.384
3.40	3.366	3.434
3.45	3.416	3.485
3.50	3.465	3.535
3.55	3.515	3.586
3.60	3.564	3.636
3.65	3.614	3.687
3.70	3.663	3.737
3.75	3.713	3.788
3.80	3.762	3.838
3.85	3.812	3.889
3.90	3.861	3.939
3.95	3.911	3.990
4.00	3.960	4.040
4.05	4.010	4.091
4.10	4.059	4.141
4.15	4.109	4.192
4.20	4.158	4.242
4.25	4.208	4.293
4.30	4.257	4.343
4.35	4.307	4.394
4.40	4.356	4.444
4.45	4.405	4.494
4.50	4.455	4.545

SYMBOL	E-0	
	OUTPUT VOLTAGE, V (1%)	
	VOUT	
V _{OUT(T)}	MIN.	MAX.
4.55	4.505	4.596
4.60	4.554	4.646
4.65	4.604	4.697
4.70	4.653	4.747
4.75	4.703	4.798
4.80	4.752	4.848
4.85	4.802	4.899
4.90	4.851	4.949
4.95	4.901	5.000
5.00	4.950	5.050
5.05	4.000	5.101
5.10	4.049	5.151
5.15	4.099	5.202
5.20	4.148	5.252
5.25	5.198	5.303
5.30	5.247	5.353
5.35	5.297	5.404
5.40	5.346	5.454
5.45	5.396	5.505
5.50	5.445	5.555
5.55	5.495	5.606
5.60	5.544	5.656
5.65	5.594	5.707
5.70	5.643	5.757
5.75	5.693	5.808
5.80	5.742	5.858
5.85	5.792	5.909
5.90	5.841	5.959
5.95	5.891	6.010
6.00	5.940	6.060

Conditions

SYMBOL	E-3	E-4
NOMINAL OUTPUT VOLTAGE, V	INPUT VOLTAGE, V	MAXIMUM OUTPUT CURRENT, (mA)
V _{OUT(T)}	V _{IN}	MIN VALUE
0.90 ~ 0.95	2.5	260
1.00 ~ 1.05	2.5	260
1.10 ~ 1.15	2.6	270
1.20 ~ 1.25	2.7	290
1.30 ~ 1.35	2.8	300
1.40 ~ 1.45	2.9	
1.50 ~ 1.95	3.0	
2.00 ~ 6.00	V _{OUT(T)} + 1.0	

PIN CONFIGURATION

IXD1209

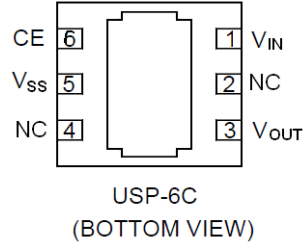
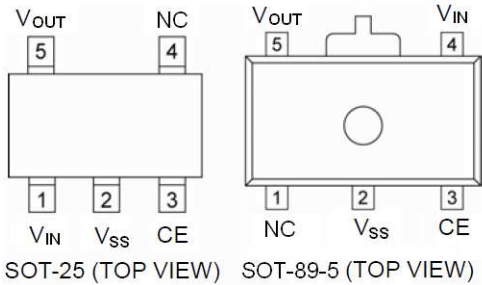

*The dissipation pad for the USP-6B package should be solder-plated in recommended mounting pattern and metal masking to enhance mounting strength and heat release. If the pad needs to be connected to other pins, it should be connected to the V_{SS} (No.5) pin.

IXD1212

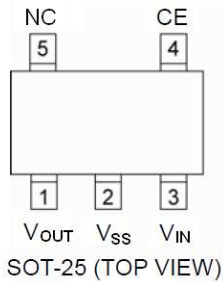

PIN ASSIGNMENT

PIN NUMBER				PIN NAME	FUNCTIONS
IXD1209		IXD1212			
SOT-25	SOT-89 5	USP-6B	SOT-25		
1	4	1	3	V _{IN}	Power Input
2	2	5	2	V _{SS}	Ground
3	3	6	4	CE	ON/OFF Control
4	1	2, 4	5	NC	No Connection
5	5	3	1	V _{OUT}	Output Voltage

CE PIN FUNCTION

IC TYPE	CE PIN STATE	IC STATE
A, B, E, F	H	ON
	L	OFF
C, D, G, H	H	OFF
	L	ON

BLOCK DIAGRAMS

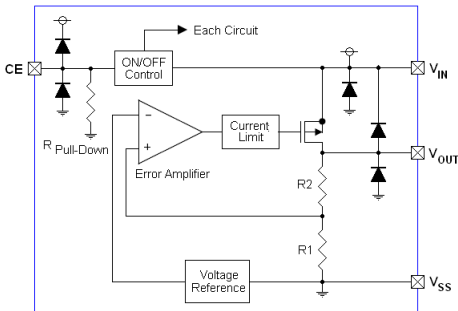

IXD2109/12 Type A, E

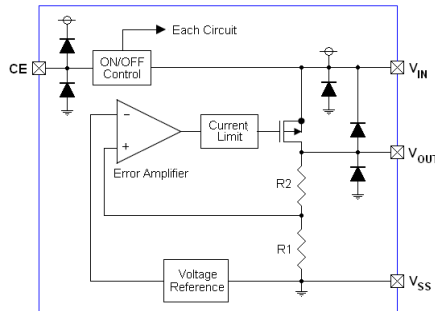

IXD2109/12 Type B, D, F, H

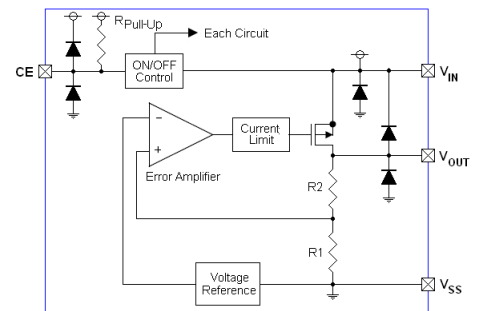

IXD2109/12 Type C, G

Diodes inside the circuits are ESD protection diodes and parasitic diodes.

BASIC OPERATION

The Error Amplifier of the IXD1209/12 series monitors output voltage divided by internal resistors R1 & R2 and compares it with the internal Reference Voltage (see Block Diagram above). The output signal from error amplifier drives gate of the P-channel MOSFET, which is connected to the V_{OUT} pin and operates as a series voltage regulator.

The Current Limit and Short Protection circuits monitor level of the output current. The CE pin allows shutdown internal circuitry to minimize power consumption.

Low ESR Capacitors

An internal phase compensation circuit guarantees stable IXD1209/12 operation even if output capacitors with low ESR are used. However, connect the output capacitor C_L as close to the V_{OUT} and the V_{SS} pins as possible to prevent effectiveness of the phase compensation from degrade. The C_L capacitance value should be at least $1\mu\text{F}$. In case the capacitor depends on the bias and temperature, make sure that actual capacitance is maintained at operating voltage and temperature range. In addition, an input capacitor $C_{IN} \geq 0.1\mu\text{F}$ between the V_{IN} and V_{SS} pins should be used to ensure a stable input power.

Current Limiter, Short-Circuit Protection

The IXD1209/12 series include a combination of a fixed current limiter circuit & a foldback circuit, which aid the operations of the current limiter and circuit protection. When the load current reaches the current limit level, the fixed current limiter circuit activates and output voltage drops. Because of this drop, the foldback circuit activates too, and output voltage drops further decreasing output current. When the output pin is shorted, a current of about 50 mA flows.

CE Pin

The CE pin allows shutdown internal circuitry to minimize power consumption. In shutdown mode, output at the V_{OUT} pin is pulled down to the V_{SS} level via R1 & R2. The operational logic of the CE pin is selectable (please, refer to the CE PIN FUNCTION Table above).

Note that the standard IXD1209/12B type CE input is an Active High/No Pull Down and operations will become unstable, if the CE pin is open. CE pin should be used with either V_{IN} or V_{SS} voltage. If this IC is used with some intermediate voltage at CE pin, supply current may increase due through current in the IC's internal circuitry.

TYPICAL APPLICATION CIRCUIT

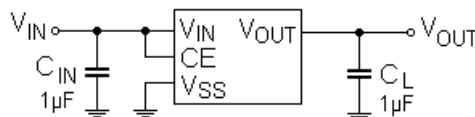

The output capacitor $C_L \geq 1\mu\text{F}$ should be connected between the output pin (V_{OUT}) and the V_{SS} pin for stable regulator's operation. Ceramic capacitors with low ESR are recommended.

LAYOUT AND USE CONSIDERATIONS

1. Mount external component as close to the IC as possible and use thick, short connecting traces to reduce the circuit impedance.
2. The IC may malfunction if absolute maximum ratings are exceeded.
3. If power source of this regulator is a high impedance device with impedance of 10Ω or more, an input capacitor $C_{IN} \geq 1\mu\text{F}$ should be used to prevent oscillations.
4. In case of high output current, increasing the input capacitor value can stabilize operations.
5. Oscillations may occur also, if the input capacitor value is not enough to reduce the input impedance and the output capacitor C_L is large. In such case, operations can be stabilized by either increasing the input capacitor or reducing the output capacitor.
6. During start-up, IC provides constant current until $V_{OUT} = V_{OUT(T)}$.
7. Please ensure that output current I_{OUT} is less than $P_D / (V_{IN} - V_{OUT})$, where P_D is a rated power dissipation value of the package shown at ABSOLUTE MAXIMUM RATING table to not exceed it.

TEST CIRCUITS

Circuit ①

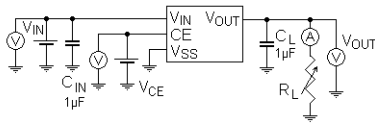

Circuit ②

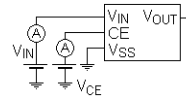

Circuit ③

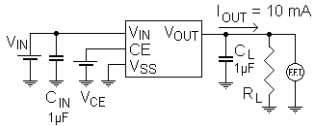

Circuit ④

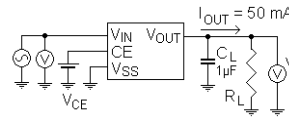

$$V_{IN} = V_{OUT} + 1.0 V_{DC} + 1.0 V_{p-pAC}, \text{ if } V_{OUT} \leq 1.5 V, V_{IN} = 2.5 V_{DC} + 1.0 V_{p-pAC}$$

* Each Test Circuit, V_{CE} (CE pin Voltage)

IC Active State

IXD1209/12, Type A, B, E, F: $V_{CE} = V_{IN}$

IXD1209/12, Type C, D, G, H: $V_{CE} = V_{SS}$

IC in Standby mode

IXD1209/12, Type A, B, E, F: $V_{CE} = V_{SS}$

IXD1209/12, Type C, D, G, H: $V_{CE} = V_{IN}$

TYPICAL PERFORMANCE CHARACTERISTICS

(1) Ripple rejection Ratio

IXD1209/12 BF302

$V_{IN} = 4 V_{DC} + 1 V_{p-pAC}$, $I_{OUT} = 30 \text{ mA}$, $C_L = 1 \mu\text{F}$ (ceramic)

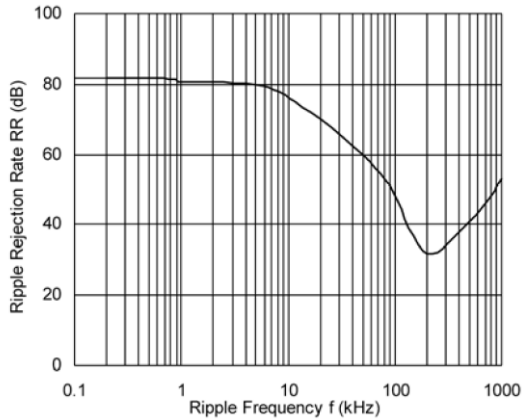

IXD1209/12 B/F122

$V_{IN} = 2.5 V_{DC} + 1 V_{p-pAC}$, $I_{OUT} = 30 \text{ mA}$, $C_L = 1 \mu\text{F}$ (ceramic)

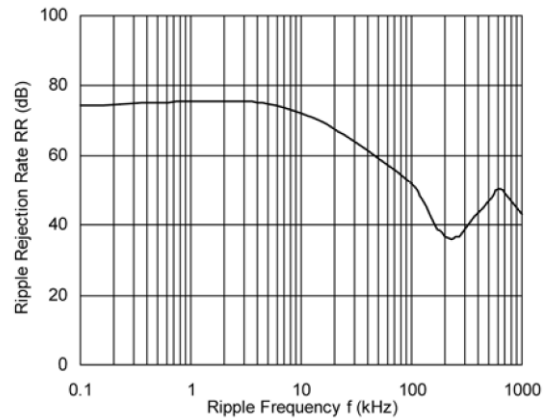

TYPICAL PERFORMANCE CHARACTERISTICS (Continued)

(2) Output Voltage vs Output Current

Topr = 25 °C

IXD1209/12 B302

C_{IN} = C_L = 1μF, (ceramic), V_{IN} = 4.0 V

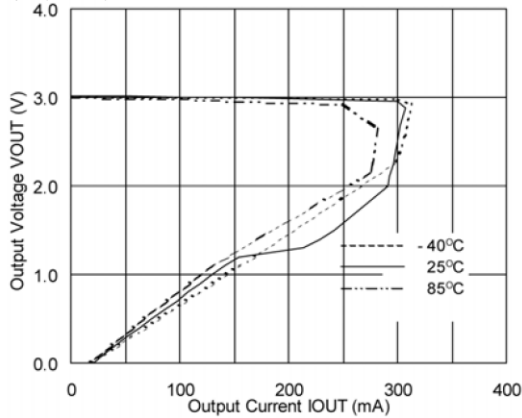

IXD1209/12 B302

C_{IN} = C_L = 1μF, (ceramic), Ta = 25°C

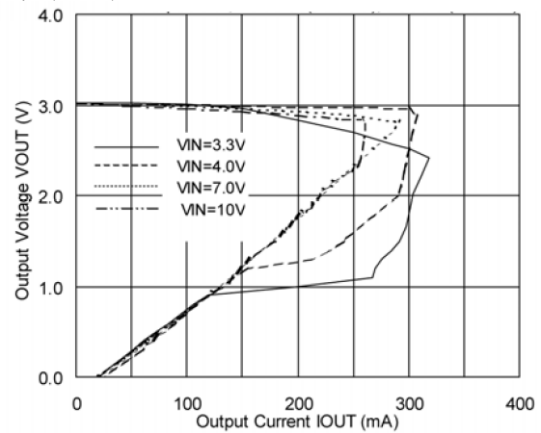

IXD1209/12 F302

C_{IN} = C_L = 1μF, (ceramic), V_{IN} = 4.0 V

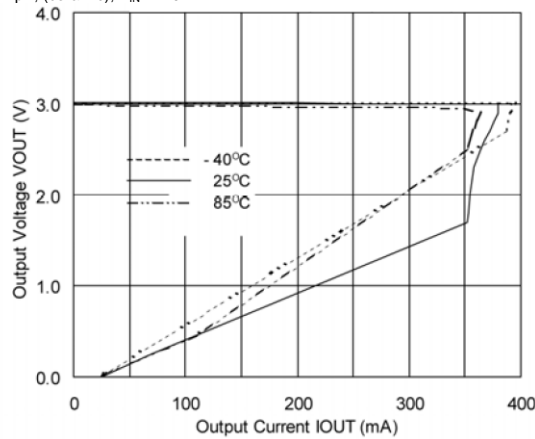

IXD1209/12 F302

C_{IN} = C_L = 1μF, (ceramic), Ta = 25°C

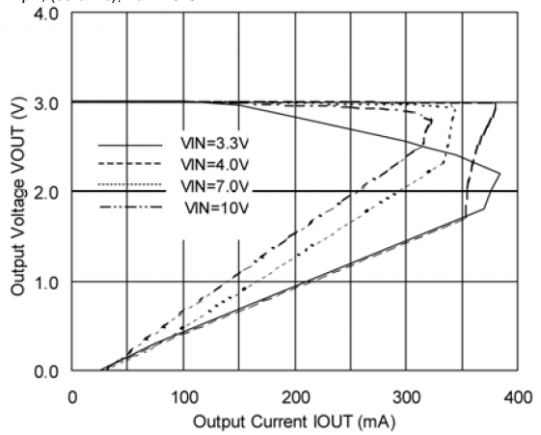

IXD1209/12 B122

C_{IN} = C_L = 1μF, (ceramic), V_{IN} = 2.7 V

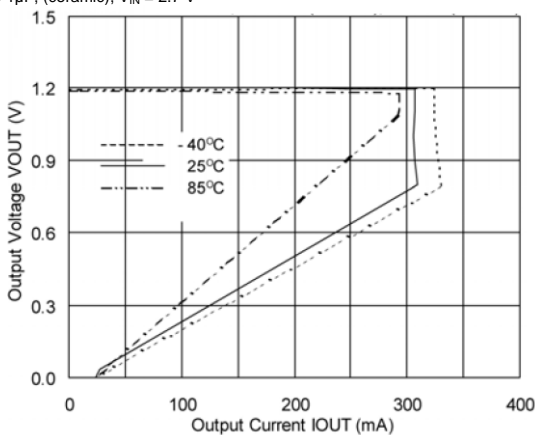

IXD1209/12 B122

C_{IN} = C_L = 1μF, (ceramic), Ta = 25°C

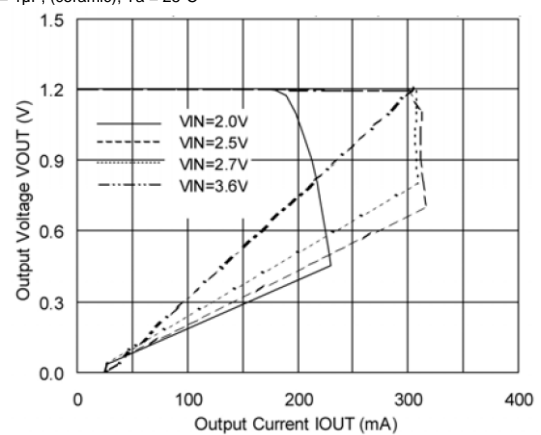

TYPICAL PERFORMANCE CHARACTERISTICS (Continued)

(2) Output Voltage vs. Output Current (Continue)

$T_{opr} = 25^{\circ}\text{C}$

IXD1209/12 F122

$C_{IN} = C_L = 1\mu\text{F}$, (ceramic), $V_{IN} = 2.7\text{V}$

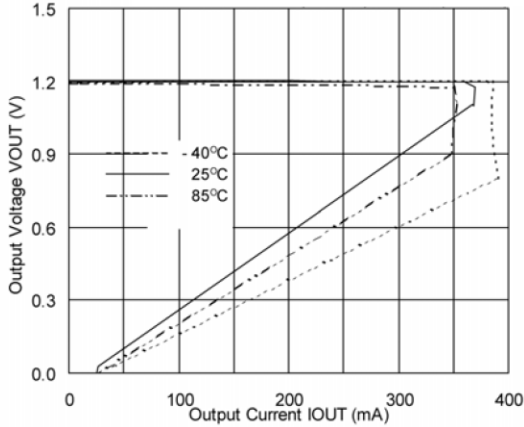

IXD1209/12 F122

$C_{IN} = C_L = 1\mu\text{F}$, (ceramic), $T_a = 25^{\circ}\text{C}$

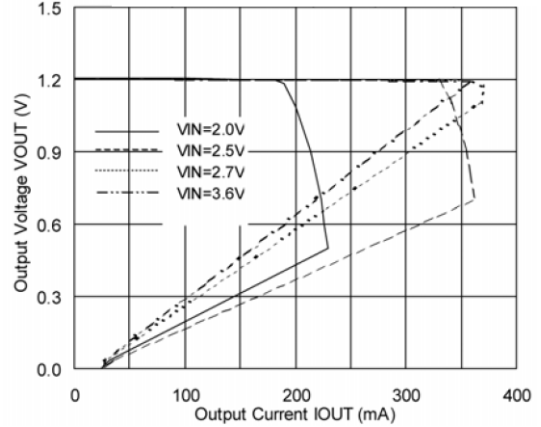

(3) Output Voltage vs. Input Voltage

IXD1209/12 F302

$C_{IN} = C_L = 1\mu\text{F}$, (ceramic), $T_a = 25^{\circ}\text{C}$

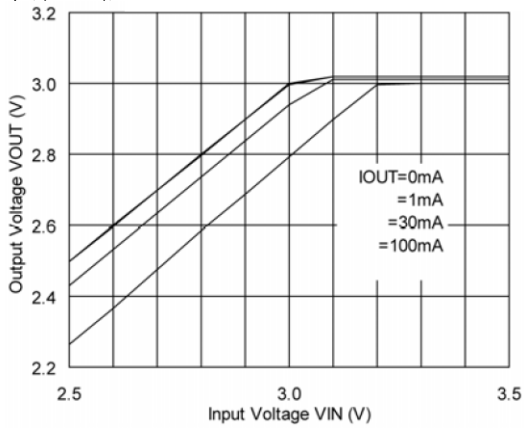

IXD1209/12 F302

$C_{IN} = C_L = 1\mu\text{F}$, (ceramic), $T_a = 25^{\circ}\text{C}$

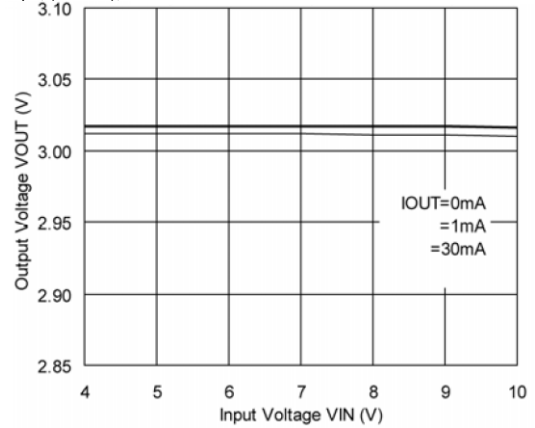

IXD1209/12 F302

$C_{IN} = C_L = 1\mu\text{F}$, (ceramic), $T_a = 25^{\circ}\text{C}$

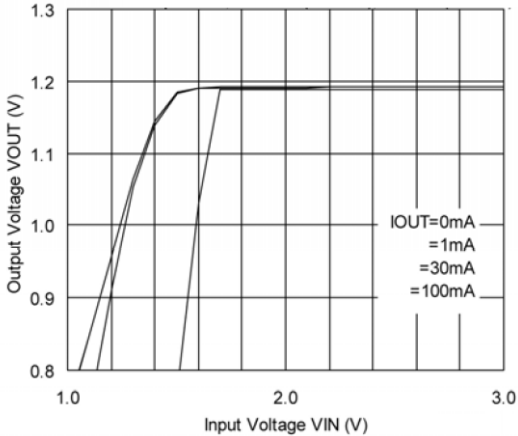

IXD1209/12 F302

$C_{IN} = C_L = 1\mu\text{F}$, (ceramic), $T_a = 25^{\circ}\text{C}$

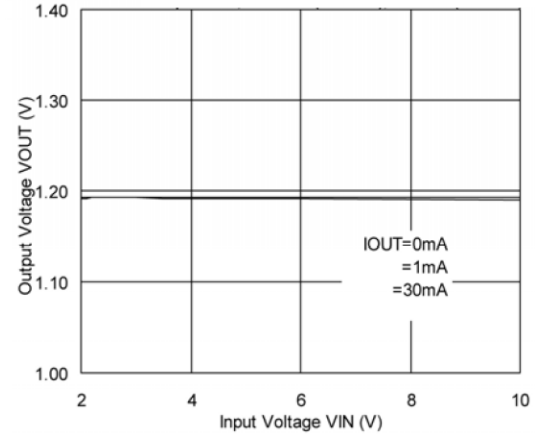

TYPICAL PERFORMANCE CHARACTERISTICS (Continued)

(4) Dropout Voltage vs. Output Current

$T_{opr} = 25^\circ\text{C}$

IXD1209/12 B302

$C_{IN} = C_L = 1\mu\text{F}$, (ceramic)

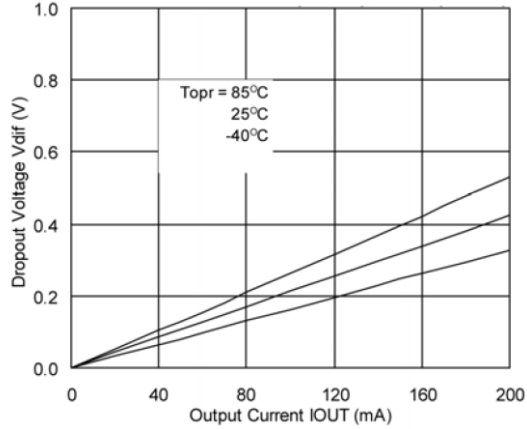

IXD1209/12 F302

$C_{IN} = C_L = 1\mu\text{F}$, (ceramic)

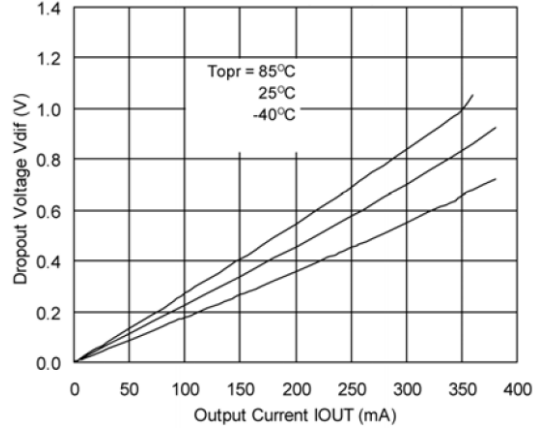

IXD1209/12 B122

$C_{IN} = C_L = 1\mu\text{F}$, (ceramic)

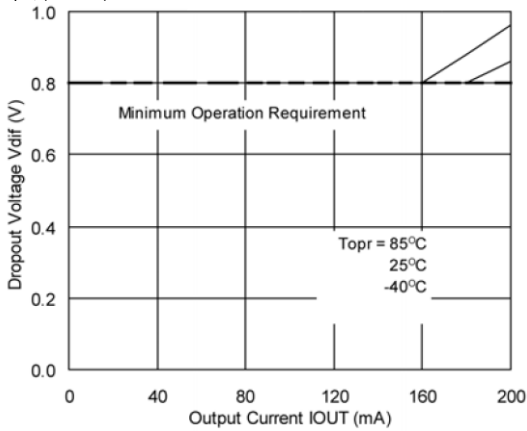

IXD1209/12 F122

$C_{IN} = C_L = 1\mu\text{F}$, (ceramic)

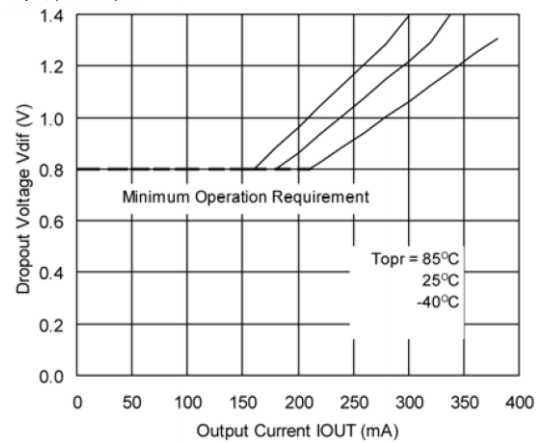

(5) Supply Current vs. Input Voltage

IXD1209/12 F302

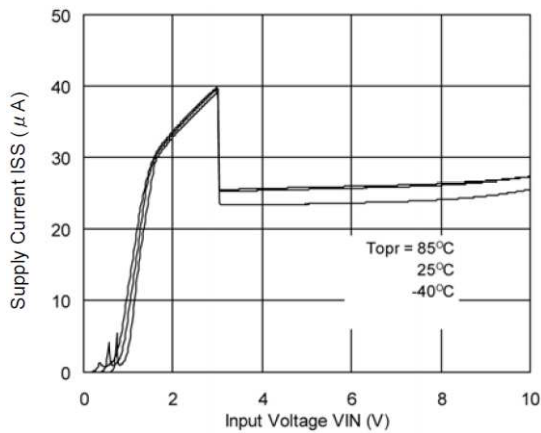

IXD1209/12 F122

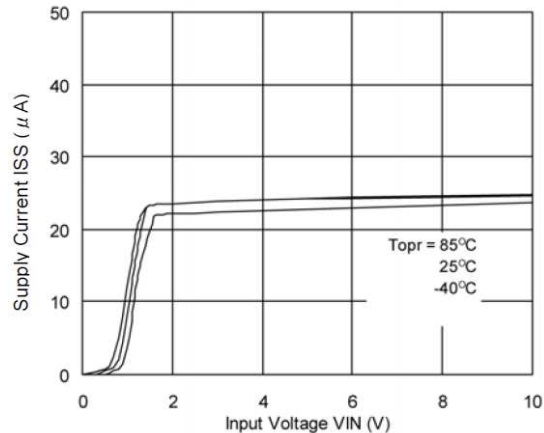

TYPICAL PERFORMANCE CHARACTERISTICS (Continued)

(6) Output Voltage vs. Ambient temperature

IXD1209/12 B/F302

$C_{IN} = C_L = 1\mu\text{F}$, (ceramic), $V_{IN} = 4.0\text{ V}$

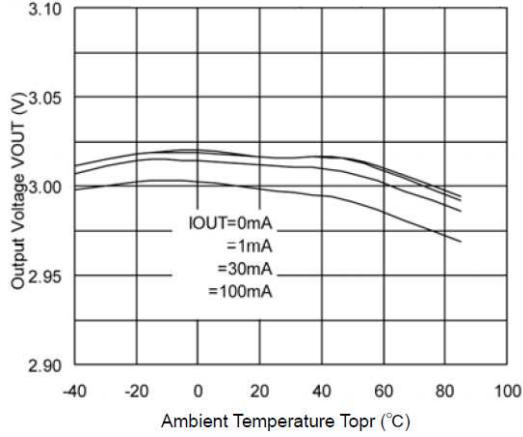

IXD1209/12 B122

$C_{IN} = C_L = 1\mu\text{F}$, (ceramic), $V_{IN} = 2.5\text{ V}$

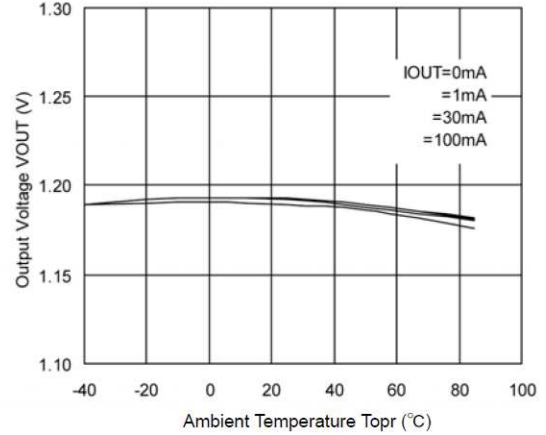

(7) Supply Current vs. Ambient temperature

IXD1209/12 B/F302

$V_{IN} = 4.0\text{ V}$

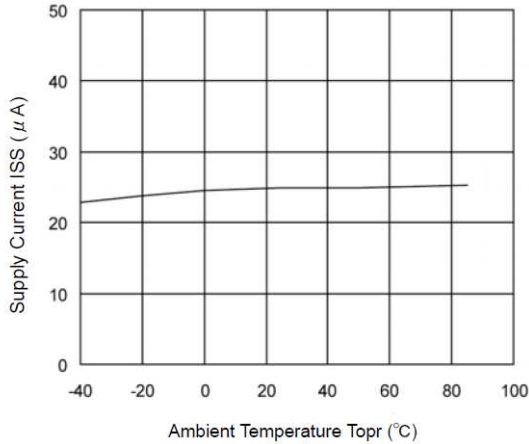

IXD1209/12 B122

$V_{IN} = 2.5\text{ V}$

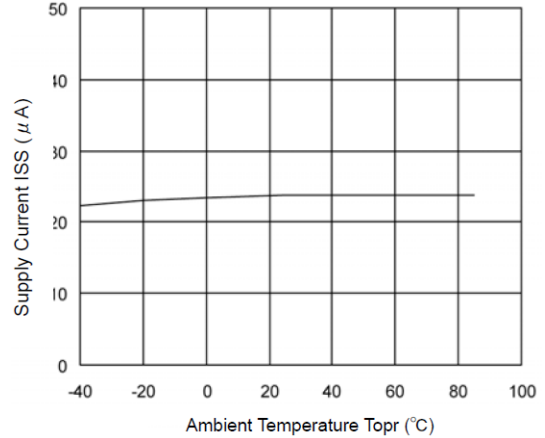

IXD1209

(8) P-channel Transistor Characteristics

IXD1209/12 B/F

$T_a = 25^\circ\text{C}$

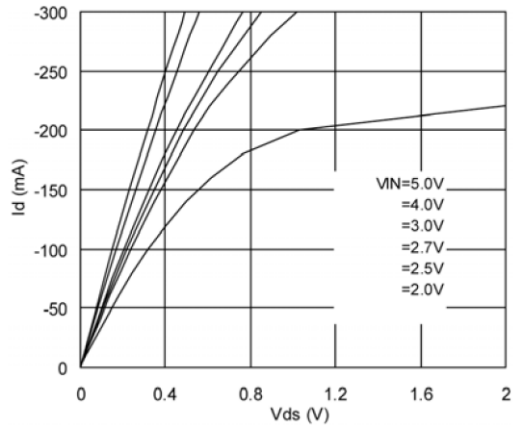

TYPICAL PERFORMANCE CHARACTERISTICS (Continued)

(9) Input Voltage Transient Response

IXD1209/12 B/F302

$C_{IN} = C_L = 1\mu\text{F}$, (ceramic), $I_{OUT} = 1\text{ mA}$, $t_R = 5\text{ us}$

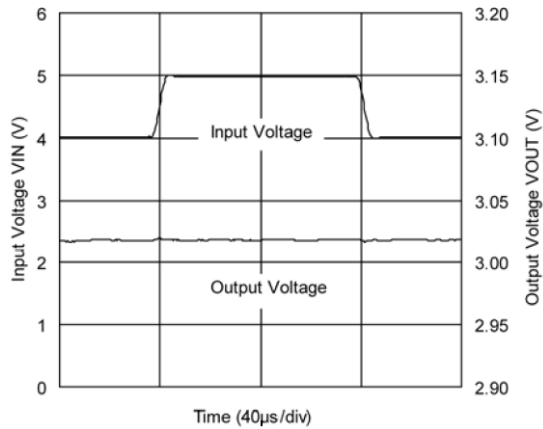

IXD1209/12 B/F302

$C_{IN} = C_L = 1\mu\text{F}$, (ceramic), $I_{OUT} = 30\text{ mA}$, $t_R = 5\text{ us}$

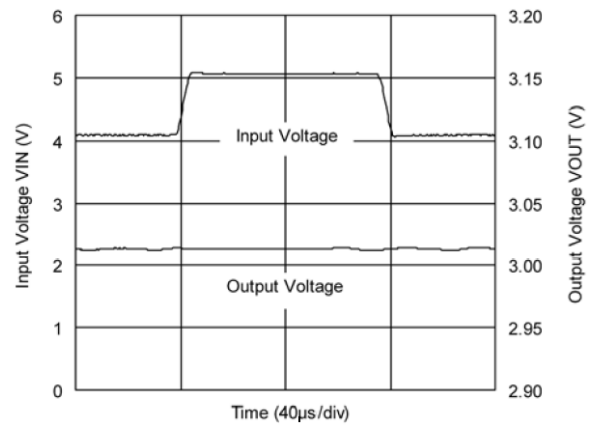

IXD1209/12 B/F302

$C_{IN} = C_L = 1\mu\text{F}$, (ceramic), $I_{OUT} = 100\text{ mA}$, $t_R = 5\text{ us}$

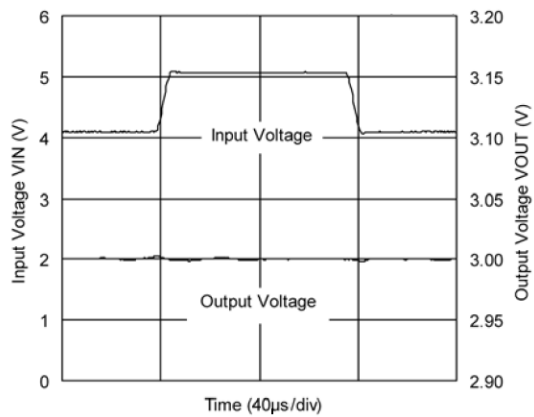

IXD1209/12 B122

$C_{IN} = C_L = 1\mu\text{F}$, (ceramic), $I_{OUT} = 1\text{ mA}$, $t_R = 5\text{ us}$

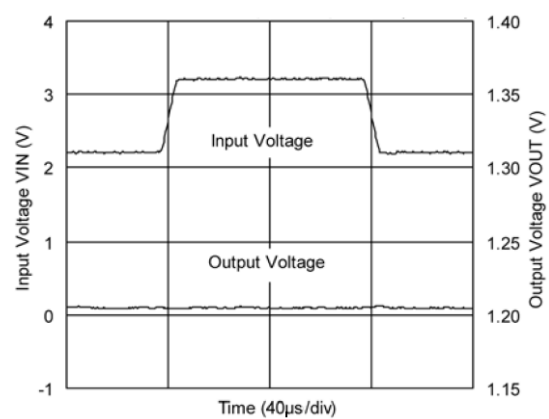

IXD1209/12 B122

$C_{IN} = C_L = 1\mu\text{F}$, (ceramic), $I_{OUT} = 30\text{ mA}$, $t_R = 5\text{ us}$

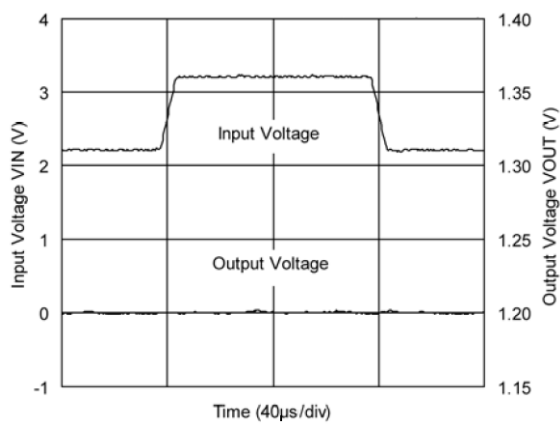

IXD1209/12 B122

$C_{IN} = C_L = 1\mu\text{F}$, (ceramic), $I_{OUT} = 100\text{ mA}$, $t_R = 5\text{ us}$

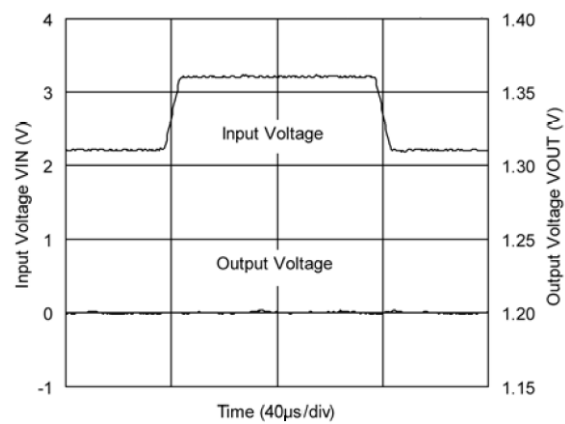

TYPICAL PERFORMANCE CHARACTERISTICS (Continued)

(10) Load Transient Response

IXD1209/12 B/F302

$C_{IN} = C_L = 1\mu\text{F}$, (ceramic), $V_{IN} = 4.0\text{ V}$, $t_r = t_f = 5\text{ us}$

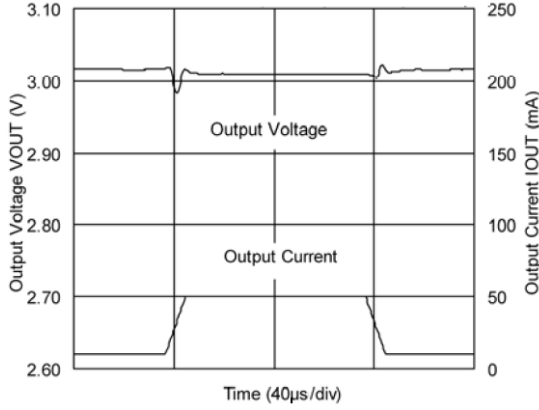

IXD1209/12 B/F302

$C_{IN} = 1\mu\text{F}$, (ceramic), $C_L = 2.2\mu\text{F}$, (ceramic), $V_{IN} = 4.0\text{ V}$, $t_r = t_f = 5\text{ us}$

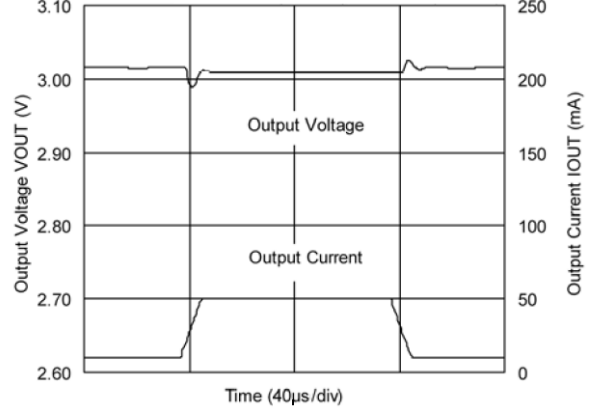

IXD1209/12 B/F302

$C_{IN} = C_L = 1\mu\text{F}$, (ceramic), $V_{IN} = 4.0\text{ V}$, $t_r = t_f = 5\text{ us}$

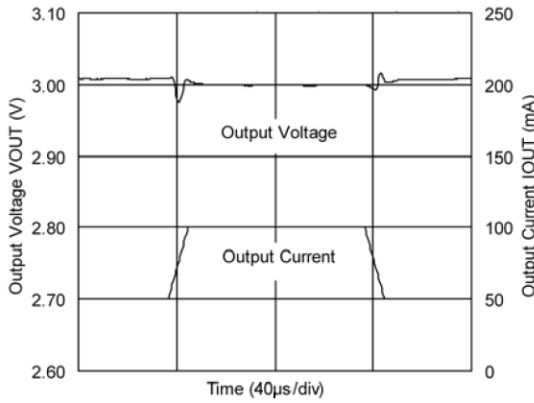

IXD1209/12 B/F302

$C_{IN} = 1\mu\text{F}$, (ceramic), $C_L = 2.2\mu\text{F}$, (ceramic), $V_{IN} = 4.0\text{ V}$, $t_r = t_f = 5\text{ us}$

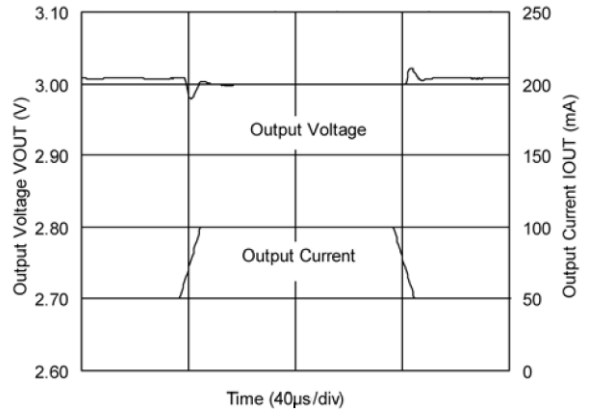

IXD1209/12 B/F302

$C_{IN} = C_L = 1\mu\text{F}$, (ceramic), $V_{IN} = 4.0\text{ V}$, $t_r = t_f = 5\text{ us}$

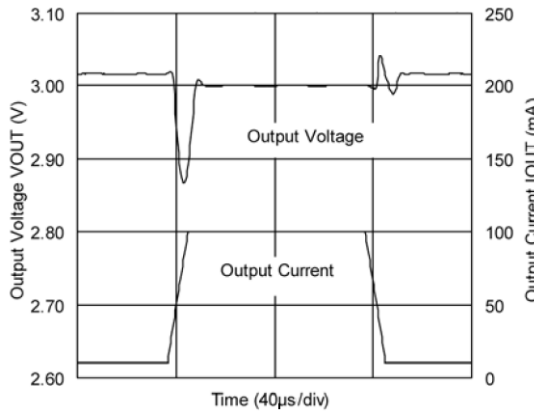

IXD1209/12 B/F302

$C_{IN} = 1\mu\text{F}$, (ceramic), $C_L = 2.2\mu\text{F}$, (ceramic), $V_{IN} = 4.0\text{ V}$, $t_r = t_f = 5\text{ us}$

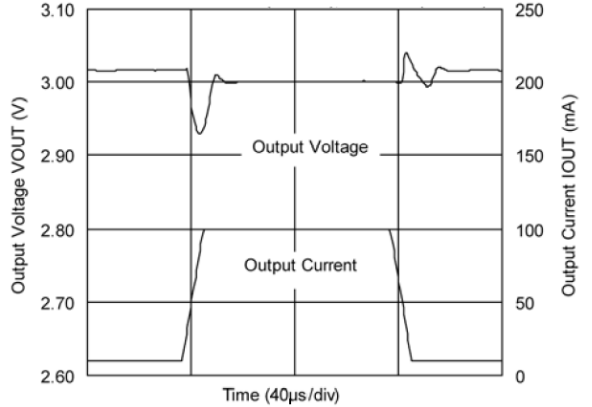

TYPICAL PERFORMANCE CHARACTERISTICS (Continued)

(10) Load Transient Response (Continued)

IXD1209/12 B/F122

$C_{IN} = C_L = 1\mu\text{F}$, (ceramic), $V_{IN} = 2.5\text{ V}$, $t_R = t_F = 5\text{ us}$

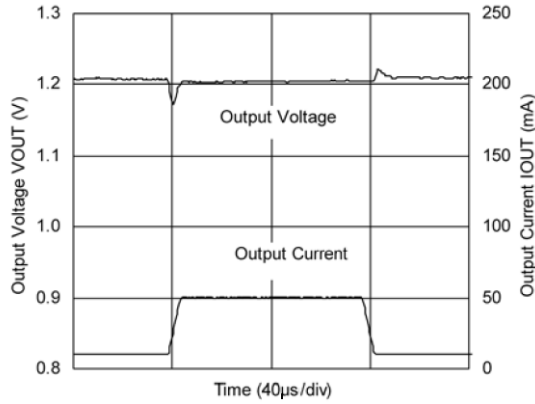

IXD1209/12 B/F122

$C_{IN} = 1\mu\text{F}$, (ceramic), $C_L = 2.2\mu\text{F}$, (ceramic), $V_{IN} = 2.5\text{ V}$, $t_R = t_F = 5\text{ us}$

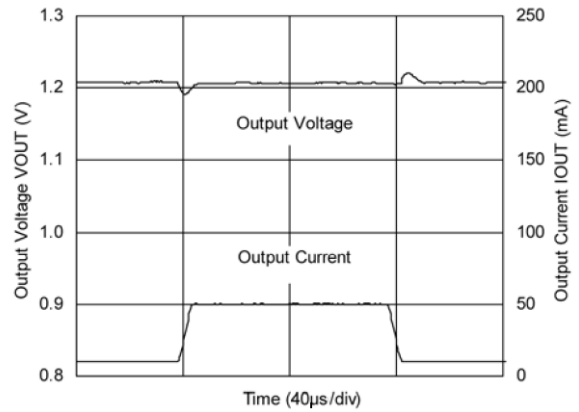

IXD1209/12 B/F122

$C_{IN} = C_L = 1\mu\text{F}$, (ceramic), $V_{IN} = 2.5\text{ V}$, $t_R = t_F = 5\text{ us}$

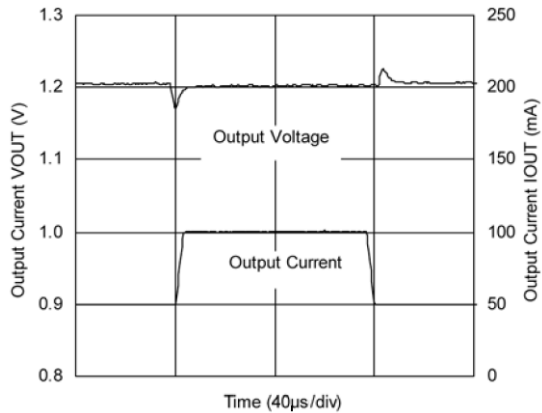

IXD1209/12 B/F122

$C_{IN} = 1\mu\text{F}$, (ceramic), $C_L = 2.2\mu\text{F}$, (ceramic), $V_{IN} = 2.5\text{ V}$, $t_R = t_F = 5\text{ us}$

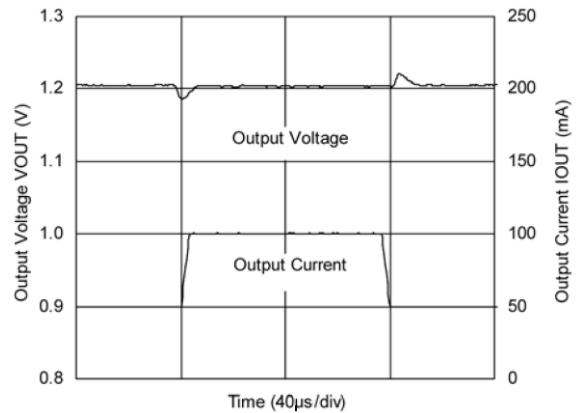

IXD1209/12 B/F122

$C_{IN} = C_L = 1\mu\text{F}$, (ceramic), $V_{IN} = 2.5\text{ V}$, $t_R = t_F = 5\text{ us}$

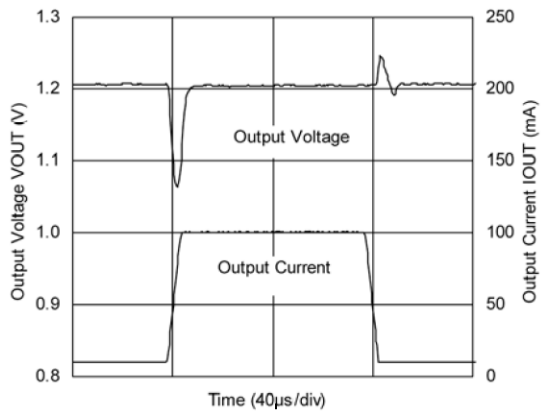

IXD1209/12 B/F122

$C_{IN} = 1\mu\text{F}$, (ceramic), $C_L = 2.2\mu\text{F}$, (ceramic), $V_{IN} = 2.5\text{ V}$, $t_R = t_F = 5\text{ us}$

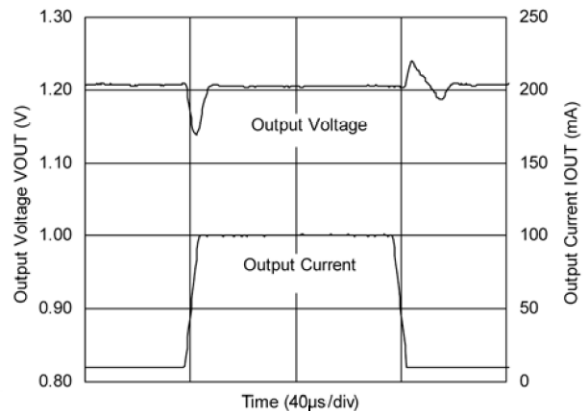

ORDERING INFORMATION

IXD1209①②③④⑤⑥-⑦

IXD1212①②③④⑤⑥-⑦

DESIGNATOR	DESCRIPTION	SYMBOL	DESCRIPTION
①	Type of Regulator CE PIN Logic	A	150 mA, Active High, Pull-down resistor built-in ⁽²⁾ (Semi-custom)
		B	150 mA, Active High, No pull-down resistor (Standard)
		C	150 mA, Active Low, Pull-up resistor built-in ⁽²⁾ (Semi-custom)
		D	150 mA, Active Low, No pull-up resistor (Semi-custom)
		E	300 mA ⁽¹⁾ , Active High, Pull-down resistor built-in ⁽²⁾ (Semi-custom)
		F	300 mA ⁽¹⁾ , Active High, No pull-down resistor (Standard)
		G	300 mA ⁽¹⁾ , Active Low, Pull-up resistor built-in ⁽²⁾ (Semi-custom)
		H	300 mA ⁽¹⁾ , Active Low, No pull-up resistor (Semi-custom)
②③	Output Voltage	09 - 60	Output Voltage Range: 0.9 V~6.0 V, e.g. 3.0 V - ② = 3, ③ = 0
		30 - 60	For 1% product, output voltage range is 3.0 V~6.0 V.
④	Output Voltage Accuracy	1	0.1 V increments, Accuracy: ±1%, e.g. 3.00 V - ② = 3, ③ = 0, ④ = 1
		2	0.1 V increments, Accuracy: ±2% ⁽³⁾ , e.g. 2.80V - ② = 2, ③ = 8, ④ = 2
		A	0.05 V increments, Accuracy: ±2% ⁽³⁾ , e.g.: 2.85 V - ② = 2, ③ = 8, ④ = A
		B	0.05 V increments, Accuracy: ±1%, e.g.: 3.05 V - ② = 3, ③ = 0, ④ = B
⑤⑥-⑦ ⁽⁴⁾	Packages (Order Limit)	MR	SOT-25 (3000/Reel)
		MR-G	SOT-25 (3000/Reel)
		PR	SOT-89 (3000/Reel)
		PR-G	SOT-89 (3000/Reel)
		DR	USP-6B (3000/Reel)
		DR-G	USP-6B (3000/Reel)

NOTE:

(*1) The maximum output current of type E ~ H depends on setting output voltage.

(*2) With the pull-up resistor or pull-down resistor built-in types, the supply current during operation will increase by $V_{IN} / 2 \text{ M}\Omega$ (TYP.).

(*3) The output voltage accuracy is ±30 mV at $V_{OUT} \leq 1.5 \text{ V}$.

(*4) The "-G" suffix denotes Halogen and Antimony free as well as being fully RoHS compliant.

PACKAGE DRAWING AND DIMENSIONS

SOT-25, Units: mm

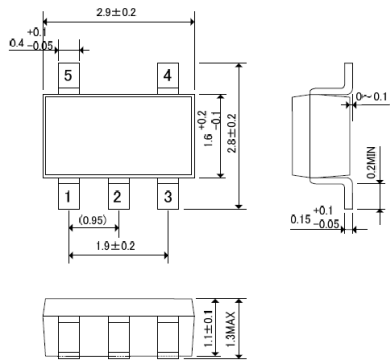

SOT-89-5, Units: mm

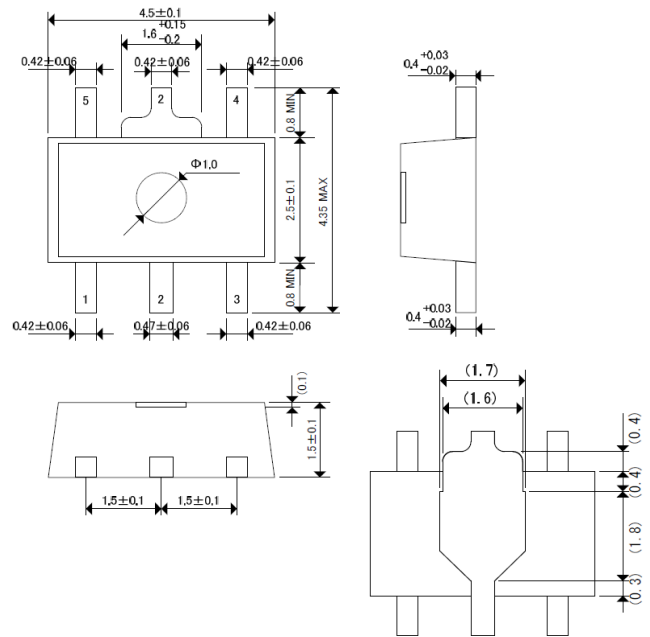

USP-6B, Units: mm

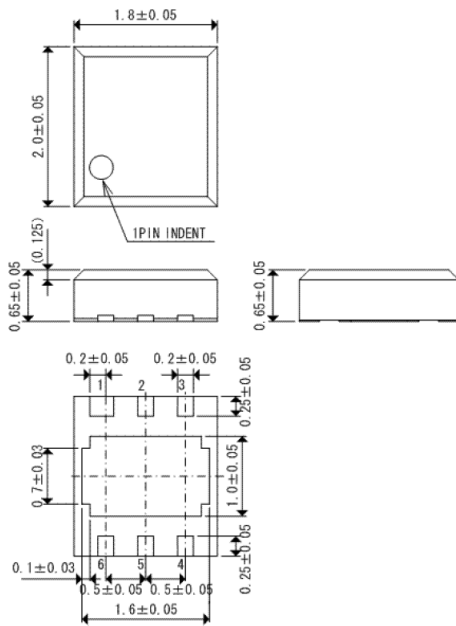

USP-6B Reference Pattern Layout, Units: mm

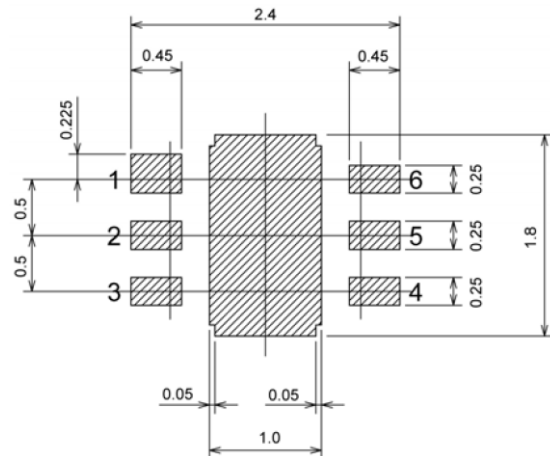

USP-6B Reference Metal Mask Design, Units: mm

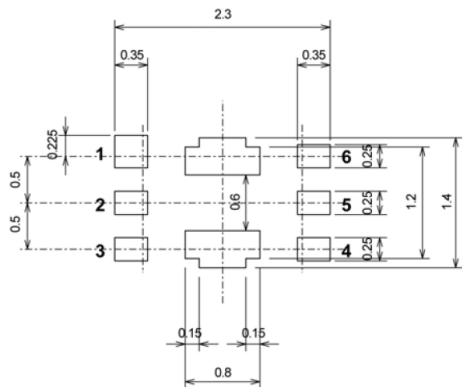

PACKAGE POWER DISSIPATION

SOT-25 Power Dissipation

The power dissipation varies with the mount board conditions. Please use this data as a reference only.

1. Measurement Conditions:

- Condition: Mount on a board
- Ambient: Natural convection
- Soldering: Lead (Pb) free
- Board: Dimensions 40x40 mm (1600 mm² in one side)
Copper (Cu) traces occupy 50% of the board area on top and bottom layers
Package heat sink tied to the copper traces.
(Board of SOT-26 is used)
- Material: Glass Epoxy (FR-4)
- Thickness: 1.6 mm
- Through-hole: 4 x 0.8 Diameter

2. Power Dissipation vs. Ambient Temperature

Board Mount (T_{jmax} = 125 °C)

Ambient Temperature, °C	Power Dissipation Pd, mW	Thermal Resistance, °C/W
25	600	166.67
85	240	

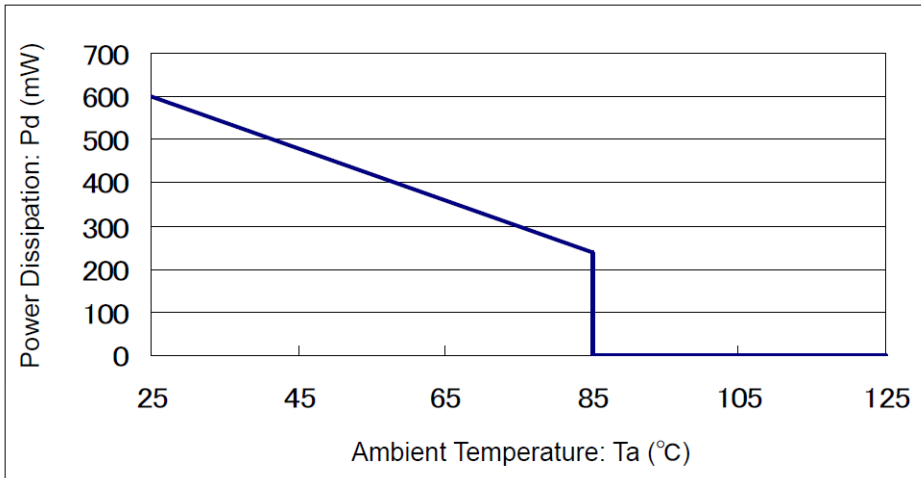
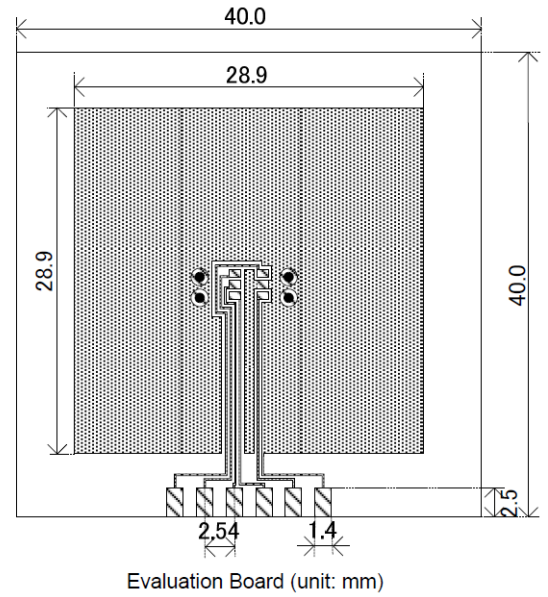

PACKAGE POWER DISSIPATION (CONTINUED)

SOT-89-5 Power Dissipation

The power dissipation varies with the mount board conditions. Please use this data as a reference only.

1. Measurement Conditions:

- Condition: Mount on a board
- Ambient: Natural convection
- Soldering: Lead (Pb) free
- Board: Dimensions 40x40 mm (1600 mm² in one side)
Copper (Cu) traces occupy 50% of the board area on top and bottom layers
Package heat sink tied to the copper traces.
(Board of SOT-26 is used)
- Material: Glass Epoxy (FR-4)
- Thickness: 1.6 mm
- Through-hole: 5 x 0.8 Diameter

2. Power Dissipation vs. Ambient Temperature

Board Mount (T_{jmax} = 125 °C)

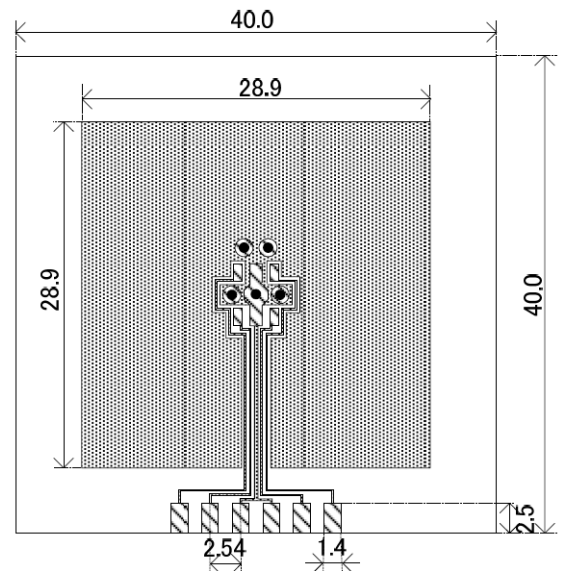

Evaluation Board (unit: mm)

Ambient Temperature, °C	Power Dissipation Pd, mW	Thermal Resistance, °C/W
25	1300	76.92
85	520	

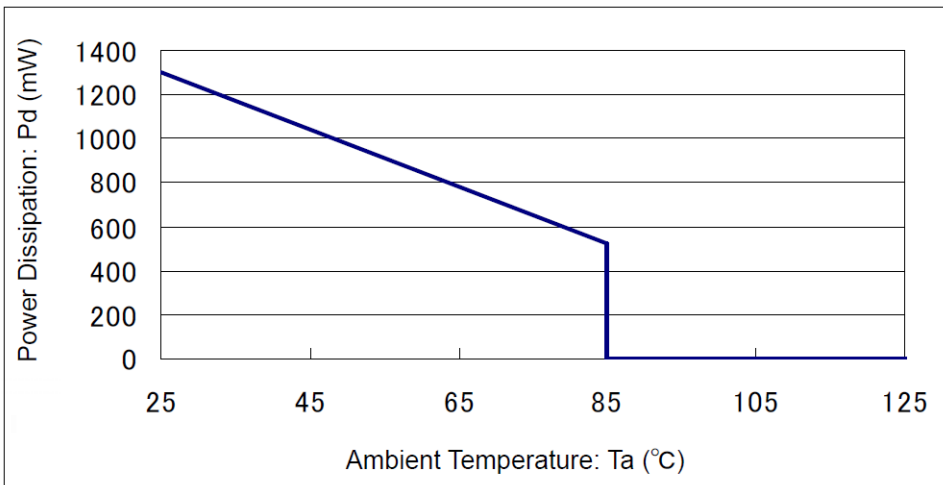

PACKAGE POWER DISSIPATION (CONTINUED)

USP-6B Power Dissipation

The power dissipation varies with the mount board conditions. Please use this data as a reference only.

1. Measurement Conditions:

- Condition: Mount on a board
- Ambient: Natural convection
- Soldering: Lead (Pb) free
- Board: Dimensions 40x40 mm (1600 mm² in one side)
Copper (Cu) traces occupy 50% of the board area on top and bottom layers
Package heat sink tied to the copper traces.
(Board of SOT-26 is used)
- Material: Glass Epoxy (FR-4)
- Thickness: 1.6 mm
- Through-hole: 4 x 0.8 Diameter

2. Power Dissipation vs. Ambient Temperature

Board Mount (T_{jmax} = 125 °C)

Ambient Temperature, °C	Power Dissipation Pd, mW	Thermal Resistance, °C/W
25	1000	100.00
85	400	

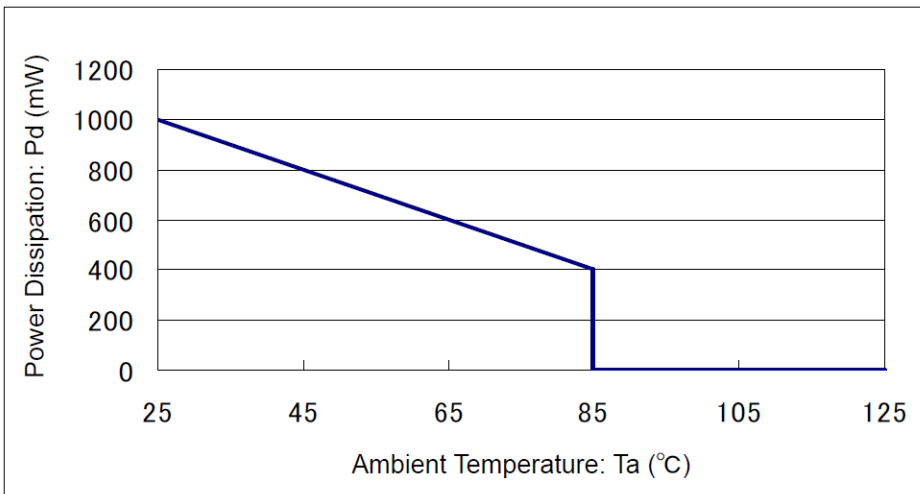
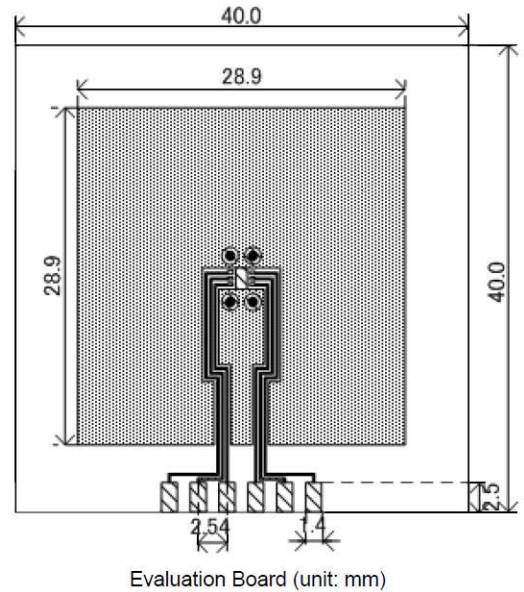

MARKING

IXD1209

SOT-25, SOT 89

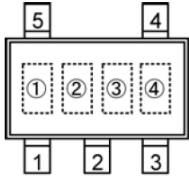

SOT-25 (TOP VIEW)

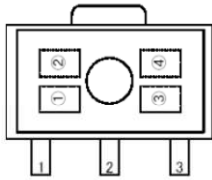

SOT-89 (TOP VIEW)

① - represents product series

MARK	PRODUCT SERIES
9	IXD1209xxxx

② - represents type of regulator

MARK				PRODUCT SERIES
VOUT 0.1 V INCREMENTS		VOUT 0.05 V INCREMENTS		
Voltage 0.1 – 3.0 V	Voltage 3.1 – 6.0 V	Voltage 0.15 – 3.05 V	Voltage 3.15 – 6.05 V	
V	A	E	L	IXD1209Axxxx
X	B	F	M	IXD1209Bxxxx
Y	C	H	N	IXD1209Cxxxx
Z	D	K	P	IXD1209Dxxxx
<u>V</u>	<u>A</u>	<u>E</u>	<u>L</u>	IXD1209Exxxx
<u>X</u>	<u>B</u>	<u>F</u>	<u>M</u>	IXD1209Fxxxx
<u>Y</u>	<u>C</u>	<u>H</u>	<u>N</u>	IXD1209Gxxxx
<u>Z</u>	<u>D</u>	<u>K</u>	<u>P</u>	IXD1209Hxxxx

□③ - represents output voltage

MARK	OUTPUT VOLTAGE, V			
0		3.1		3.15
1		3.2		3.25
2		3.3		3.35
3		3.4		3.45
4		3.5		3.55
5		3.6		3.65
6		3.7		3.75
7		3.8		3.85
8	0.9	3.9	0.95	3.95
9	1.0	4.0	1.05	4.05
A	1.1	4.1	1.15	4.15
B	1.2	4.2	1.25	4.25
C	1.3	4.3	1.35	4.35
D	1.4	4.4	1.45	4.45
E	1.5	4.5	1.55	4.55

MARK	OUTPUT VOLTAGE, V			
F	1.6	4.6	1.65	4.65
H	1.7	4.7	1.75	4.75
K	1.8	4.8	1.85	4.85
L	1.9	4.9	1.95	4.95
M	2.0	5.0	2.05	5.05
N	2.1	5.1	2.15	5.15
P	2.2	5.2	2.25	5.25
R	2.3	5.3	2.35	5.35
S	2.4	5.4	2.45	5.45
T	2.5	5.5	2.55	5.55
U	2.6	5.6	2.65	5.65
V	2.7	5.7	2.75	5.75
X	2.8	5.8	2.85	5.85
Y	2.9	5.9	2.95	5.95
Z	3.0	6.0	3.05	6.05

④ - represents production lot number 0 to 9, A to Z repeated (G, I, J, O, Q, W excluded)

MARKING (Continue)

IXD1209

USP-6B

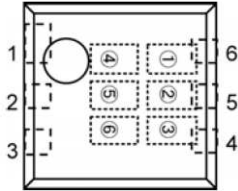

USP-6B
(TOP VIEW)

①② - represents product series

MARK		PRODUCT SERIES
①	②	
0	9	IXD1209xxxxDx

③ - represents type of regulator

MARK	TYPE	PRODUCT SERIES
A	CE pin, Active High pull-down resistor built in	IXD1209AxxxDx
B	CE pin, Active High no pull-down resistor built in	IXD1209BxxxDx
C	CE pin, Active Low pull-up resistor built in	IXD1209CxxxDx
D	CE pin, Active Low no pull-up resistor built in	IXD1209DxxxDx

④ - represents integer of the output voltage

MARK	VOLTAGE, V	PRODUCT SERIES
3	3.x	IXD1209x3xxDx
5	5.x	IXD1209x5xxDx

⑤ - represents decimal number of the output voltage

MARK	VOLTAGE, V	PRODUCT SERIES	MARK	VOLTAGE, V	PRODUCT SERIES
0	x.0	IXD1209xx0xDx	A	x.05	IXD1209xx0ADx
1	x.1	IXD1209xx1xDx	B	x.15	IXD1209xx1ADx
2	x.2	IXD1209xx2xDx	C	x.25	IXD1209xx2ADx
3	x.3	IXD1209xx3xDx	D	x.35	IXD1209xx3ADx
4	x.4	IXD1209xx4xDx	E	x.45	IXD1209xx4ADx
5	x.5	IXD1209xx5xDx	F	x.55	IXD1209xx5ADx
6	x.6	IXD1209xx6xDx	H	x.65	IXD1209xx6ADx
7	x.7	IXD1209xx7xDx	K	x/75	IXD1209xx7ADx
8	x.8	IXD1209xx8xDx	L	x.85	IXD1209xx8ADx
9	x.9	IXD1209xx9xDx	M	x.95	IXD1209xx9ADx

⑥ - represents production lot number 0 to 9, A to Z repeated (G, I, J, O, Q, W excluded)

MARKING

IXD1212

SOT-25

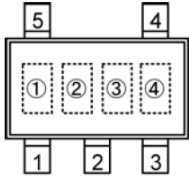

SOT-25 (TOP VIEW)

① - represents product series

MARK	PRODUCT SERIES
9	IXD1212xxxMx

② - represents type of regulator

MARK				PRODUCT SERIES
VOUT 0.1 V INCREMENTS		VOUT 0.05 V INCREMENTS		
Voltage 0.1 – 3.0 V	Voltage 3.1 – 6.0 V	Voltage 0.15 – 3.05 V	Voltage 3.15 – 6.05 V	
V	A	E	L	IXD1212AxxxMx
X	B	F	M	IXD1212BxxxMx
Y	C	H	N	IXD1212CxxxMx
Z	D	K	P	IXD1212DxxxMx

③ - represents output voltage

MARK	OUTPUT VOLTAGE, V			
0		3.1		3.15
1		3.2		3.25
2		3.3		3.35
3		3.4		3.45
4		3.5		3.55
5		3.6		3.65
6		3.7		3.75
7		3.8		3.85
8	0.9	3.9	0.95	3.95
9	1.0	4.0	1.05	4.05
A	1.1	4.1	1.15	4.15
B	1.2	4.2	1.25	4.25
C	1.3	4.3	1.35	4.35
D	1.4	4.4	1.45	4.45
E	1.5	4.5	1.55	4.55

MARK	OUTPUT VOLTAGE, V			
F	1.6	4.6	1.65	4.65
H	1.7	4.7	1.75	4.75
K	1.8	4.8	1.85	4.85
L	1.9	4.9	1.95	4.95
M	2.0	5.0	2.05	5.05
N	2.1	5.1	2.15	5.15
P	2.2	5.2	2.25	5.25
R	2.3	5.3	2.35	5.35
S	2.4	5.4	2.45	5.45
T	2.5	5.5	2.55	5.55
U	2.6	5.6	2.65	5.65
V	2.7	5.7	2.75	5.75
X	2.8	5.8	2.85	5.85
Y	2.9	5.9	2.95	5.95
Z	3.0	6.0	3.05	6.05

④ - represents production lot number 0 to 9, A to Z repeated (G, I, J, O, Q, W excluded)

Warranty and Use

IXYS CORP. MAKES NO WARRANTY, REPRESENTATION OR GUARANTEE, EXPRESS OR IMPLIED, REGARDING THE SUITABILITY OF ITS PRODUCTS FOR ANY PARTICULAR PURPOSE, NOR THAT THE USE OF ITS PRODUCTS WILL NOT INFRINGE ITS INTELLECTUAL PROPERTY RIGHTS OR THE RIGHTS OF THIRD PARTIES WITH RESPECT TO ANY PARTICULAR USE OR APPLICATION AND SPECIFICALLY DISCLAIMS ANY AND ALL LIABILITY ARISING OUT OF ANY SUCH USE OR APPLICATION, INCLUDING BUT NOT LIMITED TO, CONSEQUENTIAL OR INCIDENTAL DAMAGES.

IXYS Corp. products are not designed, intended, or authorized for use as components in systems intended for surgical implant into the body, or other applications intended to support or sustain life, or for any other application in which the failure of the IXYS Corp. product could create a situation where personal injury or death may occur.

IXYS Corp. reserves the right to make changes to or discontinue any product or service described herein without notice. Products with data sheets labeled "Advance Information" or "Preliminary" and other products described herein may not be in production or offered for sale.

IXYS Corp. advises customers to obtain the current version of the relevant product information before placing orders. Circuit diagrams illustrate typical semiconductor applications and may not be complete.



IXYS Corp.
1590 Buckeye Dr.
Milpitas, CA 95035-7418
Phone: 408. 457.9000
Fax: 408. 496.0222
<http://www.ixys.com>

Document No:IXD1209/12_DS
Revision: N0
Issue date: 2/12/2014