

NPT³ IGBT

$I_{C25} = 36 \text{ A}$
 $V_{CES} = 1200 \text{ V}$
 $V_{CE(sat) \text{ typ}} = 2.6 \text{ V}$

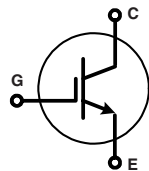

IXEH25N120

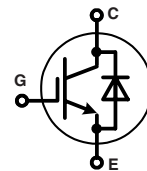

IXEH25N120D1

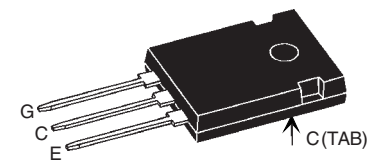
TO-247 AD

IGBT

Symbol	Conditions	Maximum Ratings	
V_{CES}	$T_{VJ} = 25^{\circ}\text{C to } 150^{\circ}\text{C}$	1200	V
V_{GES}		± 20	V
I_{C25}	$T_C = 25^{\circ}\text{C}$	36	A
I_{C90}	$T_C = 90^{\circ}\text{C}$	24	A
I_{CM} V_{CEK}	$V_{GE} = \pm 15 \text{ V}; R_G = 68 \Omega; T_{VJ} = 125^{\circ}\text{C}$ RBSOA, Clamped inductive load; $L = 100 \mu\text{H}$	60	A
		V_{CES}	
t_{SC} (SCSOA)	$V_{CE} = 900\text{V}; V_{GE} = \pm 15 \text{ V}; R_G = 68 \Omega; T_{VJ} = 125^{\circ}\text{C}$ non-repetitive	10	μs
P_{tot}	$T_C = 25^{\circ}\text{C}$	200	W

Features

- NPT³ IGBT
 - positive temperature coefficient of saturation voltage for easy paralleling
 - fast switching
 - short tail current for optimized performance in resonant circuits
- optional HiPerFRED™ diode
 - fast reverse recovery
 - low operating forward voltage
 - low leakage current
- TO-247 package
 - industry standard outline
 - epoxy meets UL 94V-0

Applications

- AC drives
- DC drives and choppers
- Uninterruptible power supplies (UPS)
- switched-mode and resonant-mode power supplies
- inductive heating, cookers

Symbol	Conditions	Characteristic Values ($T_{VJ} = 25^{\circ}\text{C}$, unless otherwise specified)			
		min.	typ.	max.	
$V_{CE(sat)}$	$I_C = 25 \text{ A}; V_{GE} = 15 \text{ V}; T_{VJ} = 25^{\circ}\text{C}$ $T_{VJ} = 125^{\circ}\text{C}$		2.6 3.2	V V	
$V_{GE(th)}$	$I_C = 0.6 \text{ mA}; V_{GE} = V_{CE}$	4.5		6.5 V	
I_{CES}	$V_{CE} = V_{CES}; V_{GE} = 0 \text{ V}; T_{VJ} = 25^{\circ}\text{C}$ $T_{VJ} = 125^{\circ}\text{C}$		0.2	mA mA	
I_{GES}	$V_{CE} = 0 \text{ V}; V_{GE} = \pm 20 \text{ V}$			200 nA	
$t_{d(on)}$ t_r $t_{d(off)}$ t_f E_{on} E_{off}	Inductive load, $T_{VJ} = 125^{\circ}\text{C}$ $V_{CE} = 600 \text{ V}; I_C = 20 \text{ A}$ $V_{GE} = \pm 15 \text{ V}; R_G = 68 \Omega$		205 105 320 175 4.1 1.5	ns ns ns ns mJ mJ	
C_{ies}		$V_{CE} = 25 \text{ V}; V_{GE} = 0 \text{ V}; f = 1 \text{ MHz}$		1.2	nF
Q_{Gon}		$V_{CE} = 600 \text{ V}; V_{GE} = 15 \text{ V}; I_C = 20 \text{ A}$		100	nC
R_{thJC}					0.63 KW

Diode [D1 version only]

Symbol	Conditions	Maximum Ratings	
I_{F25}	$T_C = 25^\circ\text{C}$	31	A
I_{F90}	$T_C = 90^\circ\text{C}$	19	A

Symbol	Conditions	Characteristic Values		
		min.	typ.	max.
V_F	$I_F = 25\text{ A}; T_{VJ} = 25^\circ\text{C}$ $T_{VJ} = 125^\circ\text{C}$	2.7	3.2	V
		2.1		V
I_{RM} t_{rr}	$I_F = 15\text{ A}; di_F/dt = -400\text{ A}/\mu\text{s}; T_{VJ} = 125^\circ\text{C}$ $V_R = 600\text{ V}; V_{GE} = 0\text{ V}$	16		A
		130		ns
R_{thJC}				1.6 K/W

Component

Symbol	Conditions	Maximum Ratings	
T_{VJ}		-55...+150	$^\circ\text{C}$
T_{stg}		-55...+150	$^\circ\text{C}$
M_d	mounting torque	0.8...1.2	Nm

Symbol	Conditions	Characteristic Values		
		min.	typ.	max.
R_{thCH}	with heatsink compound	0.25		K/W
Weight		6		g

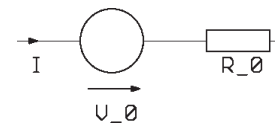
Equivalent Circuits for Simulation
Conduction

IGBT (typ. at $V_{GE} = 15\text{ V}; T_J = 125^\circ\text{C}$)
 $V_0 = 1.09\text{ V}; R_0 = 85\text{ m}\Omega$

Free Wheeling Diode (typ. at $T_J = 125^\circ\text{C}$)
 $V_0 = 1.3\text{ V}; R_0 = 32\text{ m}\Omega$

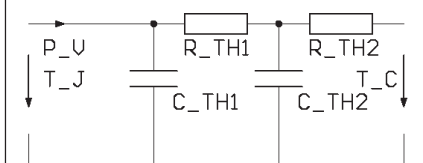
Thermal Response

IGBT (typ.)
 $C_{th1} = 0.004\text{ J/K}; R_{th1} = 0.335\text{ K/W}$
 $C_{th2} = 0.133\text{ J/K}; R_{th2} = 0.295\text{ K/W}$

Free Wheeling Diode (typ.)
 $C_{th1} = 0.004\text{ J/K}; R_{th1} = 1.076\text{ K/W}$
 $C_{th2} = 0.078\text{ J/K}; R_{th2} = 0.524\text{ K/W}$

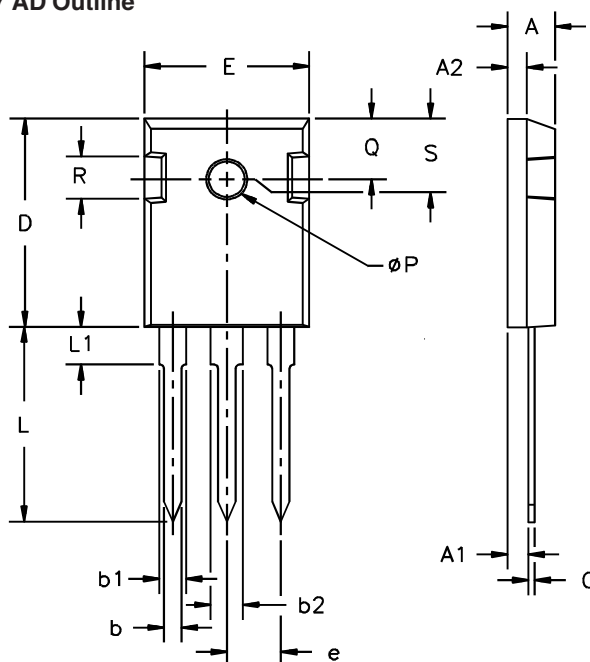
TO-247 AD Outline

Dim.	Millimeter		Inches	
	Min.	Max.	Min.	Max.
A	4.7	5.3	.185	.209
A ₁	2.2	2.54	.087	.102
A ₂	2.2	2.6	.059	.098
b	1.0	1.4	.040	.055
b ₁	1.65	2.13	.065	.084
b ₂	2.87	3.12	.113	.123
C	.4	.8	.016	.031
D	20.80	21.46	.819	.845
E	15.75	16.26	.610	.640
e	5.20	5.72	0.205	0.225
L	19.81	20.32	.780	.800
L1		4.50		.177
∅P	3.55	3.65	.140	.144
Q	5.89	6.40	0.232	0.252
R	4.32	5.49	.170	.216
S	6.15	BSC	.242	BSC

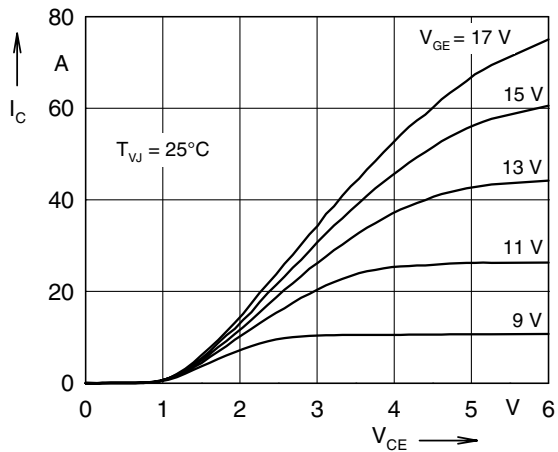

Fig. 1 Typ. output characteristics

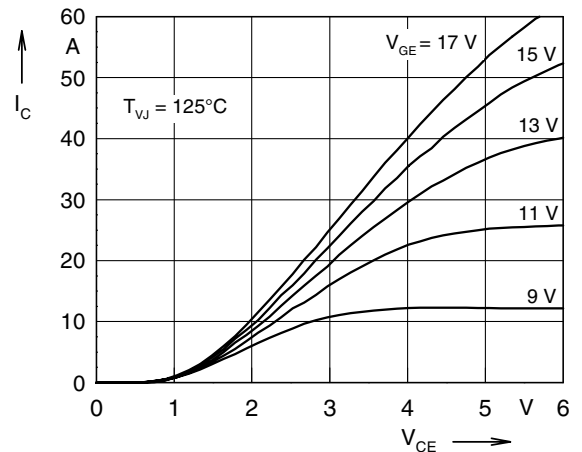

Fig. 2 Typ. output characteristics

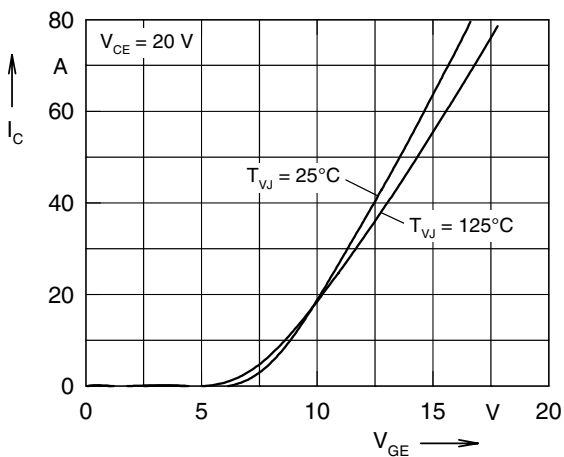

Fig. 3 Typ. transfer characteristics

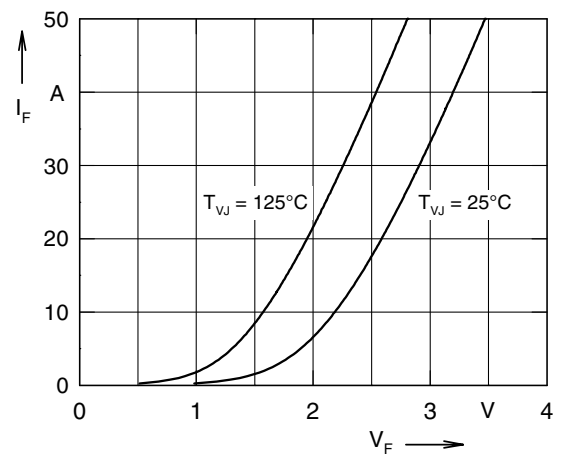

Fig. 4 Typ. forward characteristics of free wheeling diode

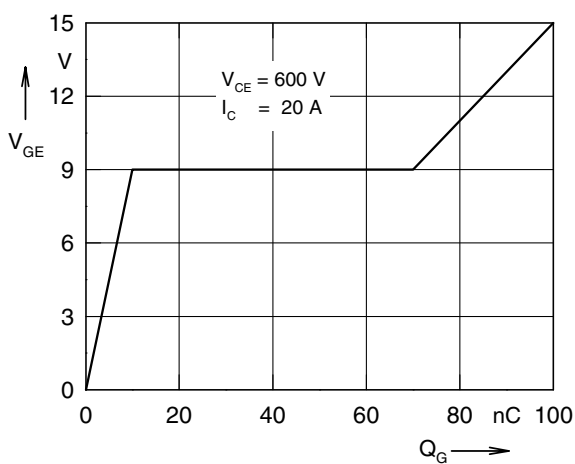

Fig. 5 Typ. turn on gate charge

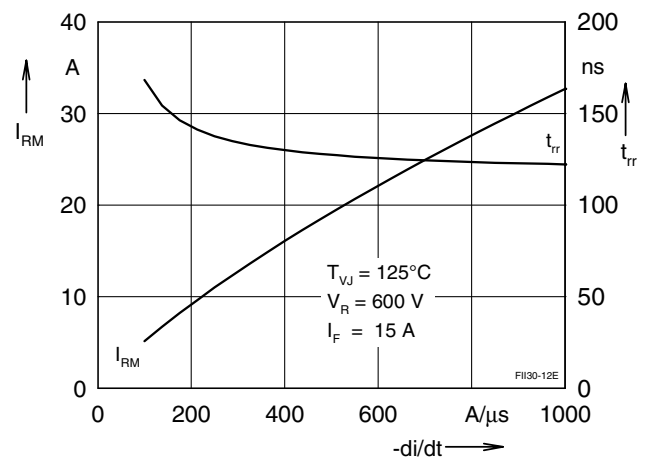

Fig. 6 Typ. turn off characteristics of free wheeling diode

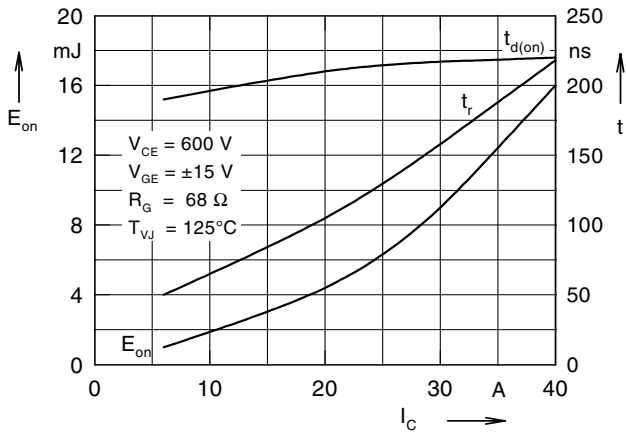

Fig. 7 Typ. turn on energy and switching times versus collector current

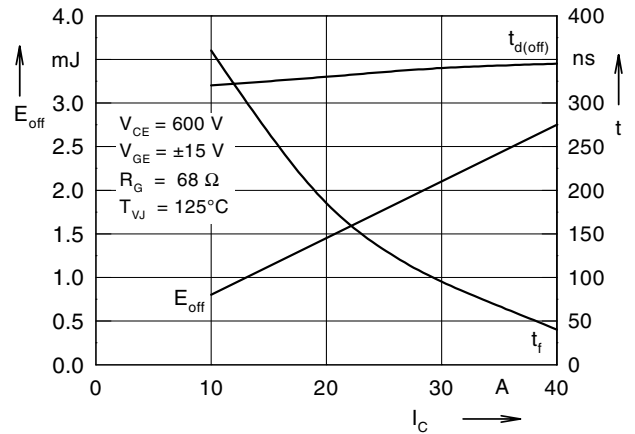

Fig. 8 Typ. turn off energy and switching times versus collector current

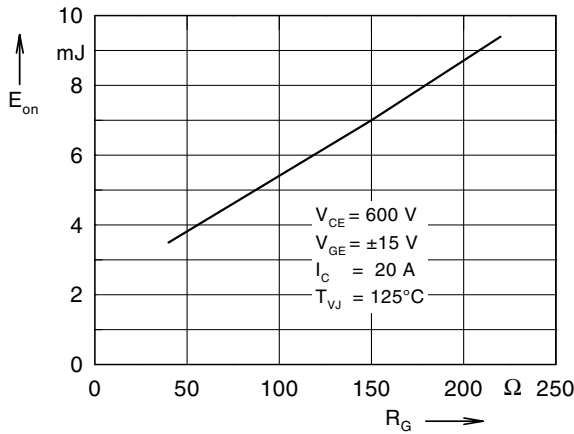

Fig. 9 Typ. turn on energy vs gate resistor

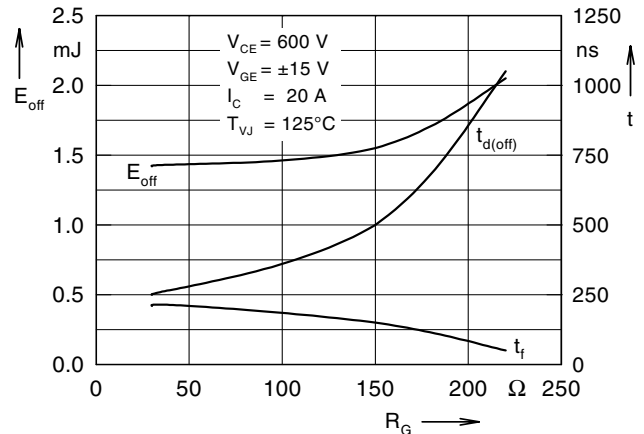

Fig.10 Typ. turn off energy and switching times versus gate resistor

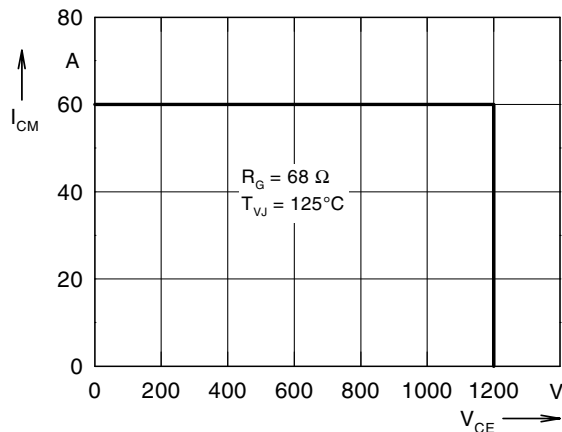

Fig. 11 Reverse biased safe operating area RBSOA

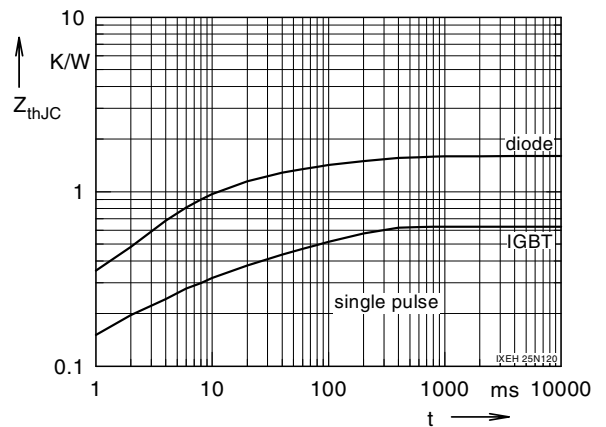

Fig. 12 Typ. transient thermal impedance