

PolarHV™ HiPerFET Power MOSFET

IXFC14N60P

(Electrically Isolated Back Surface)

N-Channel Enhancement Mode
Avalanche Rated
Fast Intrinsic Diode

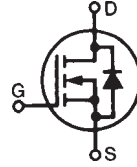

$$\begin{aligned} V_{DSS} &= 600V \\ I_{D25} &= 8A \\ R_{DS(on)} &\leq 630m\Omega \\ t_{rr} &\leq 200ns \end{aligned}$$

| Symbol | Test Conditions | Maximum Ratings | |
|---------------|--|------------------------|--------------------------|
| V_{DSS} | $T_J = 25^\circ C$ to $150^\circ C$ | 600 | V |
| V_{DGR} | $T_J = 25^\circ C$ to $150^\circ C$, $R_{GS} = 1M\Omega$ | 600 | V |
| V_{GSS} | Continuous | ± 30 | V |
| V_{GSM} | Transient | ± 40 | V |
| I_{D25} | $T_C = 25^\circ C$ | 8 | A |
| I_{DM} | $T_C = 25^\circ C$, pulse width limited by T_{JM} | 42 | A |
| I_A | $T_C = 25^\circ C$ | 14 | A |
| E_{AS} | $T_C = 25^\circ C$ | 900 | mJ |
| dV/dt | $I_S \leq I_{DM}$, $V_{DD} \leq V_{DSS}$, $T_J \leq 150^\circ C$ | 10 | V/ns |
| P_D | $T_C = 25^\circ C$ | 125 | W |
| T_J | | -55 ... +150 | $^\circ C$ |
| T_{JM} | | 150 | $^\circ C$ |
| T_{stg} | | -55 ... +150 | $^\circ C$ |
| T_L | 1.6mm (0.062 in.) from case for 10s | 300 | $^\circ C$ |
| T_{SOLD} | Plastic body for 10s | 260 | $^\circ C$ |
| V_{ISOL} | 50/60 Hz, RMS $I_{ISOL} \leq 1mA$ | $t = 1min$ $t = 1s$ | 2500 3000 V~ V~ |
| M_d | Mounting force | 11..66 / 2.5..14.6 | N/lb. |
| Weight | | 2 | g |

ISOPLUS 220™

 E153432

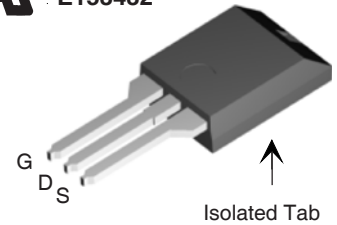

G = Gate D = Drain
S = Source

Features

- UL recognized package
- Silicon chip on Direct-Copper-Bond substrate
 - High power dissipation
 - Isolated mounting surface
 - 2500V electrical isolation
- Avalanche rated
- Fast intrinsic diode

Advantages

- Easy to mount
- Space savings
- High power density

Applications:

- Switched-mode and resonant-mode power supplies
- DC-DC Converters
- Laser Drivers
- AC and DC motor drives
- Robotics and servo controls

| Symbol | Test Conditions ($T_J = 25^\circ C$, unless otherwise specified) | Characteristic Values | | |
|--------------|---|-----------------------|------|--------------------------|
| | | Min. | Typ. | Max. |
| BV_{DSS} | $V_{GS} = 0V$, $I_D = 250\mu A$ | 600 | | V |
| $V_{GS(th)}$ | $V_{DS} = V_{GS}$, $I_D = 2.5mA$ | 3.0 | | 5.5 V |
| I_{GSS} | $V_{GS} = \pm 30V$, $V_{DS} = 0V$ | | | ± 100 nA |
| I_{DSS} | $V_{DS} = V_{DSS}$ $V_{GS} = 0V$ $T_J = 125^\circ C$ | | | 5 μA 500 μA |
| $R_{DS(on)}$ | $V_{GS} = 10V$, $I_D = 7A$, Note 1 | | | 630 $m\Omega$ |

| Symbol | Test Conditions ($T_J = 25^\circ\text{C}$, unless otherwise specified) | Characteristic Values | | |
|--------------|---|-----------------------|------|--------------------|
| | | Min. | Typ. | Max. |
| g_{fs} | $V_{DS} = 20\text{V}$, $I_D = 7\text{A}$, Note 1 | 7 | 13 | S |
| C_{iss} | $V_{GS} = 0\text{V}$, $V_{DS} = 25\text{V}$, $f = 1\text{MHz}$ | | 2500 | pF |
| C_{oss} | | | 215 | pF |
| C_{rss} | | | 13 | pF |
| $t_{d(on)}$ | Resistive Switching Times $V_{GS} = 10\text{V}$, $V_{DS} = 0.5 \cdot V_{DSS}$, $I_D = 7\text{A}$ $R_G = 10\Omega$ (External) | | 23 | ns |
| t_r | | | 27 | ns |
| $t_{d(off)}$ | | | 70 | ns |
| t_f | | | 26 | ns |
| $Q_{g(on)}$ | $V_{GS} = 10\text{V}$, $V_{DS} = 0.5 \cdot V_{DSS}$, $I_D = 7\text{A}$ | | 36 | nC |
| Q_{gs} | | | 16 | nC |
| Q_{gd} | | | 12 | nC |
| R_{thJC} | | | 1.00 | $^\circ\text{C/W}$ |
| R_{thCS} | | 0.21 | | $^\circ\text{C/W}$ |

Source-Drain Diode

| Symbol | Test Conditions ($T_J = 25^\circ\text{C}$, unless otherwise specified) | Characteristic Values | | |
|----------|---|-----------------------|------|--------|
| | | Min. | Typ. | Max. |
| I_S | $V_{GS} = 0\text{V}$ | | | 14 A |
| I_{SM} | Repetitive, pulse width limited by T_{JM} | | | 42 A |
| V_{SD} | $I_F = I_S$, $V_{GS} = 0\text{V}$, Note 1 | | | 1.5 V |
| t_{rr} | $I_F = 14\text{A}$, $-di/dt = 100\text{A}/\mu\text{s}$ $V_R = 100\text{V}$, $V_{GS} = 0\text{V}$ | | | 200 ns |
| Q_{RM} | | | 6.0 | nC |
| I_{RM} | | | 0.6 | A |

Note 1: Pulse test, $t \leq 300\mu\text{s}$; duty cycle, $d \leq 2\%$.

ISOPLUS220™ (IXFC) Outline

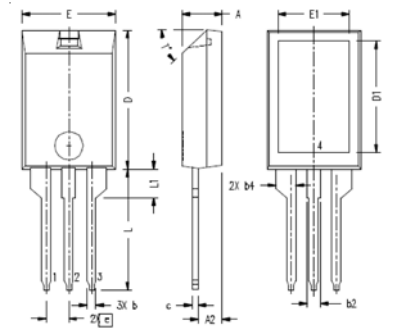

Note:
Bottom heatsink (Pin 4) is electrically isolated from Pin 1, 2, or 3.

| SYM | INCHES | | MILLIMETERS | |
|-----|------------|------|-------------|-------|
| | MIN | MAX | MIN | MAX |
| A | .157 | .197 | 4.00 | 5.00 |
| A2 | .098 | .118 | 2.50 | 3.00 |
| b | .035 | .051 | 0.90 | 1.30 |
| b2 | .049 | .065 | 1.25 | 1.65 |
| b4 | .093 | .100 | 2.35 | 2.55 |
| c | .028 | .039 | 0.70 | 1.00 |
| D | .591 | .630 | 15.00 | 16.00 |
| D1 | .472 | .512 | 12.00 | 13.00 |
| E | .394 | .433 | 10.00 | 11.00 |
| E1 | .295 | .335 | 7.50 | 8.50 |
| e | .100 BASIC | | 2.55 BASIC | |
| L | .512 | .571 | 13.00 | 14.50 |
| L1 | .118 | .138 | 3.00 | 3.50 |
| T* | | | 42.5* | 47.5* |

Ref: IXYS CO 0177 R0

IXYS reserves the right to change limits, test conditions, and dimensions.

| | | | | | | | | | | |
|--|-----------|-----------|-----------|-----------|--------------|--------------|--------------|--------------|--------------|-------------|
| IXYS MOSFETs and IGBTs are covered by one or more of the following U.S. patents: | 4,835,592 | 4,931,844 | 5,049,961 | 5,237,481 | 6,162,665 | 6,404,065 B1 | 6,683,344 | 6,727,585 | 7,005,734 B2 | 7,157,338B2 |
| | 4,850,072 | 5,017,508 | 5,063,307 | 5,381,025 | 6,259,123 B1 | 6,534,343 | 6,710,405 B2 | 6,759,692 | 7,063,975 B2 | |
| | 4,881,106 | 5,034,796 | 5,187,117 | 5,486,715 | 6,306,728 B1 | 6,583,505 | 6,710,463 | 6,771,478 B2 | 7,071,537 | |

Fig. 1. Output Characteristics @ 25°C

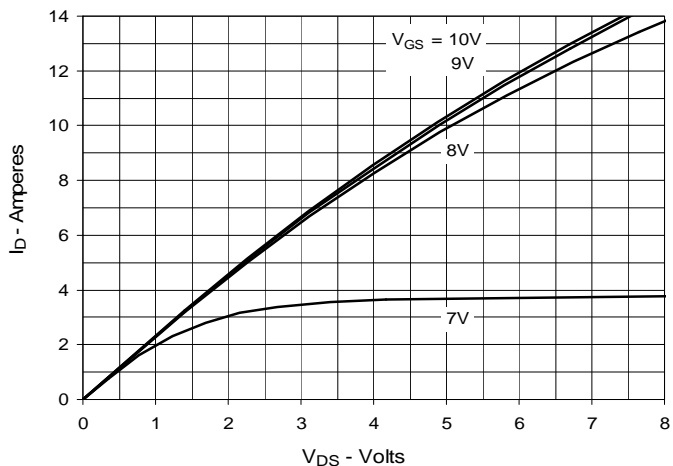

Fig. 2. Extended Output Characteristics @ 25°C

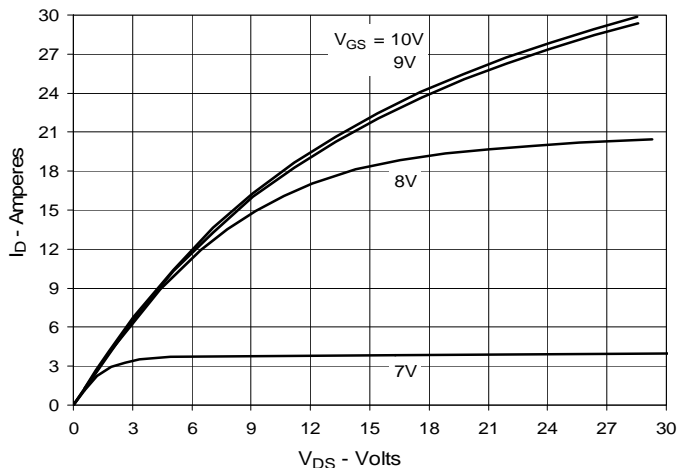

Fig. 3. Output Characteristics @ 125°C

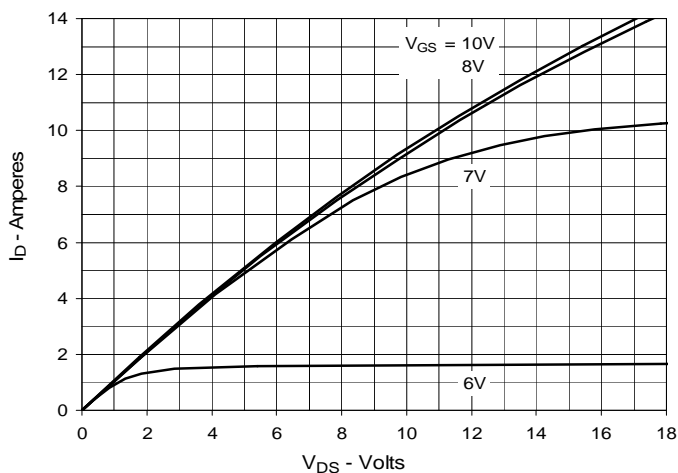

Fig. 4. $R_{DS(on)}$ Normalized to $I_D = 7A$ Value vs. Junction Temperature

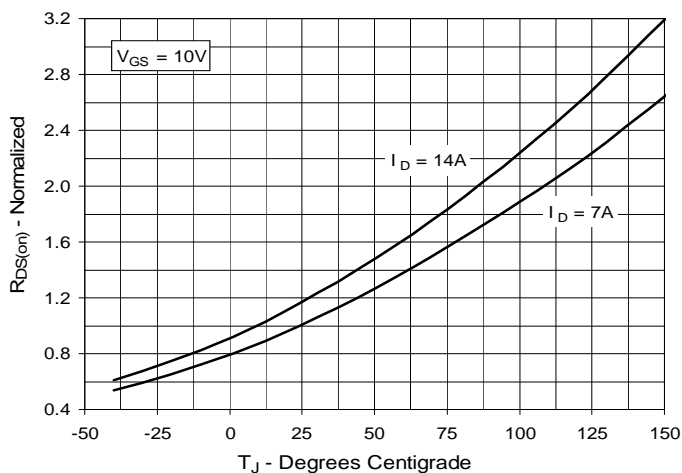

Fig. 5. $R_{DS(on)}$ Normalized to $I_D = 7A$ Value vs. Drain Current

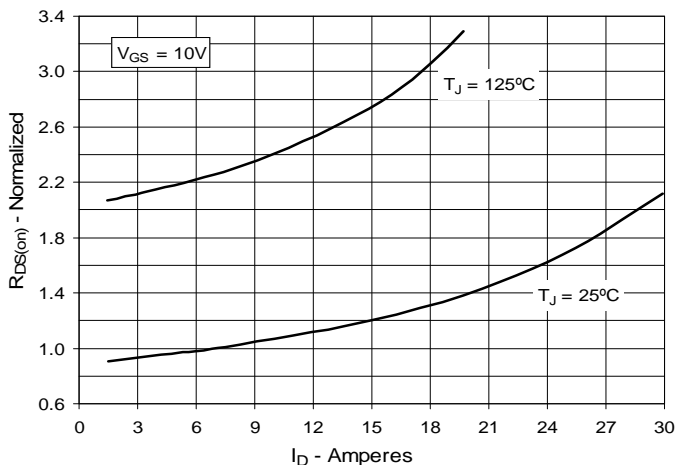

Fig. 6. Maximum Drain Current vs. Case Temperature

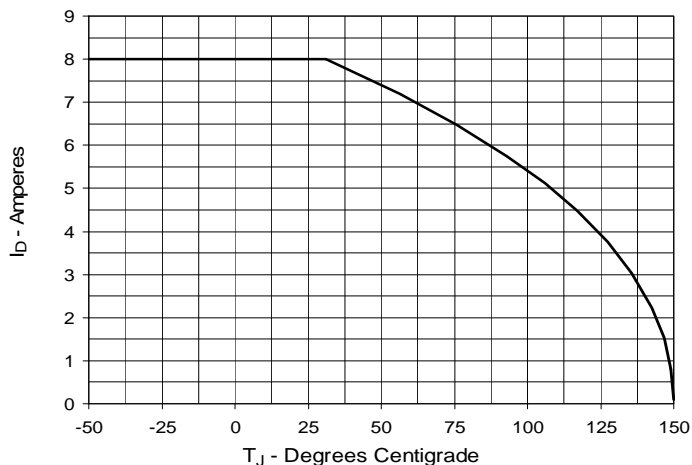

Fig. 7. Input Admittance

Fig. 8. Transconductance

Fig. 9. Forward Voltage Drop of Intrinsic Diode

Fig. 10. Gate Charge

Fig. 11. Capacitance

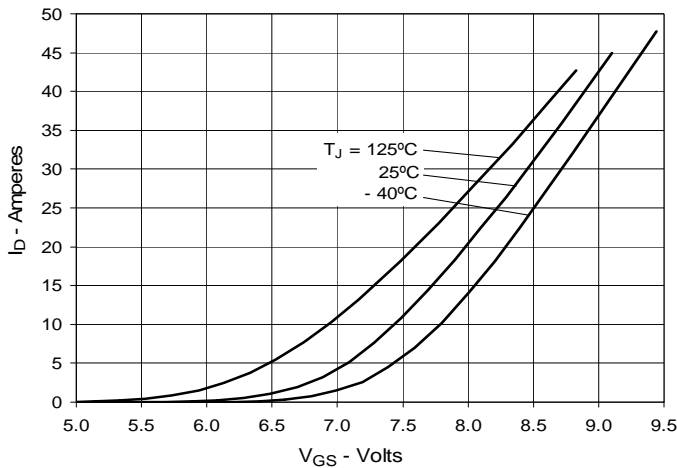
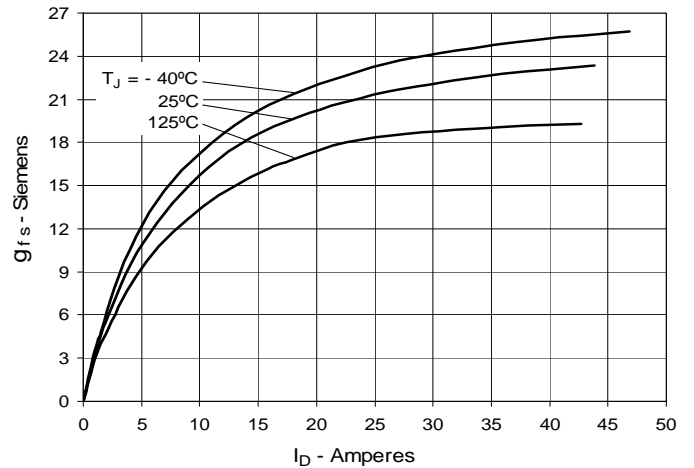
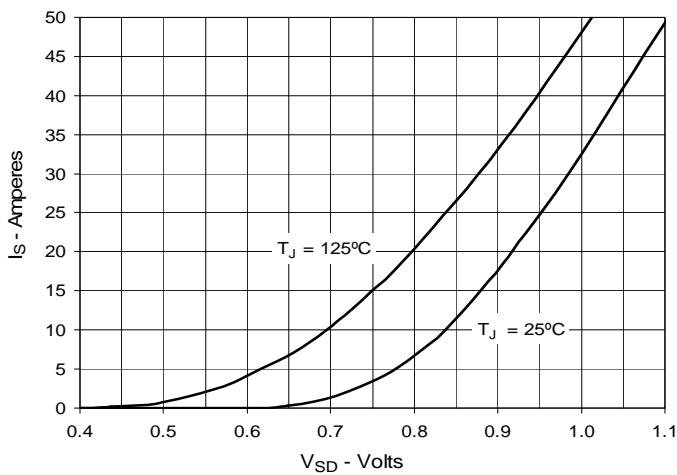
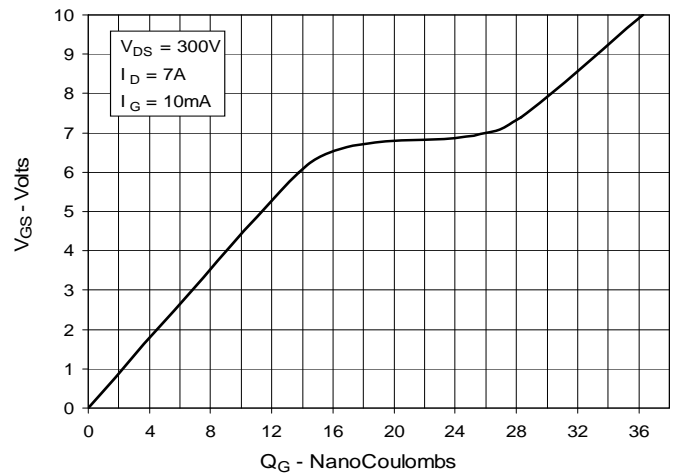
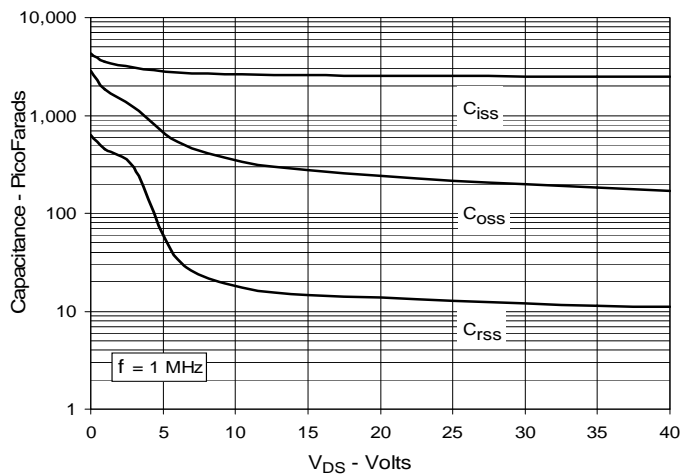
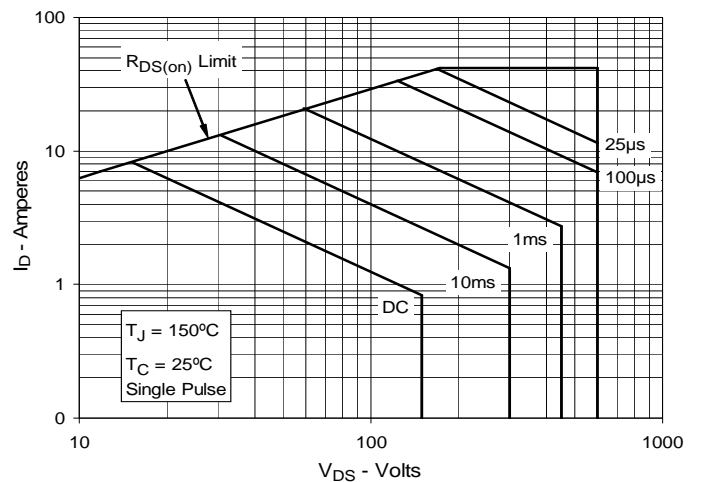
Fig. 12. Forward-Bias Safe Operating Area

Fig. 13. Maximum Transient Thermal Impedance

