

GigaMOS™ TrenchT2
HiperFET™
Power MOSFET

IXFK220N17T2
IXFX220N17T2

V_{DSS} = 170V
I_{D25} = 220A
R_{DS(on)} ≤ 6.3mΩ
t_{rr} ≤ 140ns

N-Channel Enhancement Mode
 Avalanche Rated
 Fast Intrinsic Diode



TO-264 (IXFK)

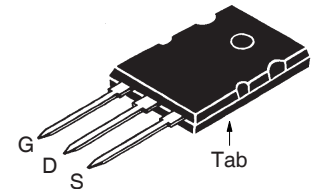

PLUS247 (IXFX)

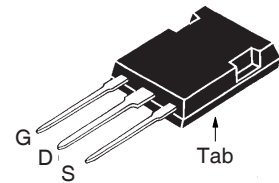

G = Gate D = Drain
 S = Source Tab = Drain

Symbol	Test Conditions	Maximum Ratings	
V _{DSS}	T _J = 25°C to 175°C	170	V
V _{DGR}	T _J = 25°C to 175°C, R _{GS} = 1MΩ	170	V
V _{GSS}	Continuous	± 20	V
V _{GSM}	Transient	± 30	V
I _{D25}	T _C = 25°C (Chip Capability)	220	A
I _{L(RMS)}	External Lead Current Limit	160	A
I _{DM}	T _C = 25°C, Pulse Width Limited by T _{JM}	550	A
I _A	T _C = 25°C	110	A
E _{AS}	T _C = 25°C	2	J
P _D	T _C = 25°C	1250	W
dv/dt	I _S ≤ I _{DM} , V _{DD} ≤ V _{DSS} , T _J ≤ 175°C	20	V/ns
T _J		-55 ... +175	°C
T _{JM}		175	°C
T _{stg}		-55 ... +175	°C
T _L	1.6mm (0.062 in.) from Case for 10s	300	°C
T _{SOLD}	Plastic Body for 10s	260	°C
M _d	Mounting Torque (TO-264)	1.13/10	Nm/lb.in.
F _C	Mounting Force (PLUS247)	20..120 / 4.5..27	N/lb.
Weight	TO-264	10	g
	PLUS247	6	g

Symbol	Test Conditions (T _J = 25°C Unless Otherwise Specified)	Characteristic Values		
		Min.	Typ.	Max.
BV _{DSS}	V _{GS} = 0V, I _D = 3mA	170		V
V _{GS(th)}	V _{DS} = V _{GS} , I _D = 8mA	2.5		5.0 V
I _{GSS}	V _{GS} = ± 20V, V _{DS} = 0V			± 200 nA
I _{DSS}	V _{DS} = V _{DSS} , V _{GS} = 0V T _J = 150°C			25 μA 3 mA
R _{DS(on)}	V _{GS} = 10V, I _D = 60A, Note 1	5.1		6.3 mΩ

Features

- High Current Handling Capability
- Fast Intrinsic Diode
- Avalanche Rated
- Low R_{DS(on)}

Advantages

- Easy to Mount
- Space Savings
- High Power Density

Applications

- Synchronous Rectification
- DC-DC Converters
- Battery Chargers
- Switch-Mode and Resonant-Mode Power Supplies
- DC Choppers
- AC Motor Drives
- Uninterruptible Power Supplies
- High Speed Power Switching Applications

Symbol	Test Conditions	Characteristic Values		
		Min.	Typ.	Max.
g_{fs}	$V_{DS} = 10V, I_D = 60A$, Note 1	105	175	S
C_{iss}	$V_{GS} = 0V, V_{DS} = 25V, f = 1MHz$		31	nF
C_{oss}			2130	pF
C_{rss}			290	pF
R_{Gi}	Gate Input Resistance		1.40	Ω
$t_{d(on)}$	Resistive Switching Times $V_{GS} = 10V, V_{DS} = 0.5 \cdot V_{DSS}, I_D = 0.5 \cdot I_{D25}$ $R_G = 1\Omega$ (External)		44	ns
t_r			160	ns
$t_{d(off)}$			40	ns
t_f			150	ns
$Q_{g(on)}$	$V_{GS} = 10V, V_{DS} = 0.5 \cdot V_{DSS}, I_D = 0.5 \cdot I_{D25}$		500	nC
Q_{gs}			130	nC
Q_{gd}			137	nC
R_{thJC}			0.12	$^{\circ}C/W$
R_{thCS}		0.15		$^{\circ}C/W$

Source-Drain Diode

Symbol	Test Conditions	Characteristic Values		
		Min.	Typ.	Max.
I_s	$V_{GS} = 0V$			220 A
I_{SM}	Repetitive, Pulse Width Limited by T_{JM}			880 A
V_{SD}	$I_F = 100A, V_{GS} = 0V$, Note 1			1.3 V
t_{rr}	$I_F = 110A, -di/dt = 100A/\mu s$ $V_R = 85V, V_{GS} = 0V$			140 ns
Q_{RM}			0.5	μC
I_{RM}			8.6	A

Note 1. Pulse test, $t \leq 300\mu s$, duty cycle, $d \leq 2\%$.

ADVANCE TECHNICAL INFORMATION

The product presented herein is under development. The Technical Specifications offered are derived from a subjective evaluation of the design, based upon prior knowledge and experience, and constitute a "considered reflection" of the anticipated result. IXYS reserves the right to change limits, test conditions, and dimensions without notice.

IXYS Reserves the Right to Change Limits, Test Conditions, and Dimensions.

IXYS MOSFETs and IGBTs are covered by one or more of the following U.S. patents:	4,835,592	4,931,844	5,049,961	5,237,481	6,162,665	6,404,065 B1	6,683,344	6,727,585	7,005,734 B2	7,157,338B2
	4,850,072	5,017,508	5,063,307	5,381,025	6,259,123 B1	6,534,343	6,710,405 B2	6,759,692	7,063,975 B2	
	4,881,106	5,034,796	5,187,117	5,486,715	6,306,728 B1	6,583,505	6,710,463	6,771,478 B2	7,071,537	

TO-264 (IXFK) Outline

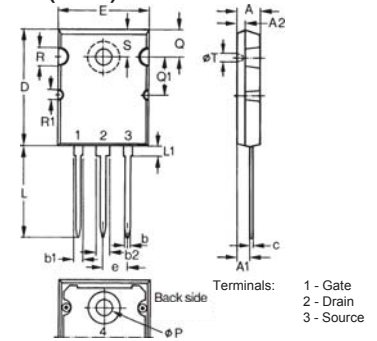

Dim.	Millimeter		Inches	
	Min.	Max.	Min.	Max.
A	4.82	5.13	.190	.202
A1	2.54	2.89	.100	.114
A2	2.00	2.10	.079	.083
b	1.12	1.42	.044	.056
b1	2.39	2.69	.094	.106
b2	2.90	3.09	.114	.122
c	0.53	0.83	.021	.033
D	25.91	26.16	1.020	1.030
E	19.81	19.96	.780	.786
e	5.46 BSC		.215 BSC	
J	0.00	0.25	.000	.010
K	0.00	0.25	.000	.010
L	20.32	20.83	.800	.820
L1	2.29	2.59	.090	.102
P	3.17	3.66	.125	.144
Q	6.07	6.27	.239	.247
Q1	8.38	8.69	.330	.342
R	3.81	4.32	.150	.170
R1	1.78	2.29	.070	.090
S	6.04	6.30	.238	.248
T	1.57	1.83	.062	.072

PLUS 247™ (IXFX) Outline

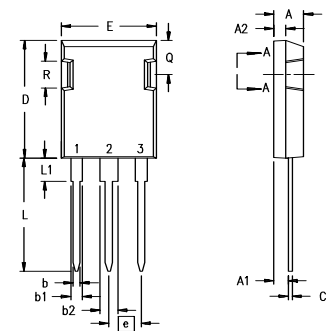

Dim.	Millimeter		Inches	
	Min.	Max.	Min.	Max.
A	4.83	5.21	.190	.205
A1	2.29	2.54	.090	.100
A2	1.91	2.16	.075	.085
b	1.14	1.40	.045	.055
b1	1.91	2.13	.075	.084
b2	2.92	3.12	.115	.123
C	0.61	0.80	.024	.031
D	20.80	21.34	.819	.840
E	15.75	16.13	.620	.635
e	5.45 BSC		.215 BSC	
L	19.81	20.32	.780	.800
L1	3.81	4.32	.150	.170
Q	5.59	6.20	.220	0.244
R	4.32	4.83	.170	.190

Fig. 1. Output Characteristics @ $T_J = 25^\circ\text{C}$

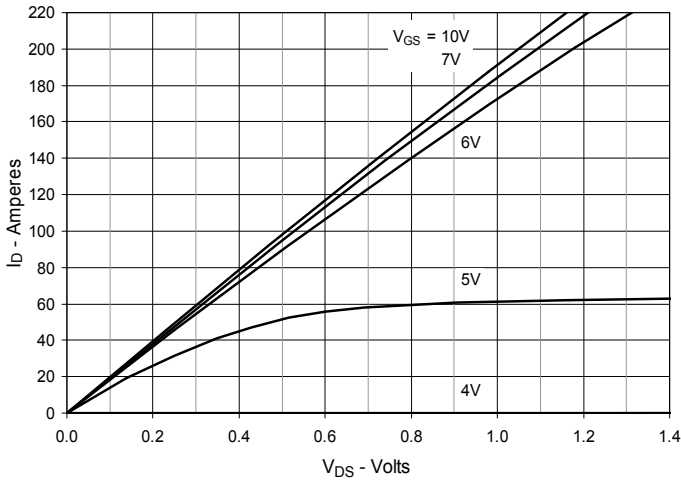

Fig. 2. Extended Output Characteristics @ $T_J = 25^\circ\text{C}$

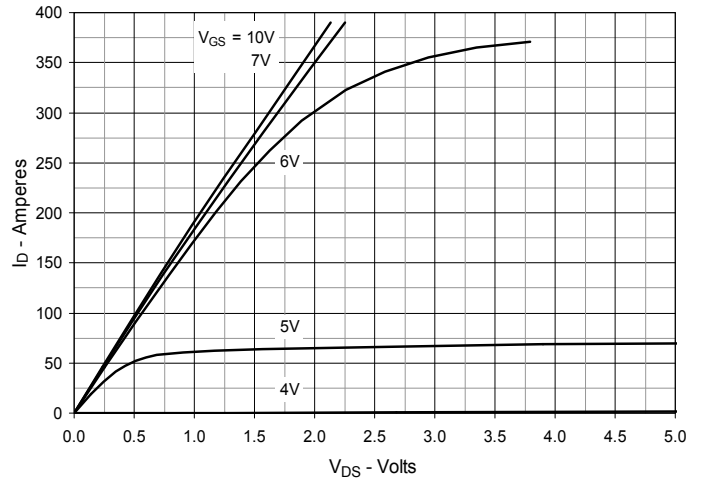

Fig. 3. Output Characteristics @ $T_J = 150^\circ\text{C}$

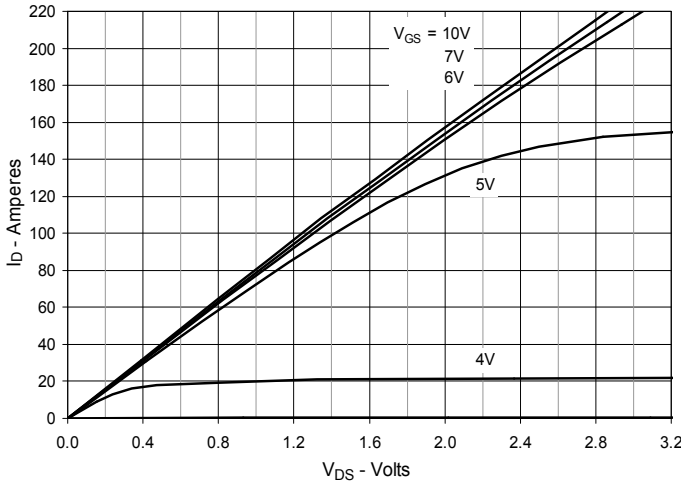

Fig. 4. $R_{DS(on)}$ Normalized to $I_D = 110\text{A}$ Value vs. Junction Temperature

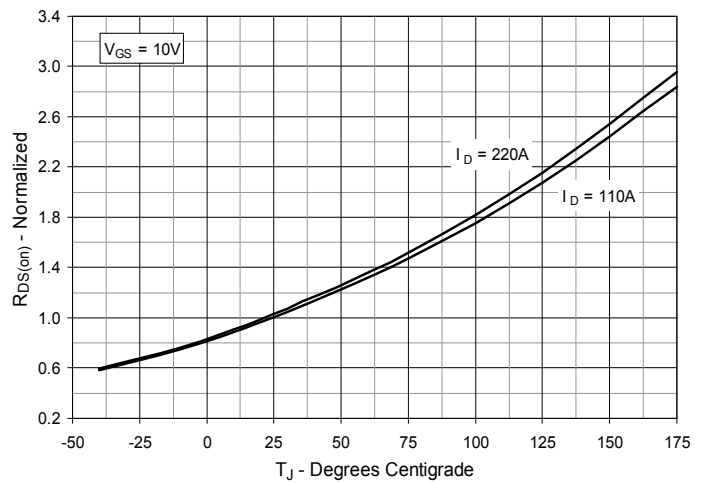

Fig. 5. Normalized $R_{DS(on)}$ $I_D = 110\text{A}$ Value vs. Drain Current

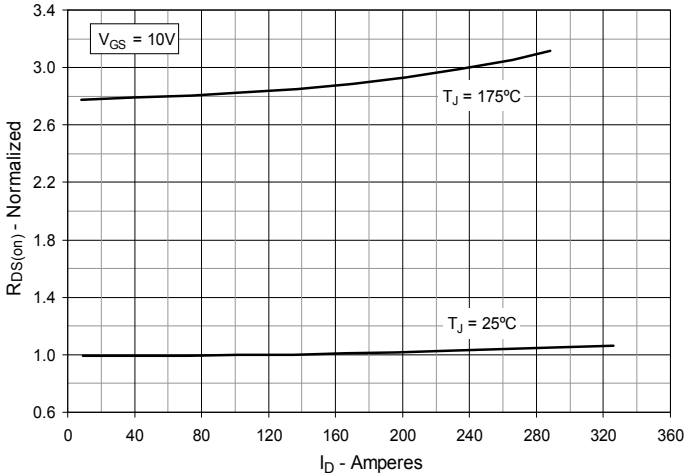

Fig. 6. Drain Current vs. Case Temperature

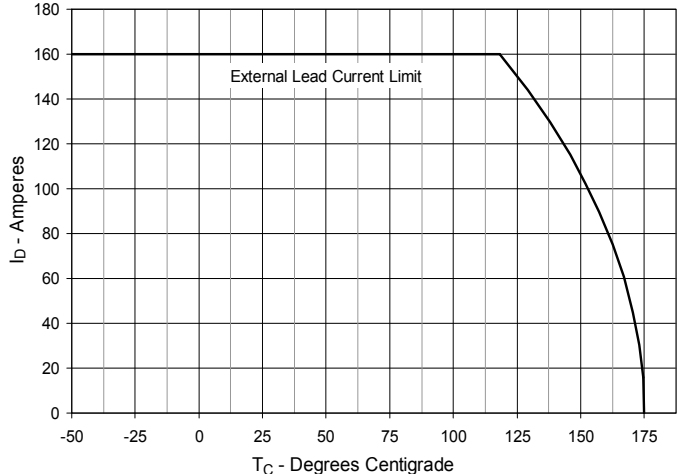

Fig. 7. Input Admittance

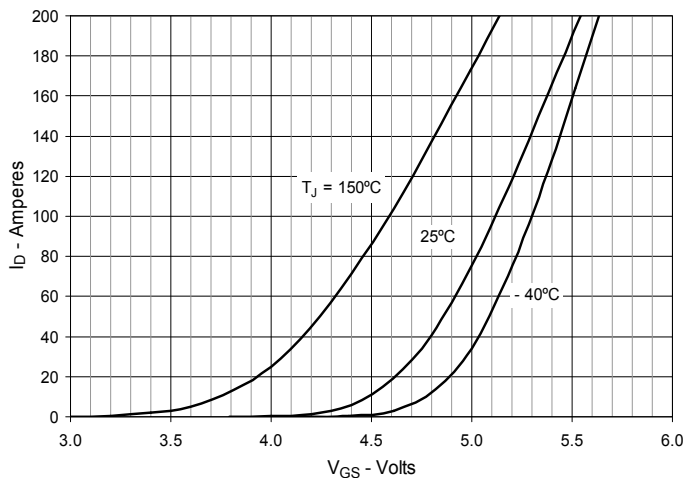

Fig. 8. Transconductance

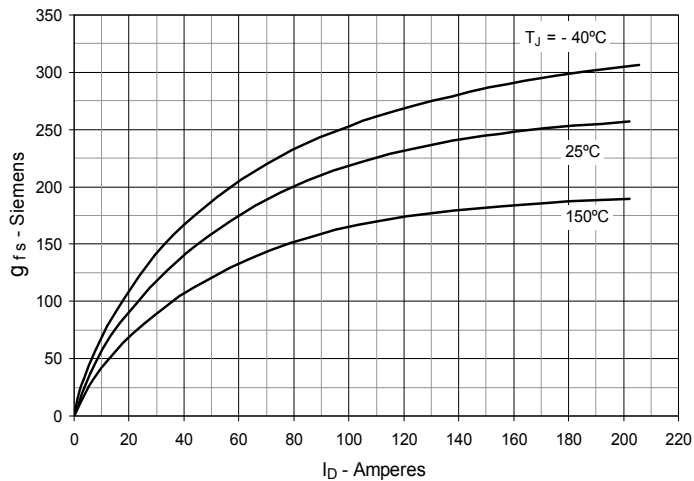

Fig. 9. Forward Voltage Drop of Intrinsic Diode

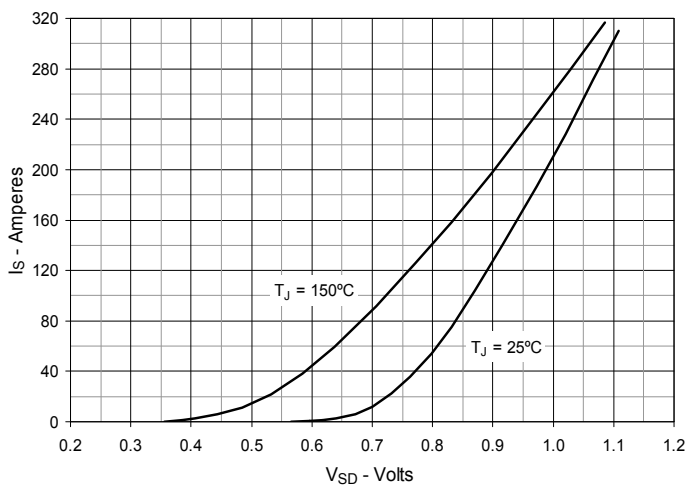

Fig. 10. Gate Charge

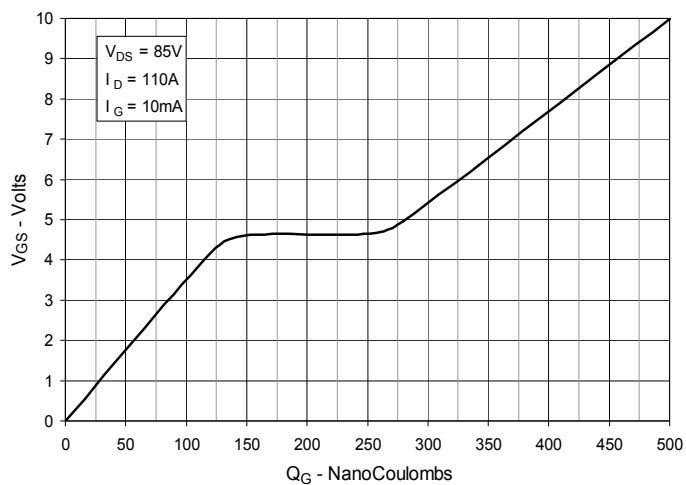

Fig. 11. Capacitance

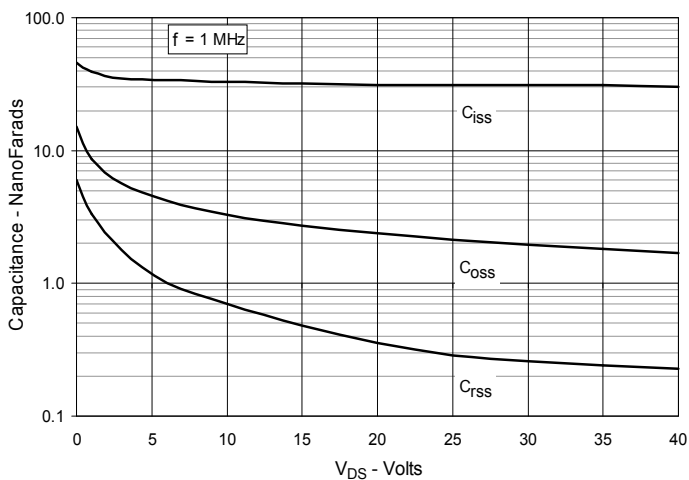

Fig. 12. Forward-Bias Safe Operating Area

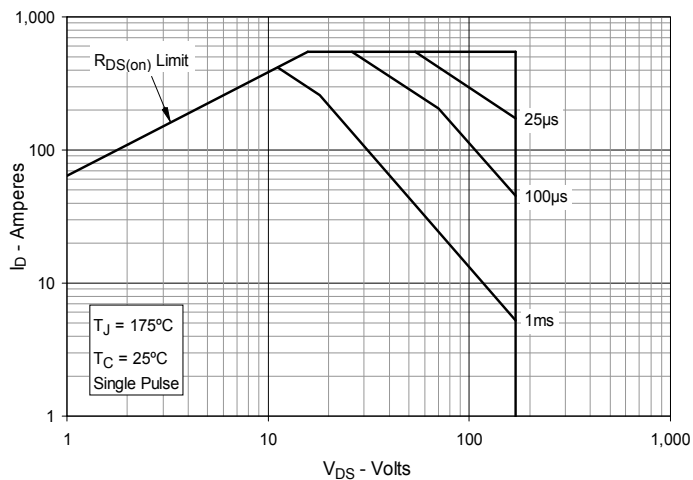

Fig. 13. Resistive Turn-on Rise Time vs. Junction Temperature

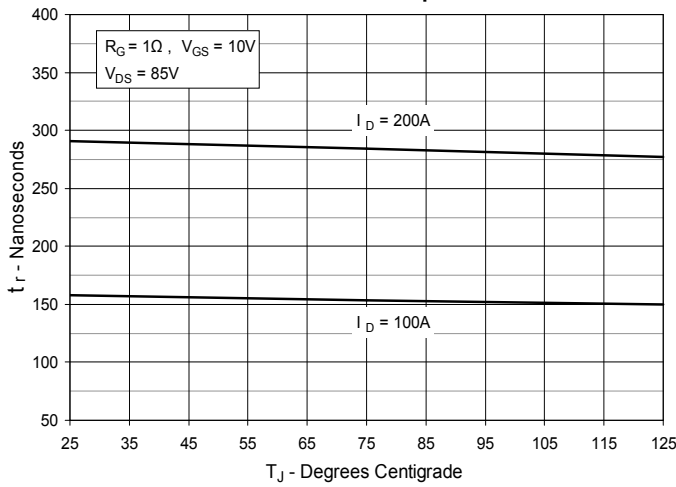

Fig. 14. Resistive Turn-on Rise Time vs. Drain Current

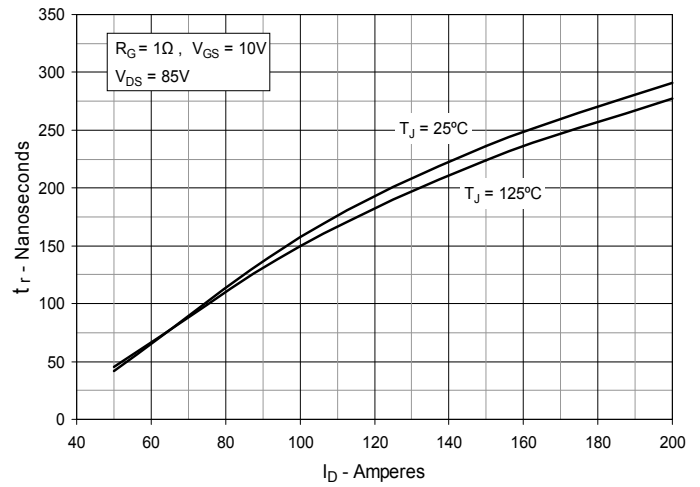

Fig. 15. Resistive Turn-on Switching Times vs. Gate Resistance

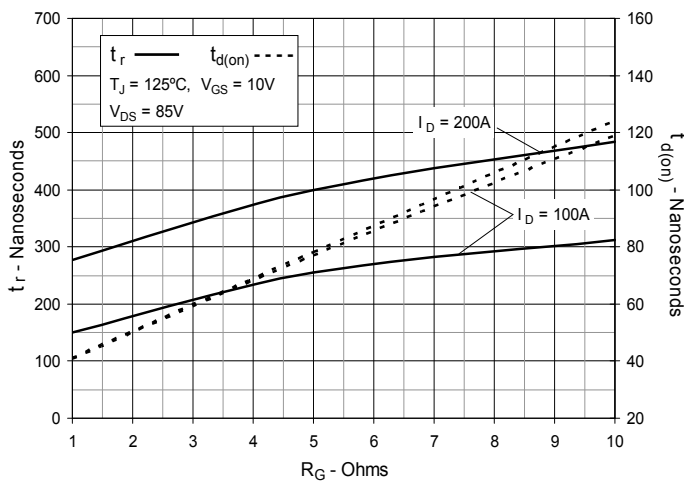

Fig. 16. Resistive Turn-off Switching Times vs. Junction Temperature

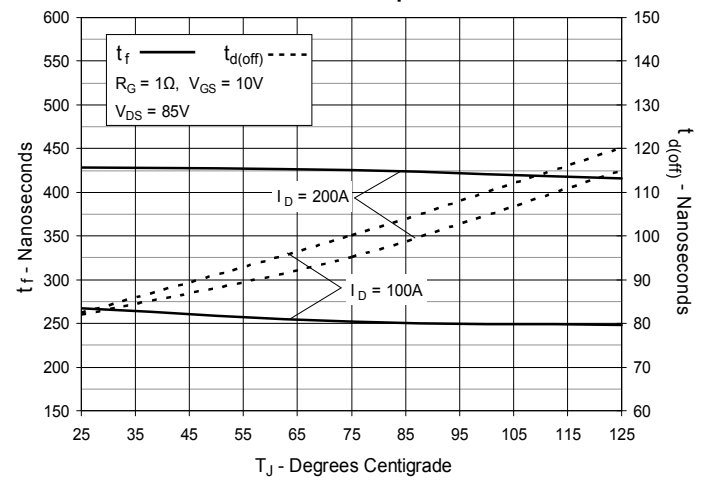

Fig. 17. Resistive Turn-off Switching Times vs. Drain Current

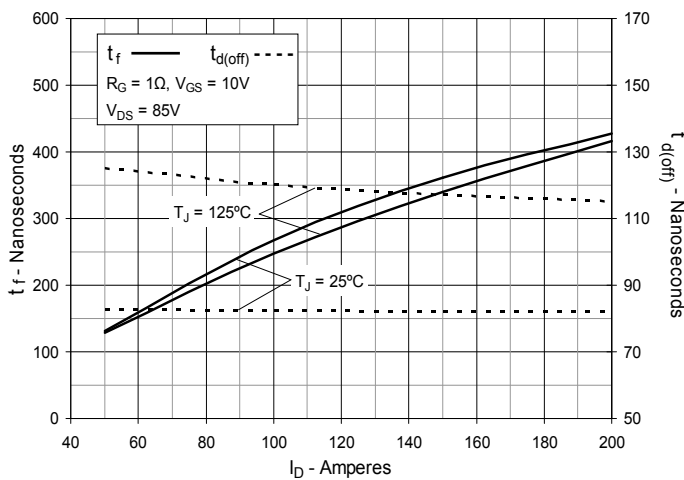

Fig. 18. Resistive Turn-off Switching Times vs. Gate Resistance

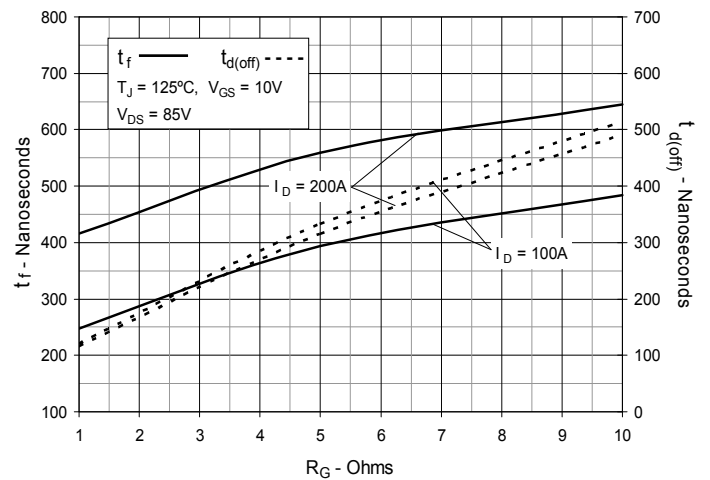

Fig. 19. Maximum Transient Thermal Impedance

