

Polar™ Power MOSFET

HiPerFET™

IXFL44N100P

N-Channel Enhancement Mode
Avalanche Rated
Fast Intrinsic Diode

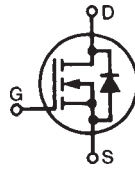

$V_{DSS} = 1000V$
 $I_{D25} = 22A$
 $R_{DS(on)} \leq 240m\Omega$
 $t_{rr} \leq 300ns$

ISOPLUS i5-Pak™ (HV)

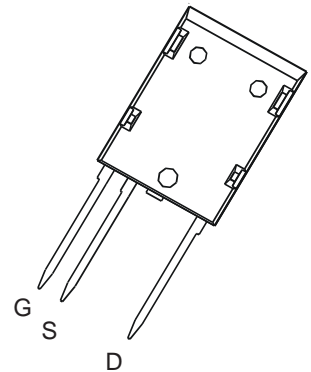

G = Gate
S = Source
D = Drain

Symbol	Test Conditions	Maximum Ratings	
		Value	Unit
V_{DSS}	$T_J = 25^\circ C$ to $150^\circ C$	1000	V
V_{DGR}	$T_J = 25^\circ C$ to $150^\circ C$, $R_{GS} = 1M\Omega$	1000	V
V_{GSS}	Continuous	± 30	V
V_{GSM}	Transient	± 40	V
I_{D25}	$T_C = 25^\circ C$	22	A
I_{DM}	$T_C = 25^\circ C$, pulse width limited by T_{JM}	110	A
I_{AR}	$T_C = 25^\circ C$	22	A
E_{AS}	$T_C = 25^\circ C$	2	J
dV/dt	$I_S \leq I_{DM}$, $V_{DD} \leq V_{DSS}$, $T_J \leq 150^\circ C$	15	V/ns
P_D	$T_C = 25^\circ C$	357	W
T_J		-55 ... +150	$^\circ C$
T_{JM}		150	$^\circ C$
T_{stg}		-55 ... +150	$^\circ C$
T_L	Maximum lead temperature for soldering	300	$^\circ C$
T_{SOLD}	Plastic body for 10s	260	$^\circ C$
V_{ISOL}	50/60 Hz, RMS, 1 minute	2500	V~
	$I_{ISOL} \leq 1mA$ $t = 1s$	3000	V~
F_C	Mounting force	40..120/4.5..27	N/lb.
Weight		8	g

Features

- Silicon chip on Direct-Copper-Bond substrate
 - High power dissipation
 - Isolated mounting surface
 - 2500V electrical isolation
- Low drain to tab capacitance(<30pF)
- Rugged polysilicon gate cell structure
- Unclamped Inductive Switching (UIS) rated
- Fast intrinsic Rectifier

Applications

- Switched-mode and resonant-mode power supplies
- DC-DC converters
- Laser Drivers
- AC and DC motor controls
- Robotics and servo controls

Advantages

- Easy assembly
- Space savings
- High power density

Symbol	Test Conditions	Characteristic Values		
		Min.	Typ.	Max.
BV_{DSS}	$V_{GS} = 0V$, $I_D = 3mA$	1000		V
$V_{GS(th)}$	$V_{DS} = V_{GS}$, $I_D = 1mA$	3.5		6.5 V
I_{GSS}	$V_{GS} = \pm 30V$, $V_{DS} = 0V$			± 200 nA
I_{DSS}	$V_{DS} = V_{DSS}$ $V_{GS} = 0V$ $T_J = 125^\circ C$			50 μA 3 mA
$R_{DS(on)}$	$V_{GS} = 10V$, $I_D = 22A$, Note 1			240 m Ω

Symbol	Test Conditions ($T_J = 25^\circ\text{C}$ unless otherwise specified)	Characteristic Values		
		Min.	Typ.	Max.
g_{fs}	$V_{DS} = 20\text{V}, I_D = 22\text{A}$, Note 1	20	35	S
C_{iss}	$V_{GS} = 0\text{V}, V_{DS} = 25\text{V}, f = 1\text{MHz}$		19	nF
C_{oss}			1060	pF
C_{rss}			41	pF
R_{Gi}	Gate input resistance		1.70	Ω
$t_{d(on)}$	Resistive Switching Times $V_{GS} = 10\text{V}, V_{DS} = 0.5 \cdot V_{DSS}, I_D = 22\text{A}$ $R_G = 1\Omega$ (External)		60	ns
t_r			68	ns
$t_{d(off)}$			90	ns
t_f			54	ns
$Q_{g(on)}$	$V_{GS} = 10\text{V}, V_{DS} = 0.5 \cdot V_{DSS}, I_D = 22\text{A}$		305	nC
Q_{gs}			104	nC
Q_{gd}			125	nC
R_{thJC}				0.35 $^\circ\text{C/W}$
R_{thCS}		0.15		$^\circ\text{C/W}$

Source-Drain Diode		Characteristic Values		
$T_J = 25^\circ\text{C}$ unless otherwise specified)		Min.	Typ.	Max.
I_S	$V_{GS} = 0\text{V}$			44 A
I_{SM}	Repetitive, pulse width limited by T_{JM}			176 A
V_{SD}	$I_F = I_S, V_{GS} = 0\text{V}$, Note 1			1.5 V
t_{rr}	$I_F = 22\text{A}, -di/dt = 100\text{A}/\mu\text{s}$ $V_R = 100\text{V}, V_{GS} = 0\text{V}$			300 ns
Q_{RM}			2.5	μC
I_{RM}			17	A

ISOPLUS i5-Pak™ HV (IXFL) Outline

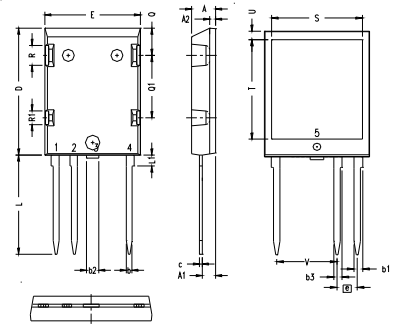

Note: Bottom heatsink meets 2500 Vrms isolation to the other pins.

SYM	INCHES		MILLIMETERS	
	MIN	MAX	MIN	MAX
A	.190	.205	4.83	5.21
A1	.102	.118	2.59	3.00
A2	.046	.055	1.17	1.40
b	.045	.055	1.14	1.40
b1	.063	.072	1.60	1.83
b2	.100	.110	2.54	2.79
b3	.058	.068	1.47	1.73
c	.020	.029	0.51	0.74
D	1.020	1.040	25.91	26.42
E	.770	.799	19.56	20.29
e	.150 BSC		3.81 BSC	
L	.780	.820	19.81	20.83
L1	.080	.102	2.03	2.59
Q	.210	.235	5.33	5.97
Q1	.490	.513	12.45	13.03
R	.150	.180	3.81	4.57
R1	.100	.130	2.54	3.30
S	.668	.690	16.97	17.53
T	.801	.821	20.34	20.85
U	.065	.080	1.65	2.03
V	.440	.460	11.18	11.68

Note 1: Pulse test, $t \leq 300\mu\text{s}$; duty cycle, $d \leq 2\%$.

IXYS reserves the right to change limits, test conditions, and dimensions.

IXYS MOSFETs and IGBTs are covered by one or more of the following U.S. patents:	4,835,592	4,931,844	5,049,961	5,237,481	6,162,665	6,404,065 B1	6,683,344	6,727,585	7,005,734 B2	7,157,338B2
	4,850,072	5,017,508	5,063,307	5,381,025	6,259,123 B1	6,534,343	6,710,405 B2	6,759,692	7,063,975 B2	
	4,881,106	5,034,796	5,187,117	5,486,715	6,306,728 B1	6,583,505	6,710,463	6,771,478 B2	7,071,537	

Fig. 1. Output Characteristics @ 25°C

Fig. 2. Extended Output Characteristics @ 25°C

Fig. 3. Output Characteristics @ 125°C

Fig. 4. $R_{DS(on)}$ Normalized to $I_D = 22A$ Value vs. Junction Temperature

Fig. 5. $R_{DS(on)}$ Normalized to $I_D = 22A$ Value vs. Drain Current

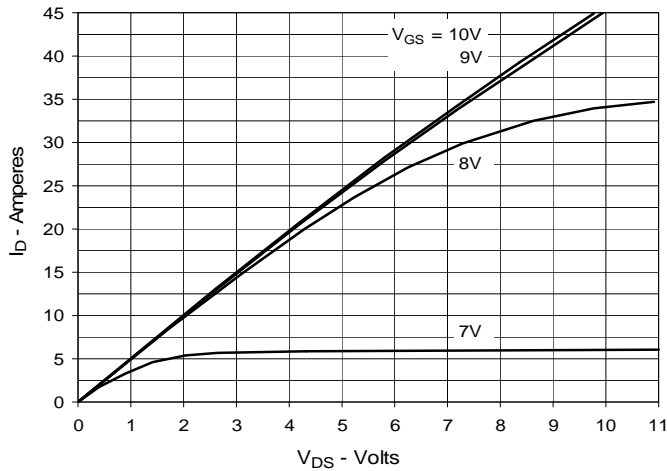
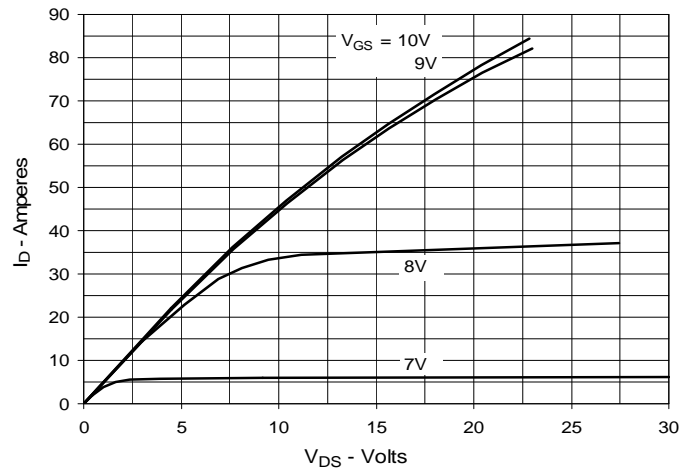
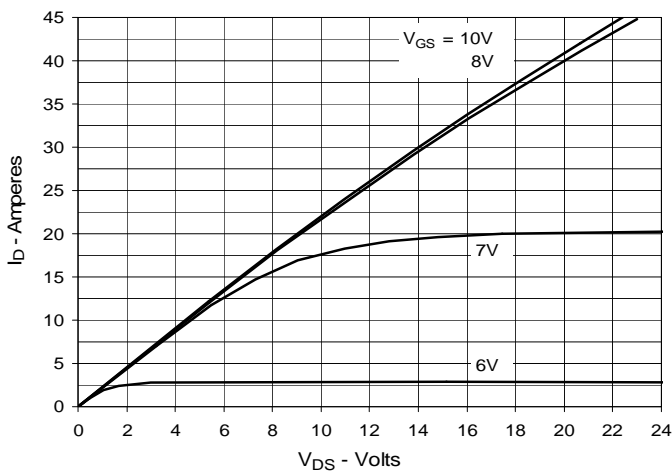
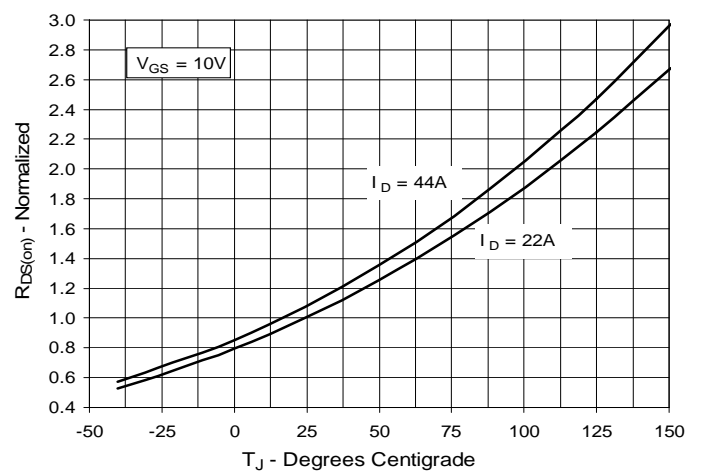
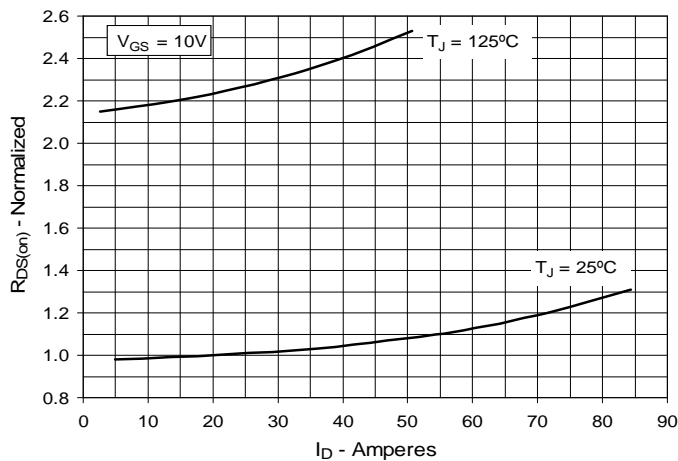
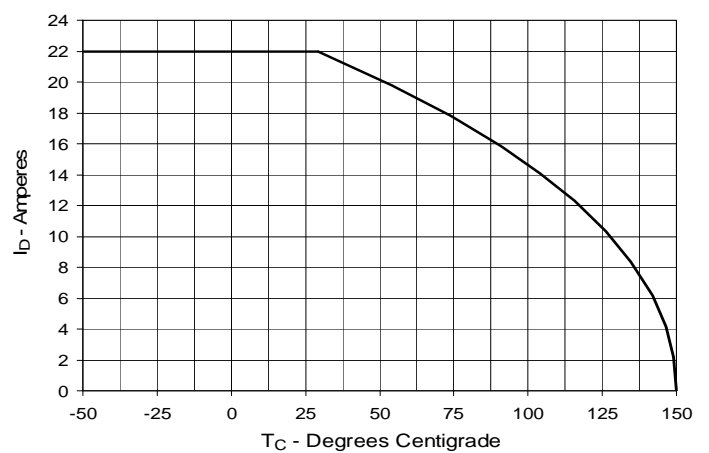
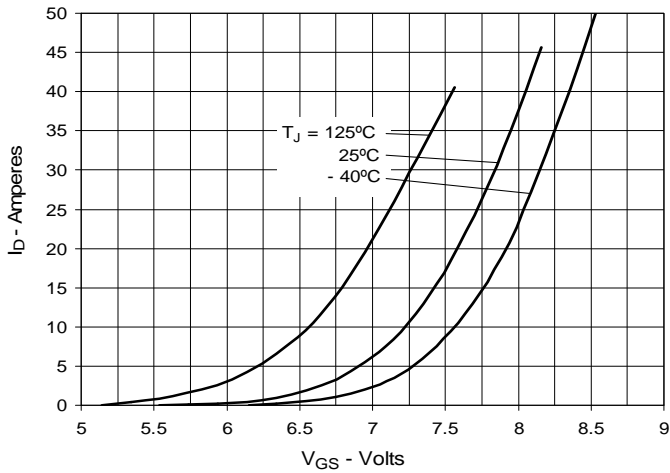
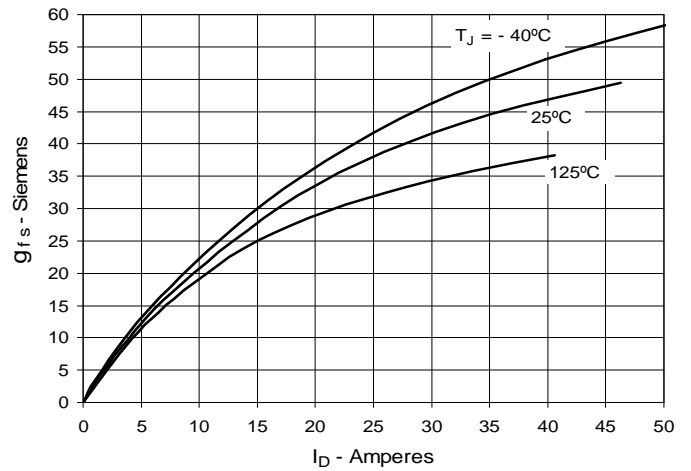
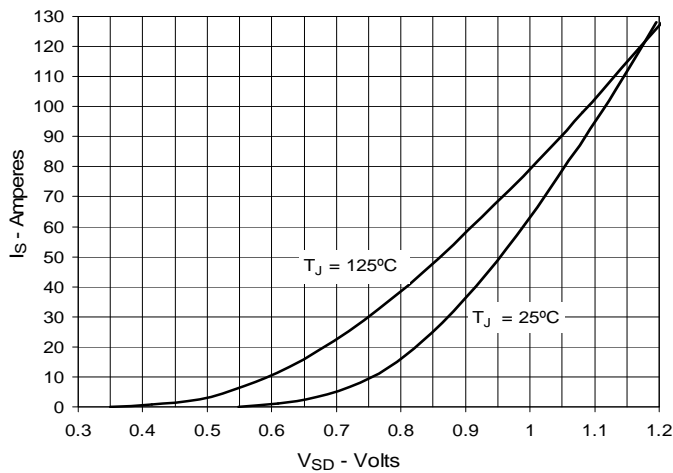
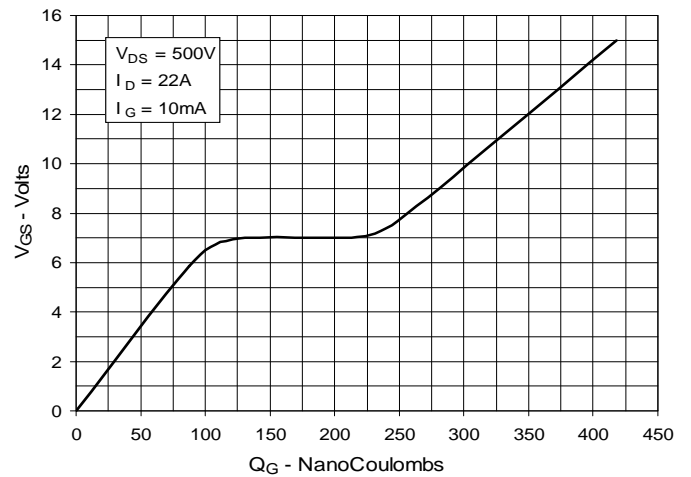
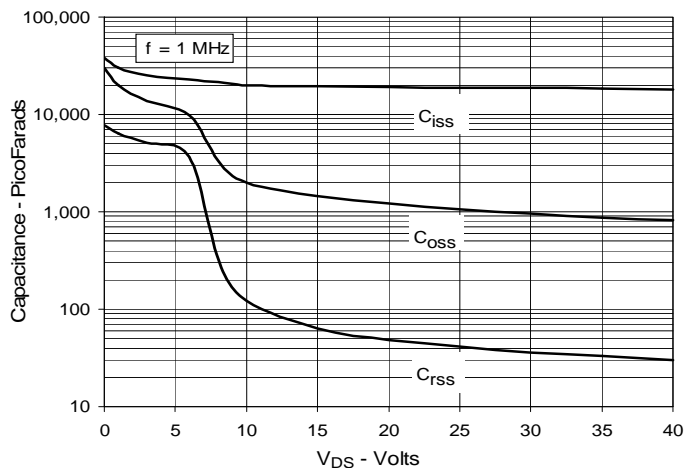
Fig. 6. Maximum Drain Current vs. Case Temperature

Fig. 7. Input Admittance

Fig. 8. Transconductance

Fig. 9. Forward Voltage Drop of Intrinsic Diode

Fig. 10. Gate Charge

Fig. 11. Capacitance

Fig. 12. Maximum Transient Thermal Impedance
