

Polar™ HiPerFET™
Power MOSFET

IXFT88N30P
IXFH88N30P
IXFK88N30P

$V_{DSS} = 300V$
 $I_{D25} = 88A$
 $R_{DS(on)} \leq 40m\Omega$
 $t_{rr} \leq 200ns$

N-Channel Enhancement Mode
Avalanche Rated
Fast Intrinsic Diode

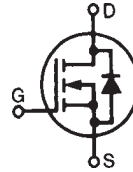

| Symbol | Test Conditions | Maximum Ratings | |
|---------------|--|-----------------|------------|
| V_{DSS} | $T_J = 25^\circ C$ to $150^\circ C$ | 300 | V |
| V_{DGR} | $T_J = 25^\circ C$ to $150^\circ C$, $R_{GS} = 1M\Omega$ | 300 | V |
| V_{GSS} | Continuous | ± 20 | V |
| V_{GSM} | Transient | ± 30 | V |
| I_{D25} | $T_C = 25^\circ C$ | 88 | A |
| $I_{L(RMS)}$ | External Lead Current Limit | 75 | A |
| I_{DM} | $T_C = 25^\circ C$, Pulse Width Limited by T_{JM} | 220 | A |
| I_A | $T_C = 25^\circ C$ | 60 | A |
| E_{AS} | $T_C = 25^\circ C$ | 2 | J |
| dV/dt | $I_S \leq I_{DM}$, $V_{DD} \leq V_{DSS}$, $T_J \leq 150^\circ C$ | 10 | V/ns |
| P_D | $T_C = 25^\circ C$ | 600 | W |
| T_J | | -55 to +150 | $^\circ C$ |
| T_{JM} | | +150 | $^\circ C$ |
| T_{stg} | | -55 to +150 | $^\circ C$ |
| T_L | 1.6mm (0.063in) from Case for 10s | 300 | $^\circ C$ |
| T_{SOLD} | Plastic Body for 10s | 260 | $^\circ C$ |
| M_d | Mounting Torque (TO-247&TO-264) | 1.13/10 | Nm/lb.in. |
| Weight | TO-268 | 4 | g |
| | TO-247 | 6 | g |
| | TO-264 | 10 | g |

| Symbol | Test Conditions ($T_J = 25^\circ C$, Unless Otherwise Specified) | Characteristic Values | | |
|--------------|---|-----------------------|------|---------------|
| | | Min. | Typ. | Max. |
| BV_{DSS} | $V_{GS} = 0V$, $I_D = 250\mu A$ | 300 | | V |
| $V_{GS(th)}$ | $V_{DS} = V_{GS}$, $I_D = 4mA$ | 2.5 | | 5.0 V |
| I_{GSS} | $V_{GS} = \pm 20V$, $V_{DS} = 0V$ | | | ± 100 nA |
| I_{DSS} | $V_{DS} = V_{DSS}$, $V_{GS} = 0V$ $T_J = 125^\circ C$ | | | 25 μA |
| | | | | 250 μA |
| $R_{DS(on)}$ | $V_{GS} = 10V$, $I_D = 0.5 \cdot I_{D25}$, Note 1 | | | 40 m Ω |

TO-268 (IXFT)

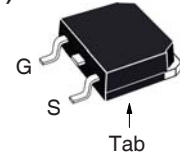

TO-247(IXFH)

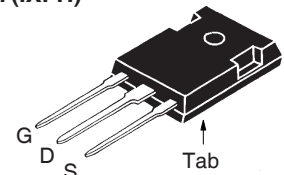

TO-264 (IXFK)

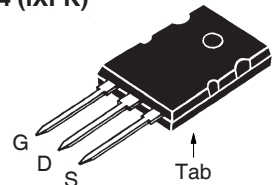

G = Gate D = Drain
S = Source Tab = Drain

Features

- International Standard Packages
- Fast Intrinsic Diode
- Avalanche Rated
- Low $R_{DS(ON)}$ and Q_G
- Low Package Inductance

Advantages

- High Power Density
- Easy to Mount
- Space Savings

Applications

- DC-DC Converters
- Battery Chargers
- Switch-Mode and Resonant-Mode Power Supplies
- DC Choppers
- AC and DC Motor Drives
- Uninterrupted Power Supplies
- High Speed Power Switching Applications

| Symbol | Test Conditions ($T_J = 25^\circ\text{C}$, Unless Otherwise Specified) | Characteristic Values | | |
|--------------|---|-----------------------|------|-------------------------|
| | | Min. | Typ. | Max. |
| g_{fs} | $V_{DS} = 10\text{V}, I_D = 0.5 \cdot I_{D25}$, Note 1 | 40 | 60 | S |
| C_{iss} | $V_{GS} = 0\text{V}, V_{DS} = 25\text{V}, f = 1\text{MHz}$ | | 6300 | pF |
| C_{oss} | | | 950 | pF |
| C_{rss} | | | 190 | pF |
| $t_{d(on)}$ | Resistive Switching Times $V_{GS} = 10\text{V}, V_{DS} = 0.5 \cdot V_{DSS}, I_D = 60\text{A}$ $R_G = 3.3\Omega$ (External) | | 25 | ns |
| t_r | | | 24 | ns |
| $t_{d(off)}$ | | | 96 | ns |
| t_f | | | 25 | ns |
| $Q_{g(on)}$ | $V_{GS} = 10\text{V}, V_{DS} = 0.5 \cdot V_{DSS}, I_D = 0.5 \cdot I_{D25}$ | | 180 | nC |
| Q_{gs} | | | 44 | nC |
| Q_{gd} | | | 90 | nC |
| R_{thJC} | | | | 0.21 $^\circ\text{C/W}$ |
| R_{thCS} | TO-247 | | 0.21 | $^\circ\text{C/W}$ |
| | TO-264 | | 0.15 | $^\circ\text{C/W}$ |

Source-Drain Diode

| Symbol | Test Conditions ($T_J = 25^\circ\text{C}$, Unless Otherwise Specified) | Characteristic Values | | |
|----------|---|-----------------------|------|---------------|
| | | Min. | Typ. | Max. |
| I_S | $V_{GS} = 0\text{V}$ | | | 88 A |
| I_{SM} | Repetitive, Pulse Width Limited by T_{JM} | | | 220 A |
| V_{SD} | $I_F = I_S, V_{GS} = 0\text{V}$, Note 1 | | | 1.5 V |
| t_{rr} | $I_F = 25\text{A}, -di/dt = 100\text{A}/\mu\text{s}$, $V_R = 100\text{V}, V_{GS} = 0\text{V}$ | | 100 | 200 ns |
| Q_{RM} | | | 0.6 | μC |

Note 1. Pulse test, $t \leq 300\mu\text{s}$, duty cycle, $d \leq 2\%$.

TO-264 (IXFK) Outline

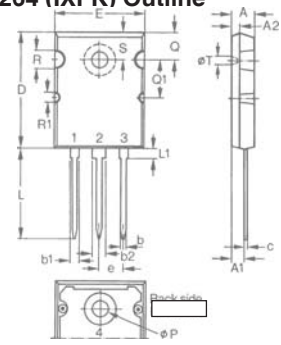

| Dim. | Millimeter | | Inches | |
|------|------------|-------|----------|-------|
| | Min. | Max. | Min. | Max. |
| A | 4.82 | 5.13 | .190 | .202 |
| A1 | 2.54 | 2.89 | .100 | .114 |
| A2 | 2.00 | 2.10 | .079 | .083 |
| b | 1.12 | 1.42 | .044 | .056 |
| b1 | 2.39 | 2.69 | .094 | .106 |
| b2 | 2.90 | 3.09 | .114 | .122 |
| c | 0.53 | 0.83 | .021 | .033 |
| D | 25.91 | 26.16 | 1.020 | 1.030 |
| E | 19.81 | 19.96 | .780 | .786 |
| e | 5.46 BSC | | .215 BSC | |
| J | 0.00 | 0.25 | .000 | .010 |
| K | 0.00 | 0.25 | .000 | .010 |
| L | 20.32 | 20.83 | .800 | .820 |
| L1 | 2.29 | 2.59 | .090 | .102 |
| P | 3.17 | 3.66 | .125 | .144 |
| Q | 6.07 | 6.27 | .239 | .247 |
| Q1 | 8.38 | 8.69 | .330 | .342 |
| R | 3.81 | 4.32 | .150 | .170 |
| R1 | 1.78 | 2.29 | .070 | .090 |
| S | 6.04 | 6.30 | .238 | .248 |
| T | 1.57 | 1.83 | .062 | .072 |

TO-247 (IXFH) Outline

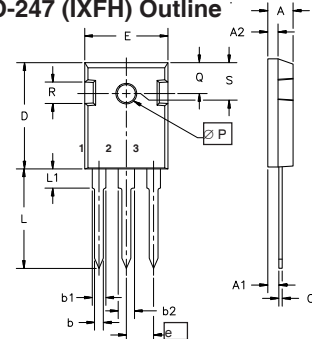

Terminals: 1 - Gate 2 - Drain
3 - Source Tab - Drain

| Dim. | Millimeter | | Inches | |
|----------------|------------|----------|--------|---------|
| | Min. | Max. | Min. | Max. |
| A | 4.7 | 5.3 | .185 | .209 |
| A ₁ | 2.2 | 2.54 | .087 | .102 |
| A ₂ | 2.2 | 2.6 | .059 | .098 |
| b | 1.0 | 1.4 | .040 | .055 |
| b ₁ | 1.65 | 2.13 | .065 | .084 |
| b ₂ | 2.87 | 3.12 | .113 | .123 |
| C | .4 | .8 | .016 | .031 |
| D | 20.80 | 21.46 | .819 | .845 |
| E | 15.75 | 16.26 | .610 | .640 |
| e | 5.20 | 5.72 | 0.205 | 0.225 |
| L | 19.81 | 20.32 | .780 | .800 |
| L1 | | 4.50 | | .177 |
| ∅P | 3.55 | 3.65 | .140 | .144 |
| Q | 5.89 | 6.40 | 0.232 | 0.252 |
| R | 4.32 | 5.49 | .170 | .216 |
| S | | 6.15 BSC | | 242 BSC |

TO-268 (IXFT) Outline

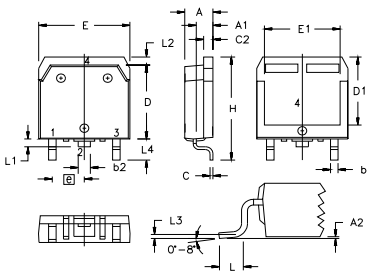

| SYM | INCHES | | MILLIMETERS | |
|-----|----------|------|-------------|-------|
| | MIN | MAX | MIN | MAX |
| A | .193 | .201 | 4.90 | 5.10 |
| A1 | .106 | .114 | 2.70 | 2.90 |
| A2 | .001 | .010 | 0.02 | 0.25 |
| b | .045 | .057 | 1.15 | 1.45 |
| b2 | .075 | .083 | 1.90 | 2.10 |
| C | .016 | .026 | 0.40 | 0.65 |
| C2 | .057 | .063 | 1.45 | 1.60 |
| D | .543 | .551 | 13.80 | 14.00 |
| D1 | .488 | .500 | 12.40 | 12.70 |
| E | .624 | .632 | 15.85 | 16.05 |
| E1 | .524 | .535 | 13.30 | 13.60 |
| e | .215 BSC | | 5.45 BSC | |
| H | .736 | .752 | 18.70 | 19.10 |
| L | .094 | .106 | 2.40 | 2.70 |
| L1 | .047 | .055 | 1.20 | 1.40 |
| L2 | .039 | .045 | 1.00 | 1.15 |
| L3 | .010 BSC | | 0.25 BSC | |
| L4 | .150 | .161 | 3.80 | 4.10 |

IXYS Reserves the Right to Change Limits, Test Conditions, and Dimensions.

IXYS MOSFETs and IGBTs are covered 4,835,592 4,931,844 5,049,961 5,237,481 6,162,665 6,404,065 B1 6,683,344 6,727,585 7,005,734 B2 7,157,338B2
by one or more of the following U.S. patents: 4,850,072 5,017,508 5,063,307 5,381,025 6,259,123 B1 6,534,343 6,710,405 B2 6,759,692 7,063,975 B2
4,881,106 5,034,796 5,187,117 5,486,715 6,306,728 B1 6,583,505 6,710,463 6,771,478 B2 7,071,537

Fig. 1. Output Characteristics @ $T_J = 25^\circ\text{C}$

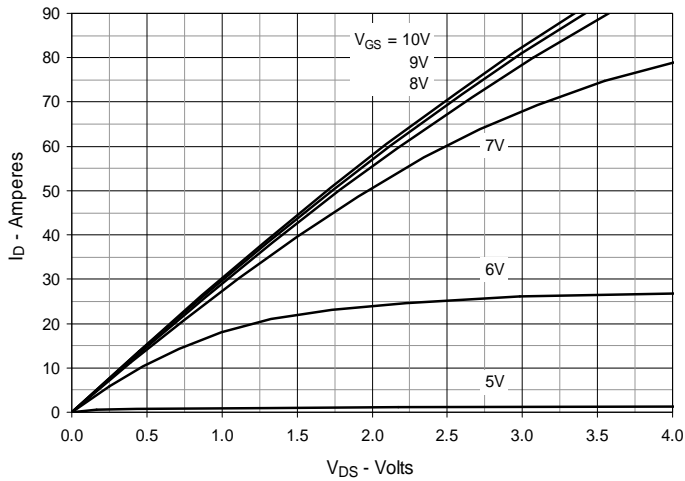

Fig. 2. Extended Output Characteristics @ $T_J = 25^\circ\text{C}$

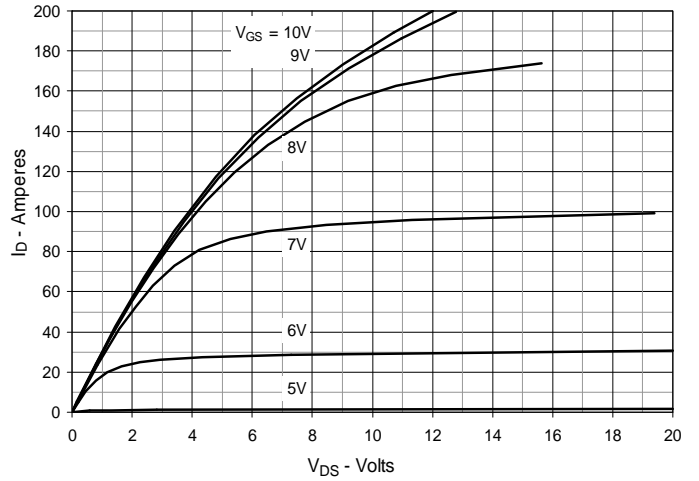

Fig. 3. Output Characteristics @ $T_J = 125^\circ\text{C}$

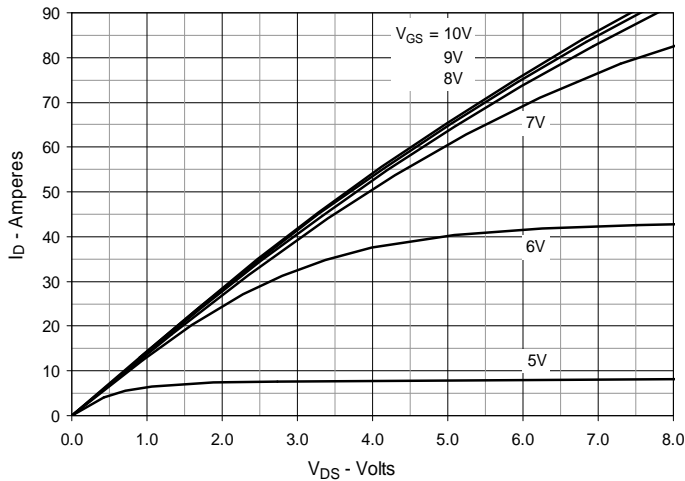

Fig. 4. $R_{DS(on)}$ Normalized to $I_D = 44\text{A}$ Value vs. Junction Temperature

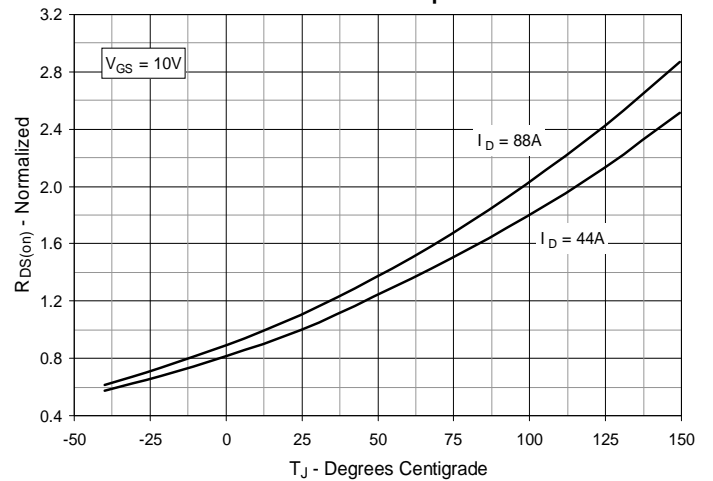

Fig. 5. $R_{DS(on)}$ Normalized to $I_D = 44\text{A}$ Value vs. Drain Current

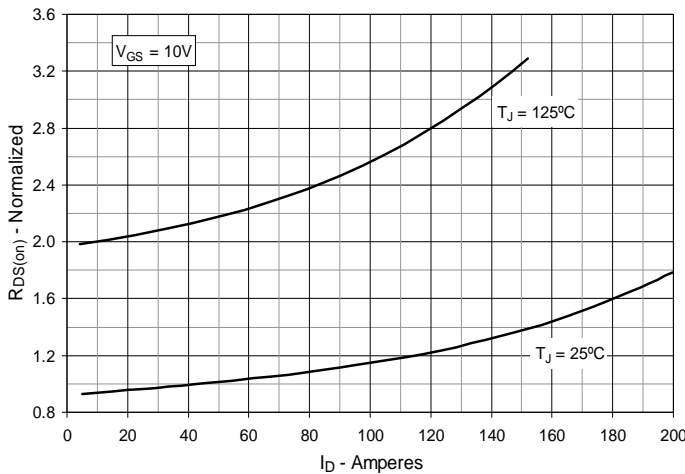

Fig. 6. Maximum Drain Current vs. Case Temperature

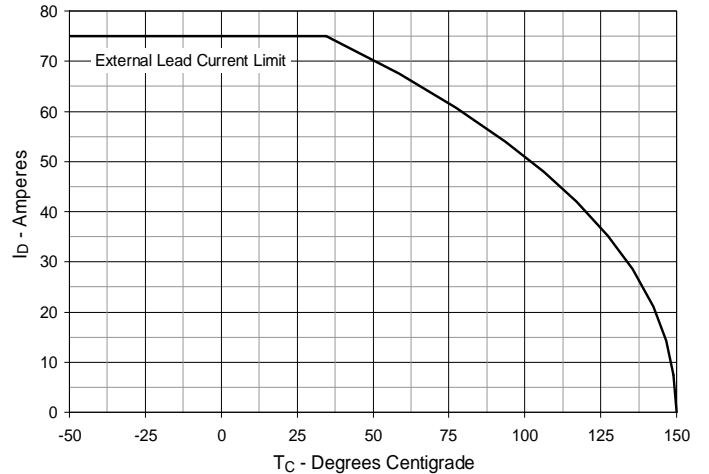

Fig. 7. Input Admittance

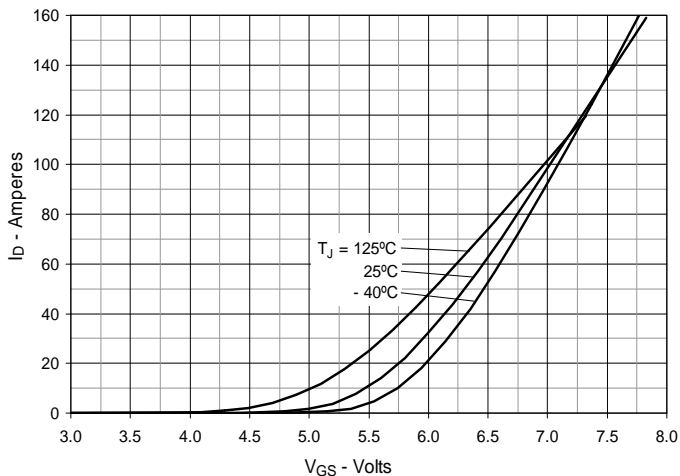

Fig. 8. Transconductance

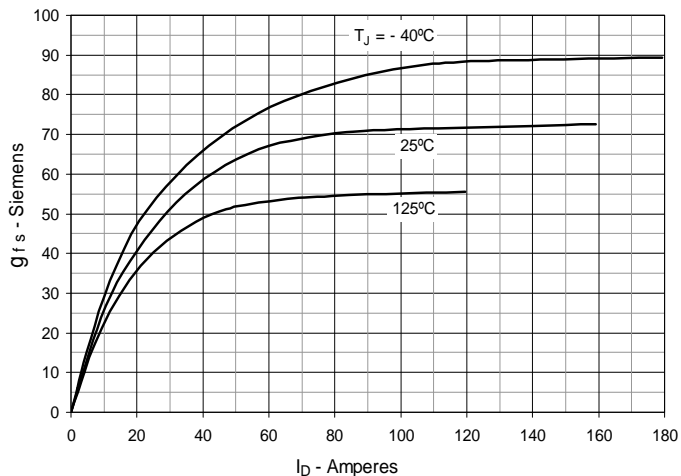

Fig. 9. Forward Voltage Drop of Intrinsic Diode

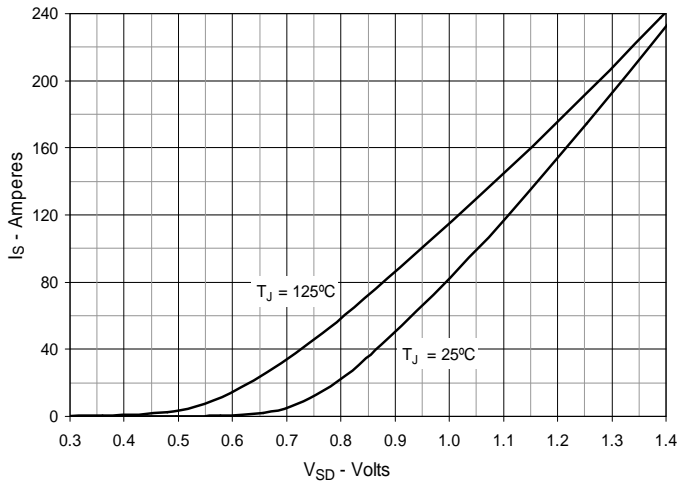

Fig. 10. Gate Charge

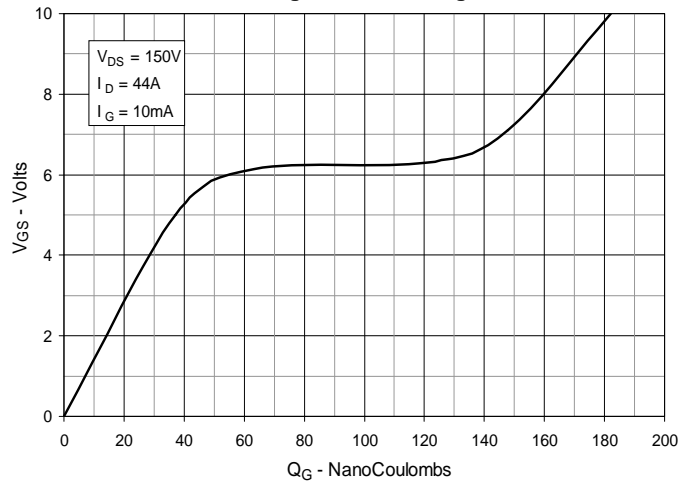

Fig. 11. Capacitance

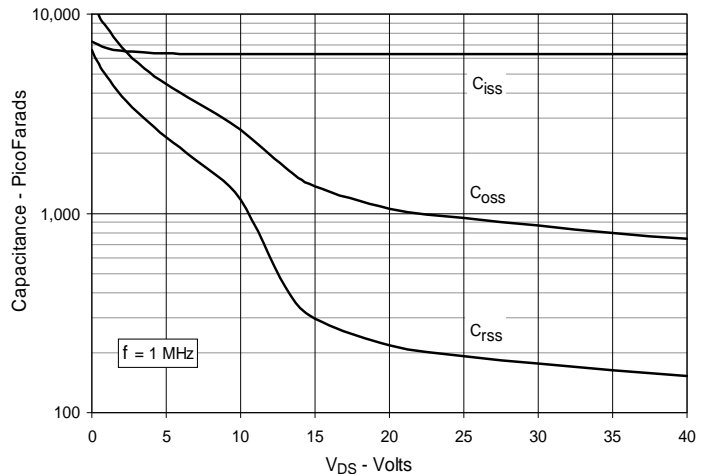

Fig. 12. Forward-Bias Safe Operating Area

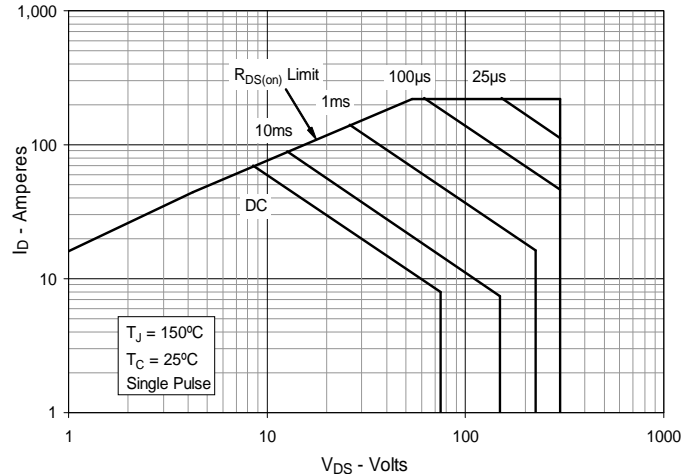
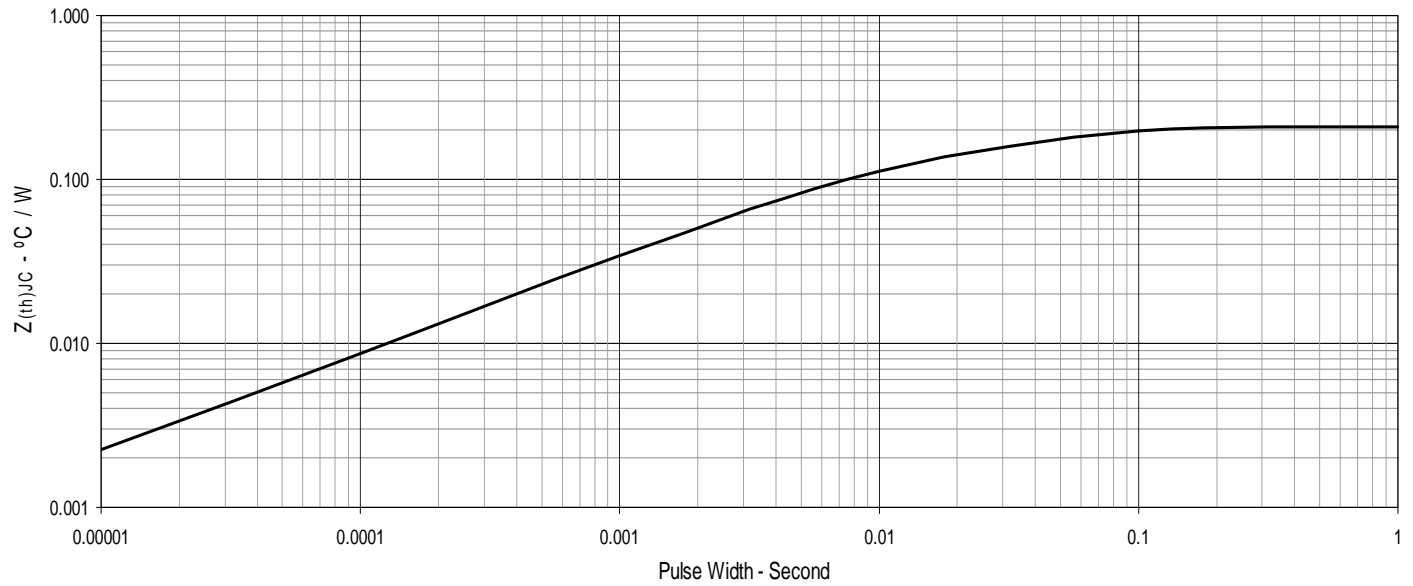

Fig. 13. Maximum Transient Thermal Impedance



www.DataSheet4U.net