

# GenX3™ 300V IGBT IXGA42N30C3

# IXGH42N30C3

# IXGP42N30C3

High Speed PT IGBTs for  
50-150kHz switching

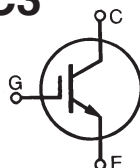

$V_{CES} = 300V$   
 $I_{C110} = 42A$   
 $V_{CE(sat)} \leq 1.85V$   
 $t_{fi\ typ} = 65ns$

Symbol	Test Conditions	Maximum Ratings	
$V_{CES}$	$T_J = 25^\circ C$ to $150^\circ C$	300	V
$V_{CGR}$	$T_J = 25^\circ C$ to $150^\circ C$ , $R_{GE} = 1M\Omega$	300	V
$V_{GES}$	Continuous	$\pm 20$	V
$V_{GEM}$	Transient	$\pm 30$	V
$I_{C110}$	$T_C = 110^\circ C$ (chip capability)	42	A
$I_{CM}$	$T_C = 25^\circ C$ , 1ms	250	A
$I_A$	$T_C = 25^\circ C$	42	A
$E_{AS}$	$T_C = 25^\circ C$	250	mJ
<b>SSOA</b> <b>(RBSOA)</b>	$V_{GE} = 15V$ , $T_{VJ} = 125^\circ C$ , $R_G = 10\Omega$ Clamped inductive load @ $\leq 300V$	$I_{CM} = 84$	A
$P_C$	$T_C = 25^\circ C$	223	W
$T_J$		-55 ... +150	$^\circ C$
$T_{JM}$		150	$^\circ C$
$T_{stg}$		-55 ... +150	$^\circ C$
$T_L$	Maximum lead temperature for soldering	300	$^\circ C$
$T_{SOLD}$	1.6mm (0.062 in.) from case for 10s	260	$^\circ C$
$M_d$	Mounting torque (TO-247)(TO-220)	1.13/10	Nm/lb.in.
<b>Weight</b>	TO-263	2.5	g
	TO-247	6.0	g
	TO-220	3.0	g

TO-263 (IXGA)



TO-247 (IXGH)

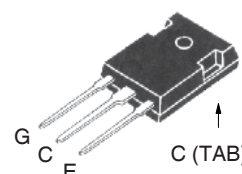

TO-220 (IXGP)

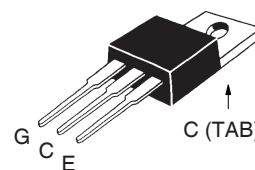

G = Gate                      C = Collector  
 E = Emitter                 TAB = Collector

## Features

- Optimized for low switching losses
- Square RBSOA
- High current handling capability
- International standard packages

## Advantages

- High power density
- Low gate drive requirement

## Applications

- High Frequency Power Inverters
- UPS
- Motor Drives
- SMPS
- PFC Circuits
- Battery Chargers
- Welding Machines
- Lamp Ballasts

Symbol	Test Conditions	Characteristic Values		
		Min.	Typ.	Max.
$BV_{CES}$	$I_C = 250\mu A$ , $V_{GE} = 0V$	300		V
$V_{GE(th)}$	$I_C = 250\mu A$ , $V_{CE} = V_{GE}$	2.5		5.0 V
$I_{CES}$	$V_{CE} = V_{CES}$			25 $\mu A$
	$V_{GE} = 0V$ $T_J = 125^\circ C$			500 $\mu A$
$I_{GES}$	$V_{CE} = 0V$ , $V_{GE} = \pm 20V$			$\pm 100$ nA
$V_{CE(sat)}$	$I_C = 42A$ , $V_{GE} = 15V$ , Note1		1.54	1.85 V
	$T_J = 125^\circ C$		1.54	V

Symbol	Test Conditions	Characteristic Values		
		Min.	Typ.	Max.
$g_{fs}$	$I_C = 0.5 \cdot I_{C110}, V_{CE} = 10V, \text{Note 1}$	20	33	S
$C_{ies}$	$V_{CE} = 25V, V_{GE} = 0V, f = 1MHz$		2140	pF
$C_{oes}$			218	pF
$C_{res}$			60	pF
$Q_g$	$I_C = I_{C110}, V_{GE} = 15V, V_{CE} = 0.5 \cdot V_{CES}$		76	nC
$Q_{ge}$			15	nC
$Q_{gc}$			26	nC
$t_{d(on)}$	<b>Inductive Load, <math>T_J = 25^\circ C</math></b> $I_C = 0.5 \cdot I_{C110}, V_{GE} = 15V$ $V_{CE} = 200V, R_G = 10\Omega$		21	ns
$t_{ri}$			23	ns
$E_{on}$			0.12	mJ
$t_{d(off)}$			113	170 ns
$t_{fi}$			65	120 ns
$E_{off}$			0.15	0.28 mJ
$t_{d(on)}$	<b>Inductive Load, <math>T_J = 125^\circ C</math></b> $I_C = 0.5 \cdot I_{C110}, V_{GE} = 15V$ $V_{CE} = 200V, R_G = 10\Omega$		21	ns
$t_{ri}$			22	ns
$E_{on}$			0.21	mJ
$t_{d(off)}$			127	ns
$t_{fi}$			102	ns
$E_{off}$			0.20	mJ
$R_{thJC}$			0.56	$^\circ C/W$
$R_{thCK}$	TO-220	0.50		$^\circ C/W$
	TO-247	0.25		$^\circ C/W$

**TO-247 AD Outline**

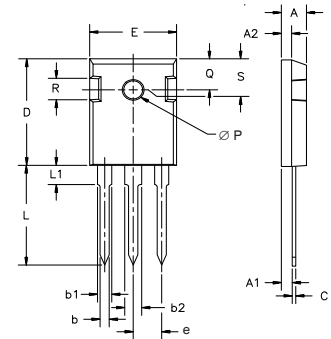

Dim.	Millimeter		Inches	
	Min.	Max.	Min.	Max.
A	4.7	5.3	.185	.209
A <sub>1</sub>	2.2	2.54	.087	.102
A <sub>2</sub>	2.2	2.6	.059	.098
b	1.0	1.4	.040	.055
b <sub>1</sub>	1.65	2.13	.065	.084
b <sub>2</sub>	2.87	3.12	.113	.123
C	.4	.8	.016	.031
D	20.80	21.46	.819	.845
E	15.75	16.26	.610	.640
e	5.20	5.72	0.205	0.225
L	19.81	20.32	.780	.800
L1		4.50		.177
∅P	3.55	3.65	.140	.144
Q	5.89	6.40	0.232	0.252
R	4.32	5.49	.170	.216
S	6.15	BSC	242	BSC

Note1. Pulse test,  $t \leq 300\mu s$ ; duty cycle,  $d \leq 2\%$ .

**TO-220 (IXGP) Outline**

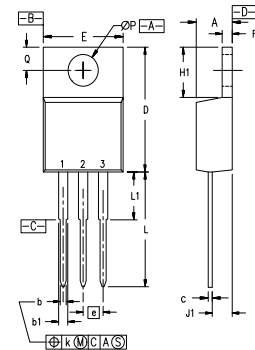

Pins: 1 - Gate 2 - Drain

SYM	INCHES		MILLIMETERS	
	MIN	MAX	MIN	MAX
A	.170	.190	4.32	4.83
b	.025	.040	0.64	1.02
b <sub>1</sub>	.045	.065	1.15	1.65
c	.014	.022	0.35	0.56
D	.580	.630	14.73	16.00
E	.390	.420	9.91	10.66
e	.100	BSC	2.54	BSC
F	.045	.055	1.14	1.40
H1	.230	.270	5.85	6.85
J1	.090	.110	2.29	2.79
k	0	.015	0	0.38
L	.500	.550	12.70	13.97
L1	.110	.230	2.79	5.84
∅P	.139	.161	3.53	4.08
Q	.100	.125	2.54	3.18

**TO-263 (IXGA) Outline**

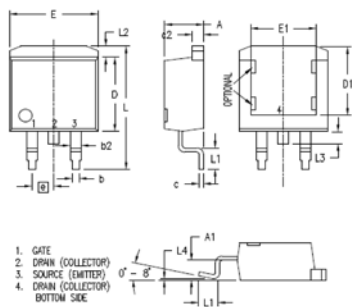

SYM	INCHES		MILLIMETERS	
	MIN	MAX	MIN	MAX
A	.160	.190	4.06	4.83
A <sub>1</sub>	.080	.110	2.03	2.79
b	.020	.039	0.51	0.99
b <sub>2</sub>	.045	.055	1.14	1.40
c	.016	.029	0.40	0.74
c <sub>2</sub>	.045	.055	1.14	1.40
D	.340	.380	8.64	9.65
D <sub>1</sub>	.315	.350	8.00	8.89
E	.380	.410	9.65	10.41
E <sub>1</sub>	.245	.320	6.22	8.13
e	.100	BSC	2.54	BSC
L	.575	.625	14.61	15.88
L <sub>1</sub>	.090	.110	2.29	2.79
L <sub>2</sub>	.040	.055	1.02	1.40
L <sub>3</sub>	.050	.070	1.27	1.78
L <sub>4</sub>	0	.005	0	0.13

IXYS reserves the right to change limits, test conditions, and dimensions.

IXYS MOSFETs and IGBTs are covered 4,835,592 4,931,844 5,049,961 5,237,481 6,162,665 6,404,065 B1 6,683,344 6,727,585 7,005,734 B2 7,157,338B2  
by one or more of the following U.S. patents: 4,850,072 5,017,508 5,063,307 5,381,025 6,259,123 B1 6,534,343 6,710,405 B2 6,759,692 7,063,975 B2  
4,881,106 5,034,796 5,187,117 5,486,715 6,306,728 B1 6,583,505 6,710,463 6,771,478 B2 7,071,537

**Fig. 1. Output Characteristics @ 25°C**

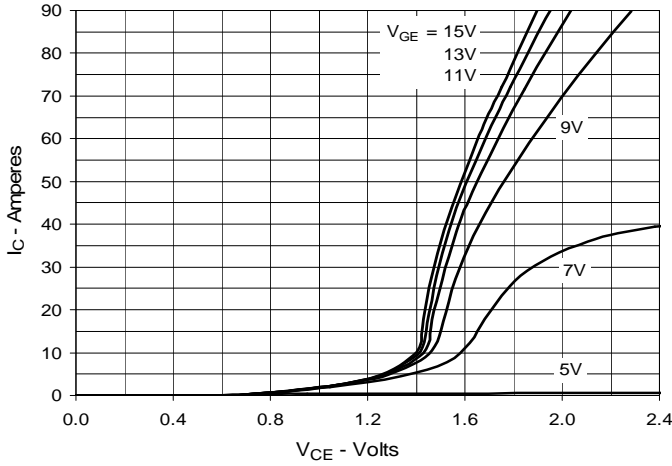

**Fig. 2. Extended Output Characteristics @ 25°C**

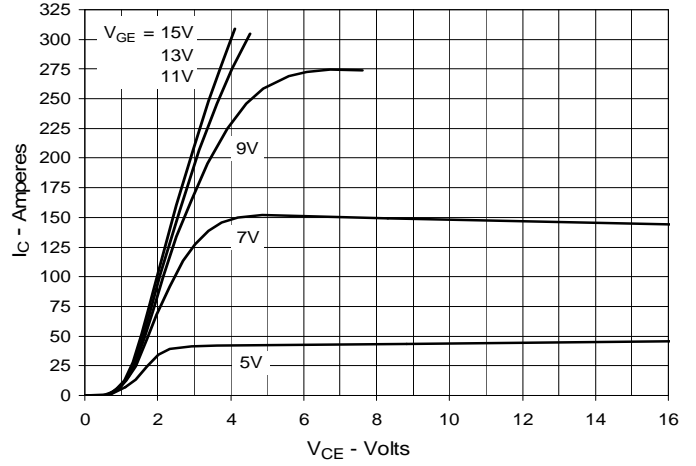

**Fig. 3. Output Characteristics @ 125°C**

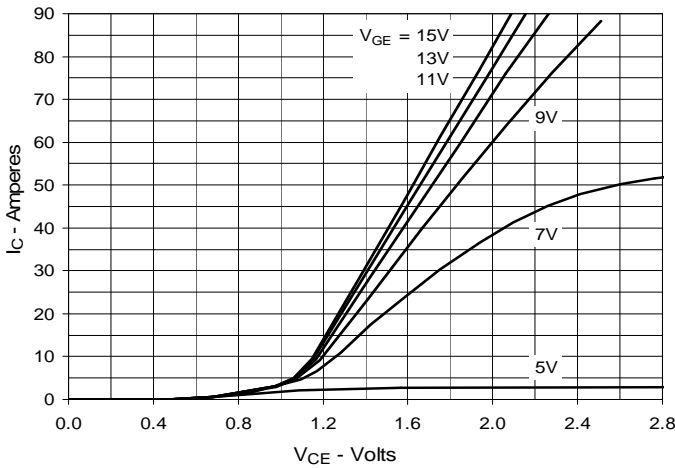

**Fig. 4. Dependence of VCE(sat) on Junction Temperature**

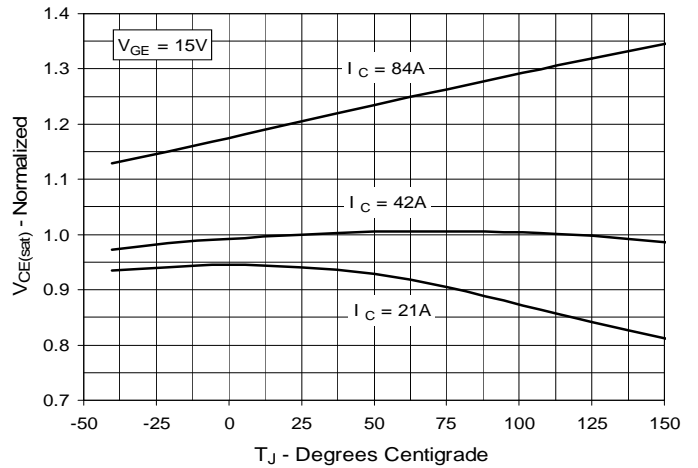

**Fig. 5. Collector-to-Emitter Voltage vs. Gate-to-Emitter Voltage**

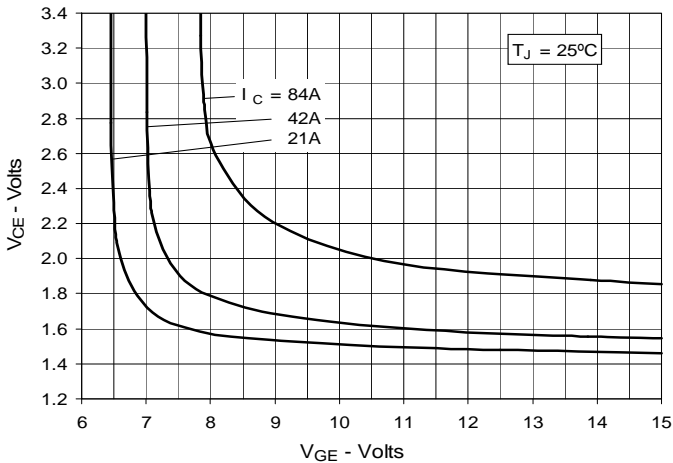

**Fig. 6. Input Admittance**

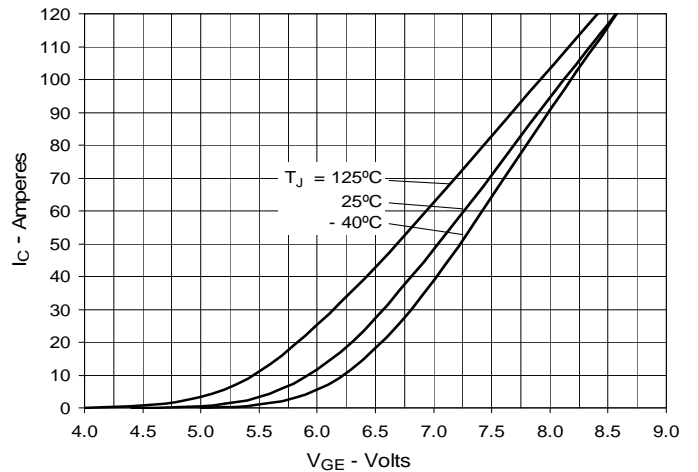

**Fig. 7. Transconductance**

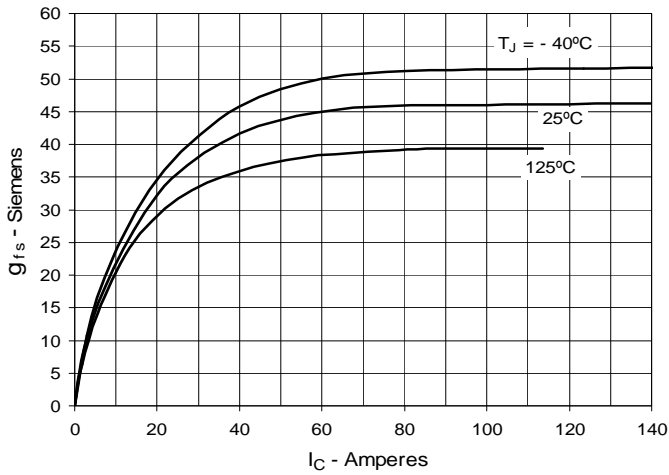

**Fig. 8. Gate Charge**

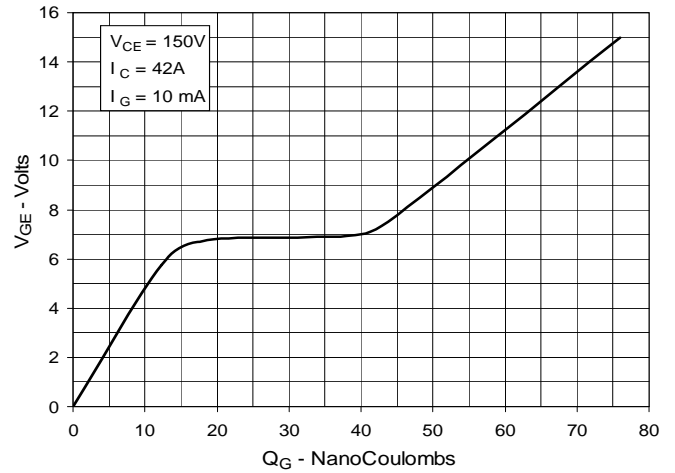

**Fig. 9. Capacitance**

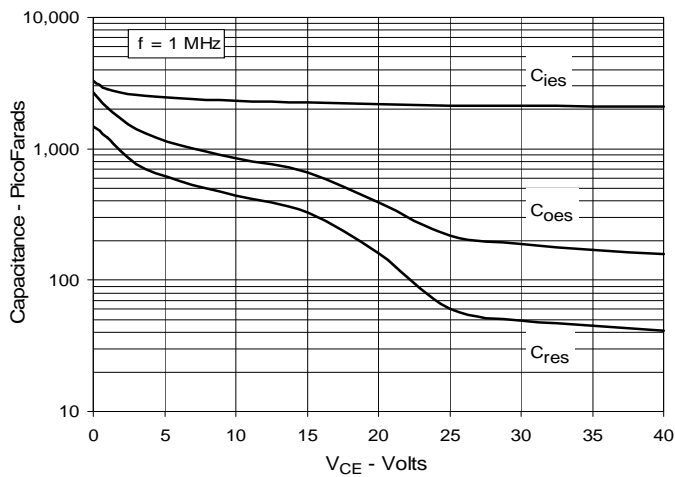

**Fig. 10. Reverse-Bias Safe Operating Area**

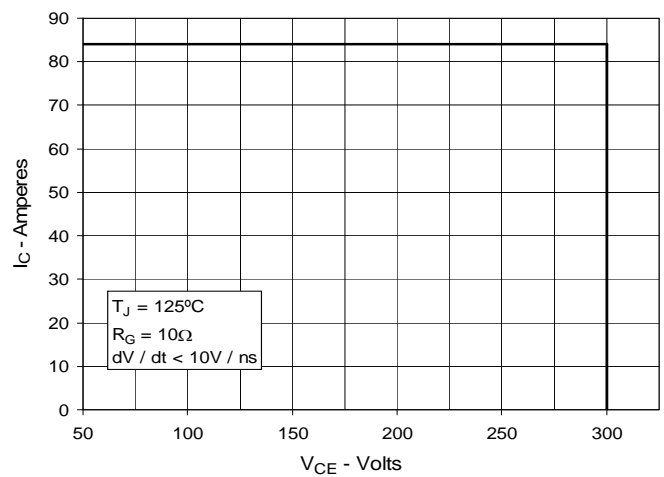

**Fig. 11. Maximum Transient Thermal Impedance**

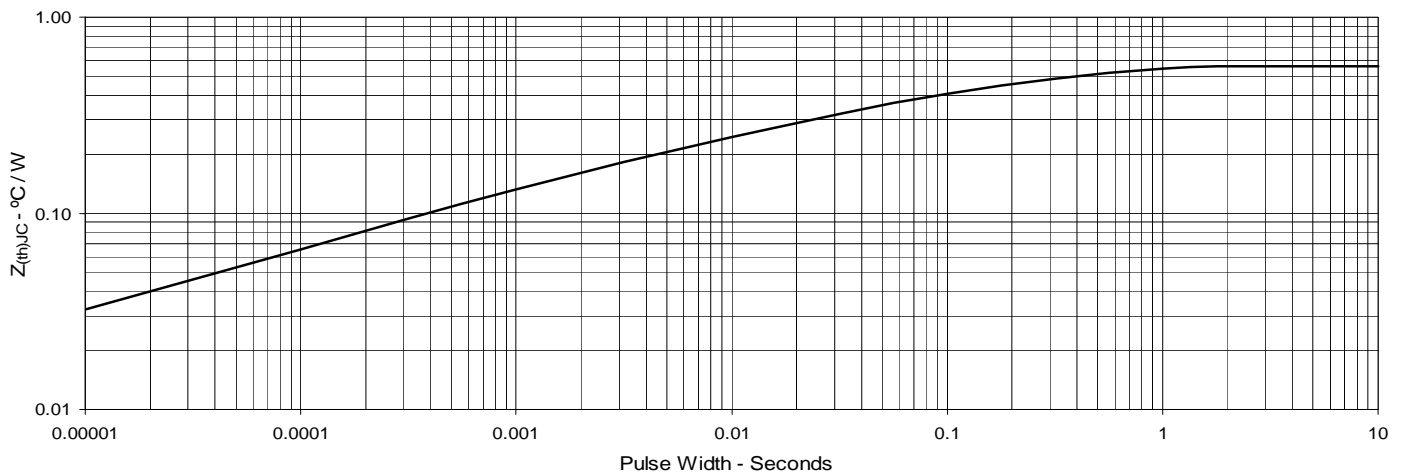

**Fig. 12. Inductive Switching Energy Loss vs. Gate Resistance**

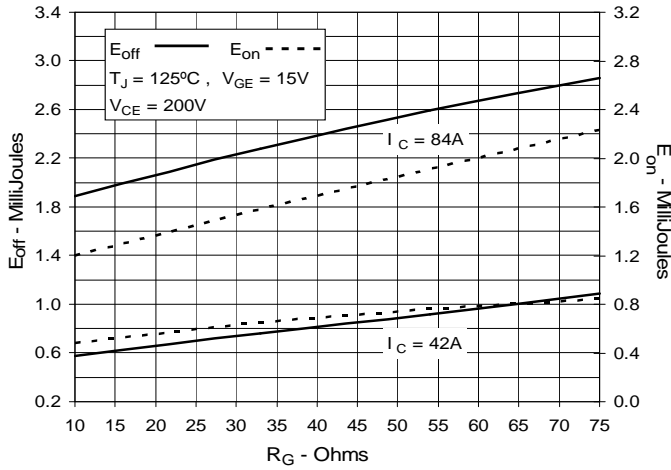

**Fig. 13. Inductive Switching Energy Loss vs. Collector Current**

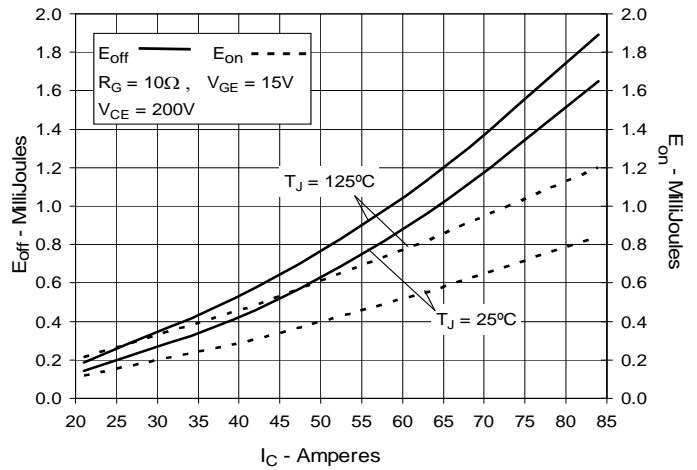

**Fig. 14. Inductive Switching Energy Loss vs. Junction Temperature**

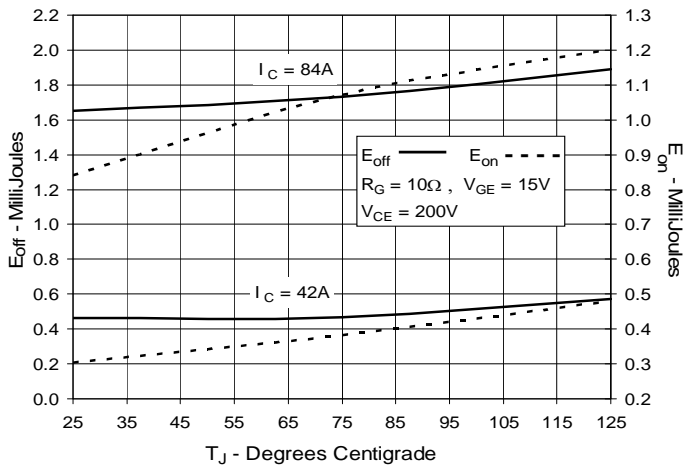

**Fig. 15. Inductive Turn-off Switching Times vs. Gate Resistance**

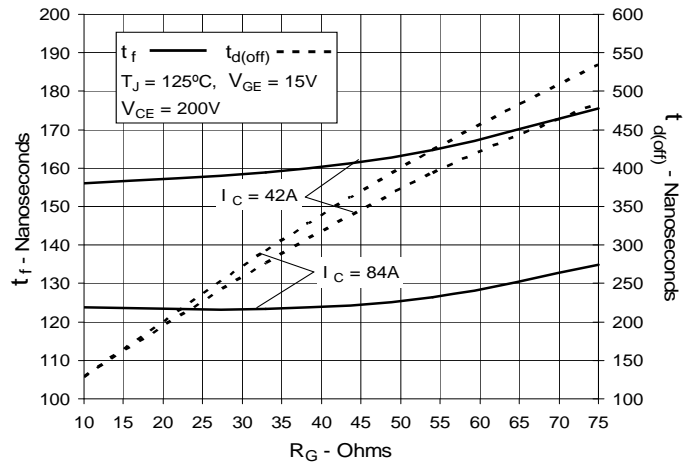

**Fig. 16. Inductive Turn-off Switching Times vs. Collector Current**

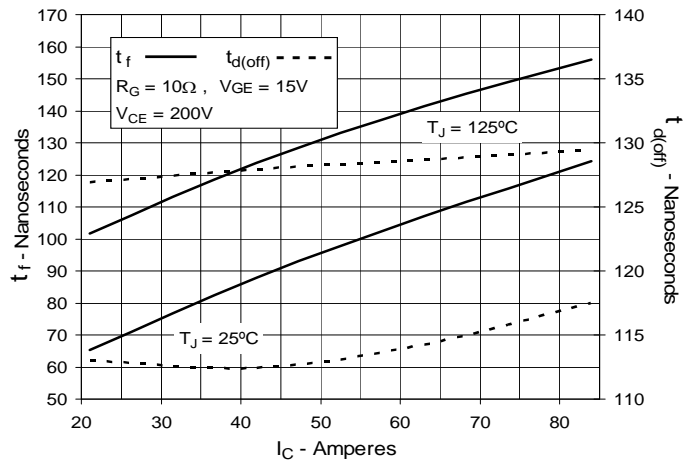

**Fig. 17. Inductive Turn-off Switching Times vs. Junction Temperature**

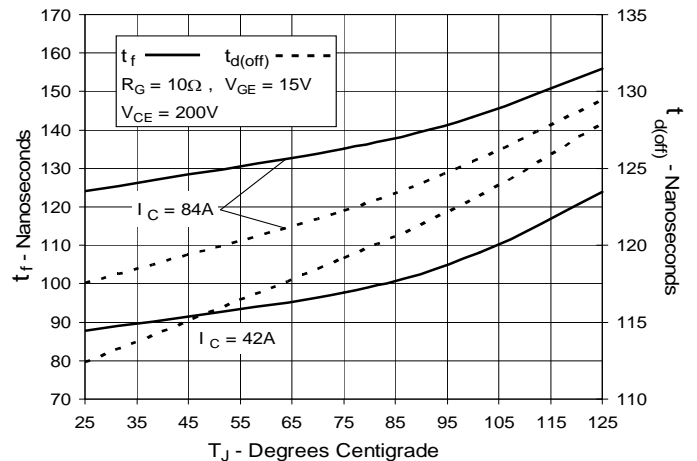

**Fig. 18. Inductive Turn-on Switching Times vs. Gate Resistance**

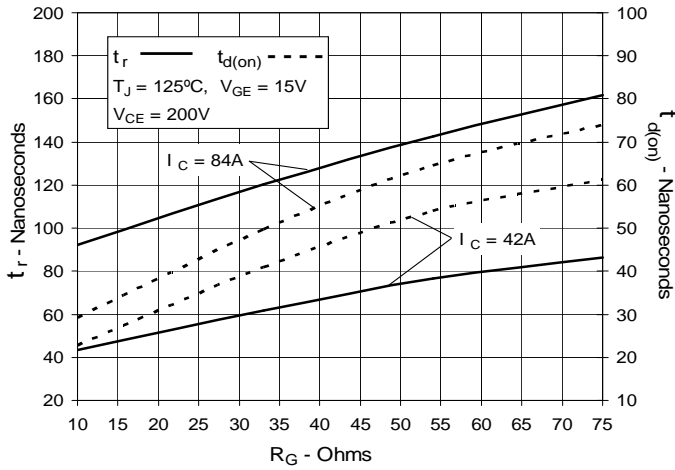

**Fig. 19. Inductive Turn-on Switching Times vs. Collector Current**

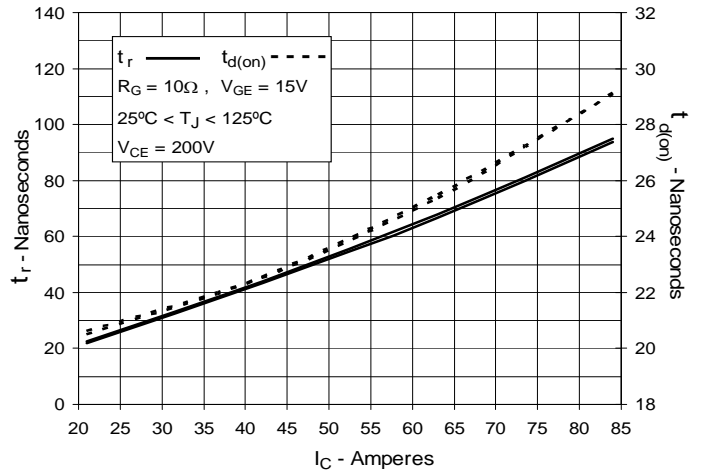

**Fig. 20. Inductive Turn-on Switching Times vs. Junction Temperature**

