

HiPerFAST™ IGBT with Diode

Combi Pack

IXGH 30N60BU1
IXGT 30N60BU1

$V_{CES} = 600\text{ V}$
 $I_{C25} = 60\text{ A}$
 $V_{CE(sat)} = 1.8\text{ V}$
 $t_{fi} = 100\text{ ns}$

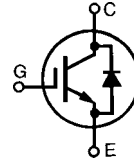

www.DataSheet4U.com

| Symbol | Test Conditions | Maximum Ratings | |
|---|--|----------------------------------|------------------|
| V_{CES} | $T_J = 25^\circ\text{C to } 150^\circ\text{C}$ | 600 | V |
| V_{CGR} | $T_J = 25^\circ\text{C to } 150^\circ\text{C}; R_{GE} = 1\text{ M}\Omega$ | 600 | V |
| V_{GES} | Continuous | ± 20 | V |
| V_{GEM} | Transient | ± 30 | V |
| I_{C25} | $T_C = 25^\circ\text{C}$ | 60 | A |
| I_{C110} | $T_C = 110^\circ\text{C}$ | 30 | A |
| I_{CM} | $T_C = 25^\circ\text{C}, 1\text{ ms}$ | 120 | A |
| SSOA (RBSOA) | $V_{GE} = 15\text{ V}, T_{VJ} = 125^\circ\text{C}, R_G = 33\ \Omega$ Clamped inductive load, $L = 100\ \mu\text{H}$ | $I_{CM} = 60$ @ $0.8 V_{CES}$ | A |
| P_C | $T_C = 25^\circ\text{C}$ | 200 | W |
| T_J | | -55 ... +150 | $^\circ\text{C}$ |
| T_{JM} | | 150 | $^\circ\text{C}$ |
| T_{stg} | | -55 ... +150 | $^\circ\text{C}$ |
| Maximum Lead and Tab temperature for soldering 1.6 mm (0.062 in.) from case for 10 s | | 300 | $^\circ\text{C}$ |
| M_d | Mounting torque, TO-247 AD | 1.13/10 | Nm/lb.in. |
| Weight | TO-268 | 4 | g |
| | TO-247 AD | 6 | g |

TO-268
(IXGT)

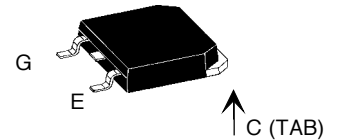

TO-247 AD

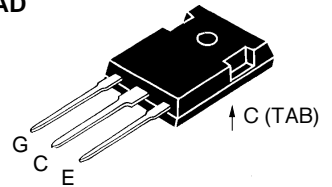

G = Gate, C = Collector,
E = Emitter, TAB = Collector

Features

- International standard packages JEDEC TO-247 SMD surface mountable and JEDEC TO-247 AD
- High frequency IGBT and antiparallel FRED in one package
- High current handling capability
- Newest generation HDMOS™ process
- MOS Gate turn-on - drive simplicity

Applications

- AC motor speed control
- DC servo and robot drives
- DC choppers
- Uninterruptible power supplies (UPS)
- Switched-mode and resonant-mode power supplies

Advantages

- Space savings (two devices in one package)
- High power density
- Optimized $V_{CE(sat)}$ and switching speeds for medium frequency applications

| Symbol | Test Conditions | Characteristic Values ($T_J = 25^\circ\text{C}$, unless otherwise specified) | | |
|---------------|--|---|--------|---------------------------|
| | | min. | typ. | max. |
| BV_{CES} | $I_C = 750\ \mu\text{A}, V_{GE} = 0\text{ V}$ BV_{CES} temperature coefficient | 600 | 0.072 | V %/K |
| $V_{GE(th)}$ | $I_C = 250\ \mu\text{A}, V_{CE} = V_{GE}$ $V_{GE(th)}$ temperature coefficient | 2.5 | -0.286 | V %/K |
| I_{CES} | $V_{CE} = 0.8 \cdot V_{CES}$ $V_{GE} = 0\text{ V}$ $T_J = 25^\circ\text{C}$ $T_J = 150^\circ\text{C}$ | | | 500 μA 3 mA |
| I_{GES} | $V_{CE} = 0\text{ V}, V_{GE} = \pm 20\text{ V}$ | | | $\pm 100\text{ nA}$ |
| $V_{CE(sat)}$ | $I_C = I_{C110}, V_{GE} = 15\text{ V}$ | | | 1.8 V |
| $V_{CE(sat)}$ | $I_C = I_{C110}, V_{GE} = 15\text{ V}$ $T_J = 150^\circ\text{C}$ | | | 2.0 V |

| Symbol | Test Conditions | Characteristic Values | | |
|--------------|--|--|------|----------|
| | | $(T_J = 25^\circ\text{C}, \text{ unless otherwise specified})$ | | |
| | | min. | typ. | max. |
| g_{fs} | $I_C = I_{C110}; V_{CE} = 10\text{ V},$ Pulse test, $t \leq 300\ \mu\text{s}, \text{ duty cycle } \leq 2\%$ | | 25 | S |
| C_{ies} | $V_{CE} = 25\text{ V}, V_{GE} = 0\text{ V}, f = 1\text{ MHz}$ | | 2710 | pF |
| C_{oes} | | | 240 | pF |
| C_{res} | | | 50 | pF |
| Q_g | $I_C = I_{C110}; V_{GE} = 15\text{ V}, V_{CE} = 0.5 V_{CES}$ | | 110 | 150 nC |
| Q_{ge} | | | 22 | 35 nC |
| Q_{gc} | | | 40 | 75 nC |
| $t_{d(on)}$ | Inductive load, $T_J = 25^\circ\text{C}$ | | 25 | ns |
| t_{ri} | $I_C = I_{C110}; V_{GE} = 15\text{ V}, L = 100\ \mu\text{H},$ $V_{CE} = 0.8 V_{CES}, R_G = R_{off} = 4.7\ \Omega$ | | 30 | ns |
| $t_{d(off)}$ | | | 130 | 220 ns |
| t_{fi} | | Remarks: Switching times may increase for $V_{CE} (\text{Clamp}) > 0.8 \cdot V_{CES}$ higher T_J or increased R_G | | 100 |
| E_{off} | | | 1.0 | 2.0 mJ |
| $t_{d(on)}$ | Inductive load, $T_J = 150^\circ\text{C}$ | | 25 | ns |
| t_{ri} | $I_C = I_{C110}; V_{GE} = 15\text{ V}, L = 100\ \mu\text{H},$ $V_{CE} = 0.8 V_{CES}, R_G = R_{off} = 4.7\ \Omega$ | | 35 | ns |
| E_{on} | | | 1 | mJ |
| $t_{d(off)}$ | | Remarks: Switching times may increase for $V_{CE} (\text{Clamp}) > 0.8 \cdot V_{CES}$ higher T_J or increased R_G | | 200 |
| t_{fi} | | | 230 | ns |
| E_{off} | | | 2.5 | mJ |
| R_{thJC} | | | | 0.62 K/W |
| R_{thCK} | | | 0.25 | K/W |

| Symbol | Test Conditions | Characteristic Values | | |
|------------|---|--|------|-------|
| | | $(T_J = 25^\circ\text{C}, \text{ unless otherwise specified})$ | | |
| | | min. | typ. | max. |
| V_F | $I_F = I_{C110}; V_{GE} = 0\text{ V},$ Pulse test, $t \leq 300\ \mu\text{s}, \text{ duty cycle } d \leq 2\%$ | | | 1.6 V |
| I_{RM} | $I_F = I_{C110}; V_{GE} = 0\text{ V}, -di_F/dt = 240\text{ A}/\mu\text{s}$ $V_R = 360\text{ V}$ | | 10 | 15 A |
| t_{rr} | $I_F = 1\text{ A}; -di/dt = 100\text{ A}/\mu\text{s}; V_R = 30\text{ V}$ | | 35 | 50 ns |
| R_{thJC} | | | | 1 K/W |

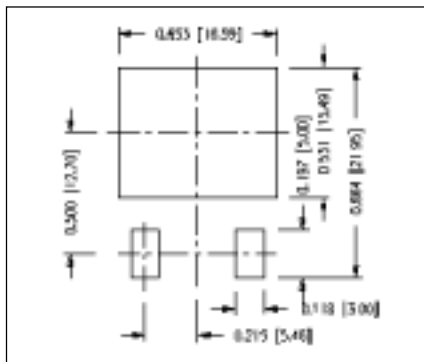

Min Recommended Footprint

TO-247 AD Outline

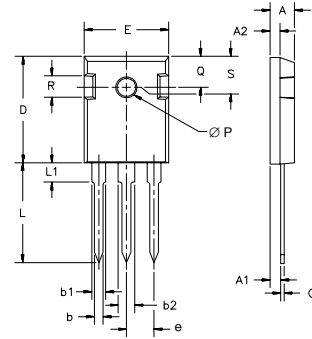

| Dim. | Millimeter | | Inches | |
|----------------|------------|-------|--------|-------|
| | Min. | Max. | Min. | Max. |
| A | 4.7 | 5.3 | .185 | .209 |
| A ₁ | 2.2 | 2.54 | .087 | .102 |
| A ₂ | 2.2 | 2.6 | .087 | .102 |
| b | 1.0 | 1.4 | .040 | .055 |
| b ₁ | 1.65 | 2.13 | .065 | .084 |
| b ₂ | 2.87 | 3.12 | .113 | .123 |
| C | .4 | .8 | .016 | .031 |
| D | 20.80 | 21.46 | .819 | .845 |
| E | 15.75 | 16.26 | .610 | .640 |
| e | 5.20 | 5.72 | 0.205 | 0.225 |
| L | 19.81 | 20.32 | .780 | .800 |
| L ₁ | | 4.50 | | .177 |
| ØP | 3.55 | 3.65 | .140 | .144 |
| Q | 5.89 | 6.40 | 0.232 | 0.252 |
| R | 4.32 | 5.49 | .170 | .216 |
| S | 6.15 | BSC | .242 | BSC |

TO-247 AA (D³ PAK)

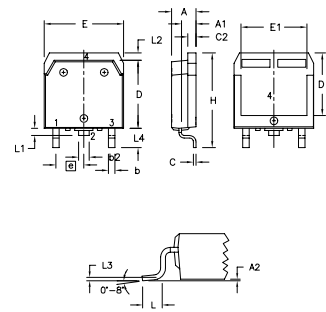

| Dim. | Millimeter | | Inches | |
|----------------|------------|-------|--------|------|
| | Min. | Max. | Min. | Max. |
| A | 4.9 | 5.1 | .193 | .201 |
| A ₁ | 2.7 | 2.9 | .106 | .114 |
| A ₂ | .02 | .25 | .001 | .010 |
| b | 1.15 | 1.45 | .045 | .057 |
| b ₁ | 1.9 | 2.1 | .075 | .083 |
| C | .4 | .65 | .016 | .026 |
| D | 13.80 | 14.00 | .543 | .551 |
| E | 15.85 | 16.05 | .624 | .632 |
| E ₁ | 13.3 | 13.6 | .524 | .535 |
| e | 5.45 | BSC | .215 | BSC |
| H | 18.70 | 19.10 | .736 | .752 |
| L | 2.40 | 2.70 | .094 | .106 |
| L ₁ | 1.20 | 1.40 | .047 | .055 |
| L ₂ | 1.00 | 1.15 | .039 | .045 |
| L ₃ | 0.25 | BSC | .010 | BSC |
| L ₄ | 3.80 | 4.10 | .150 | .161 |

IXYS reserves the right to change limits, test conditions, and dimensions.

Fig. 1. Saturation Voltage Characteristics

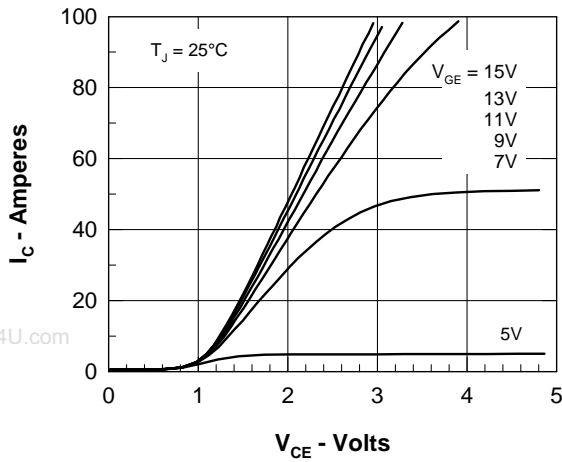

Fig. 2. Extended Output Characteristics

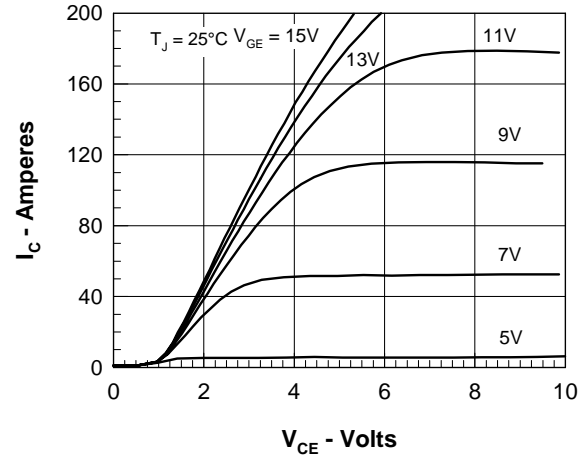

Fig. 3. Saturation Voltage Characteristics

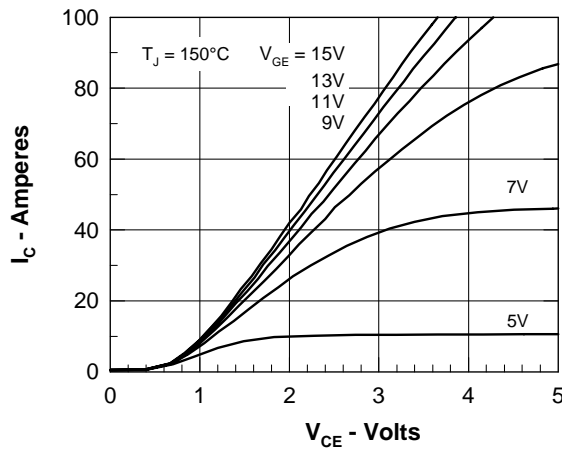

Fig. 4. Temperature Dependence of $V_{CE(sat)}$

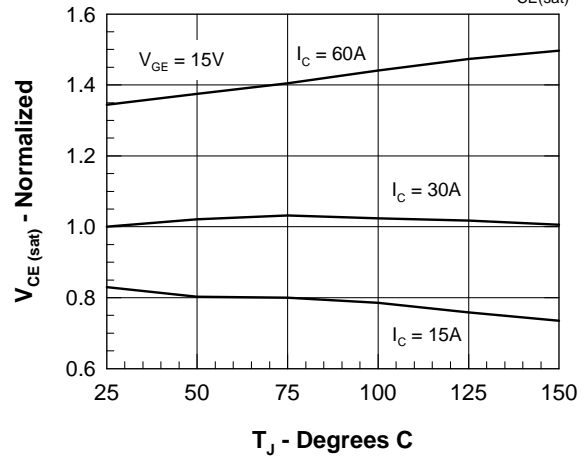

Fig. 5. Admittance Curves

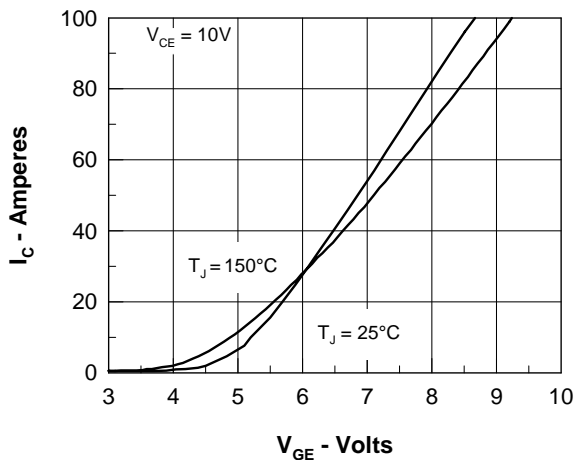

Fig. 6. Temperature Dependence of BV_{DSS} & $V_{GE(th)}$

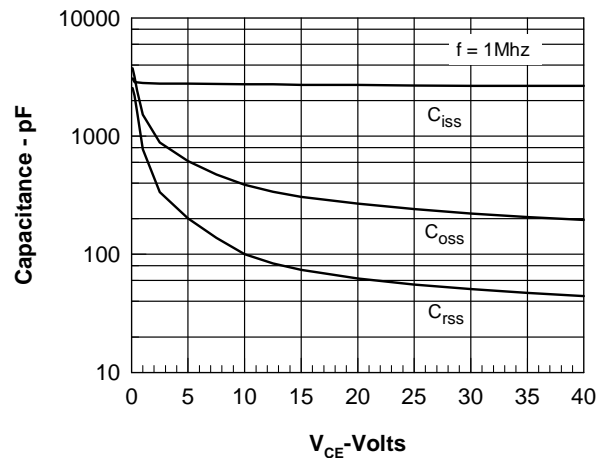

Fig. 7. Dependence of $E_{(OFF)}$ and $E_{(ON)}$ on I_C .

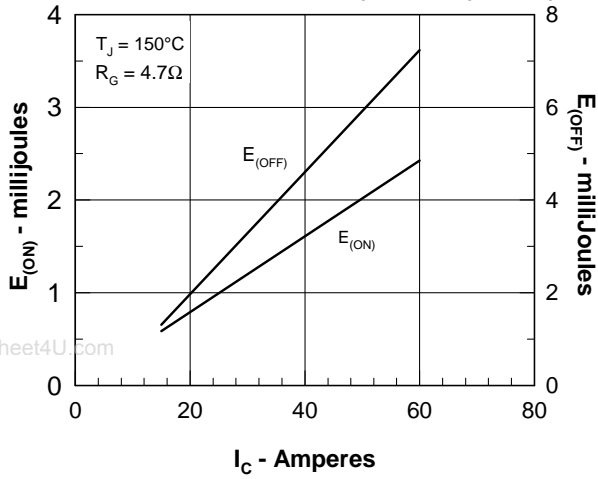

Fig. 8. Dependence of $E_{(OFF)}$ on R_G .

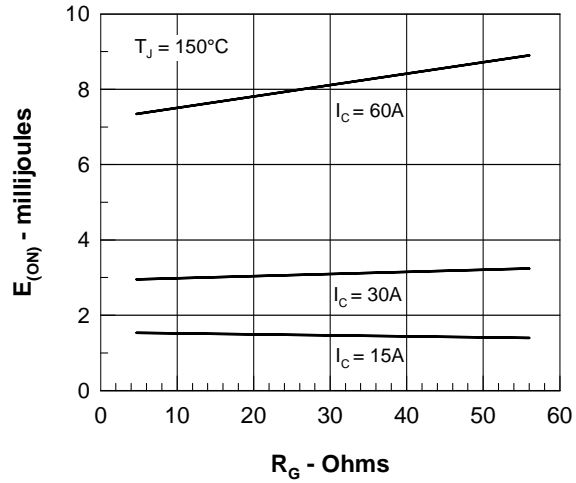

Fig. 9. Gate Charge

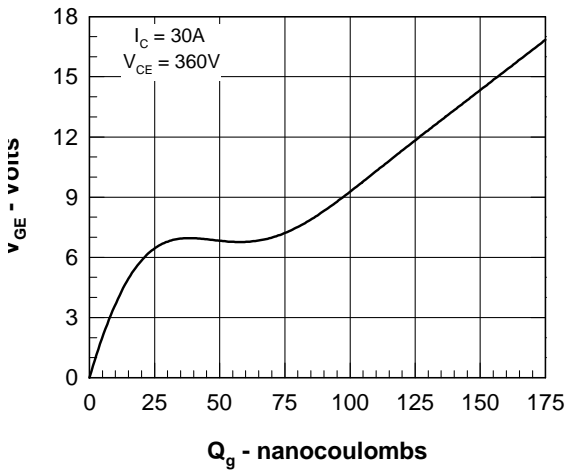

Fig. 10. Turn-off Safe Operating Area

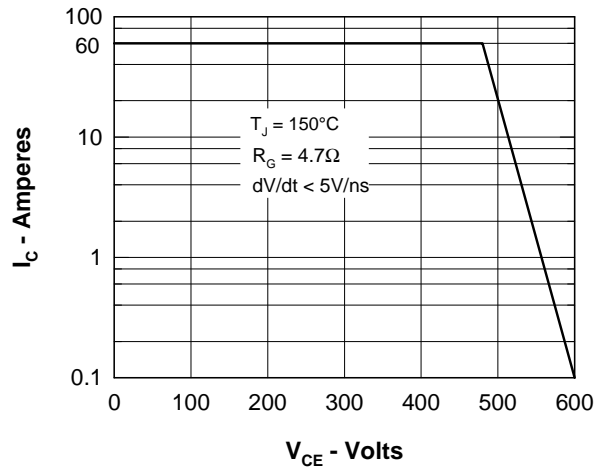
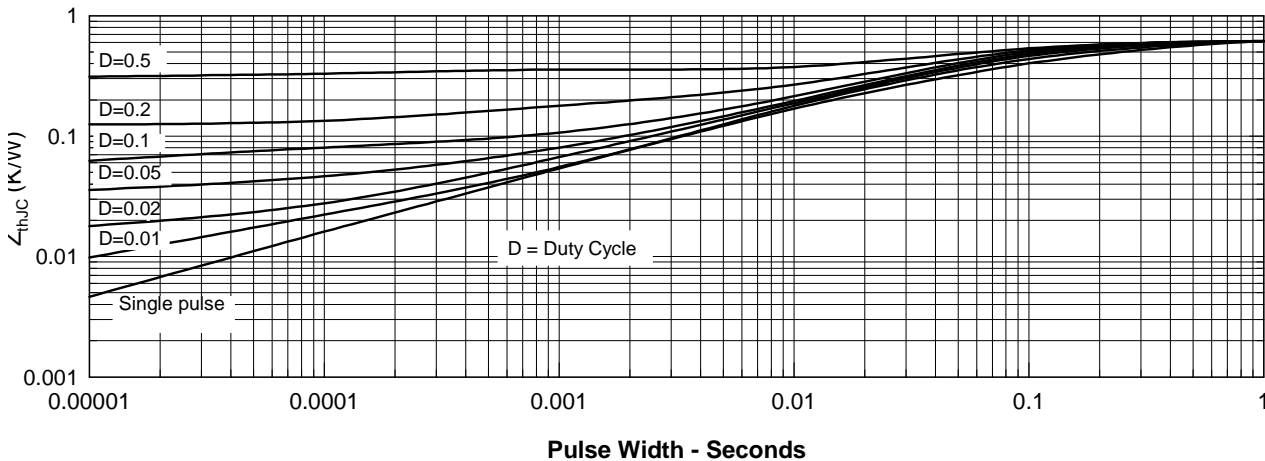

Fig. 11. IGBT Transient Thermal Resistance



IXYS reserves the right to change limits, test conditions, and dimensions.

IXYS MOSFETs and IGBTs are covered by one or more of the following U.S. patents:

| | | | | | | |
|-----------|-----------|-----------|-----------|-----------|-----------|-----------|
| 4,835,592 | 4,881,106 | 5,017,508 | 5,049,961 | 5,187,117 | 5,486,725 | 5,908,983 |
| 4,850,072 | 4,931,844 | 5,034,796 | 5,063,307 | 5,237,481 | 5,381,025 | |

Fig. 12. Forward current versus voltage drop.

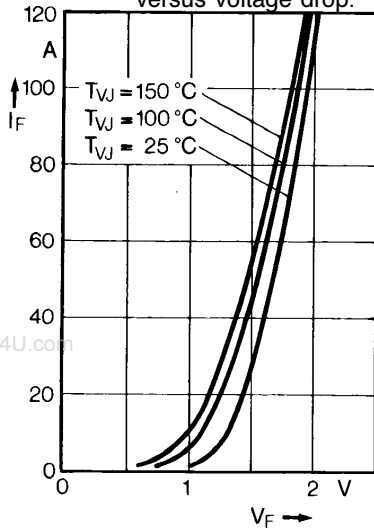

Fig. 13. Recovery charge versus $-di_F/dt$.

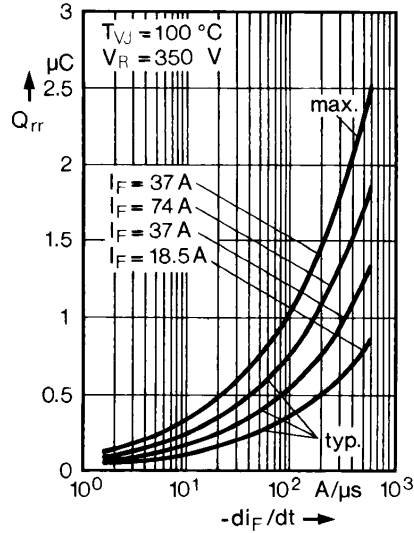

Fig. 14. Peak reverse current versus $-di_F/dt$.

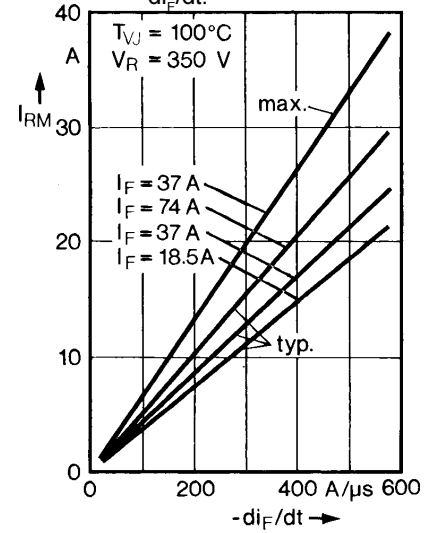

Fig. 15. Dynamic parameters versus junction temperature.

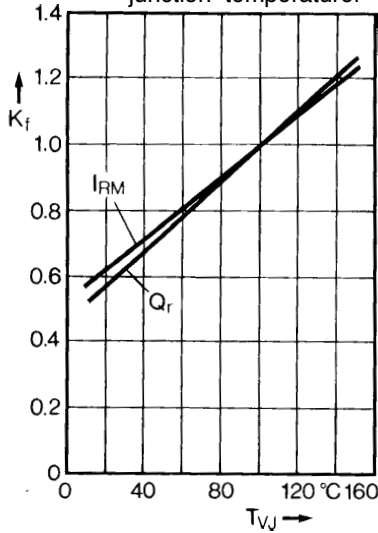

Fig. 16. Reverse recovery time vs $-di_F/dt$.

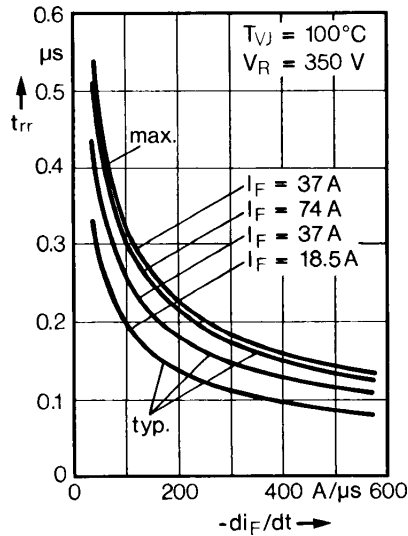

Fig. 17. Forward voltage recovery and time versus $-di_F/dt$.

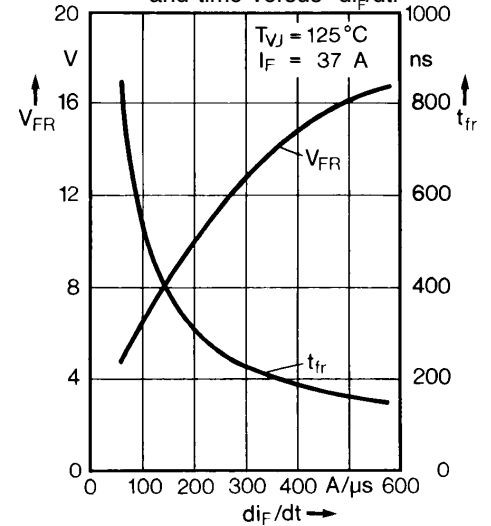

Fig. 18. Transient thermal resistance junction to case.

