

# High Voltage IGBT

**IXGH 32N170**  
**IXGT 32N170**

$V_{CES} = 1700 \text{ V}$   
 $I_{C25} = 75 \text{ A}$   
 $V_{CE(sat)} = 3.3 \text{ V}$   
 $t_{fi(typ)} = 250 \text{ ns}$

## Preliminary Data Sheet

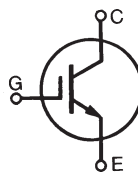

| Symbol  | Test Conditions   | Maximum Ratings                  |                  |
|---|---|----------------------------------|------------------|
| $V_{CES}$   | $T_J = 25^\circ\text{C to } 150^\circ\text{C}$  | 1700                             | V                |
| $V_{CGR}$   | $T_J = 25^\circ\text{C to } 150^\circ\text{C}; R_{GE} = 1 \text{ M}\Omega$                    | 1700                             | V                |
| $V_{GES}$   | Continuous  | $\pm 20$                         | V                |
| $V_{GEM}$   | Transient   | $\pm 30$                         | V                |
| $I_{C25}$   | $T_C = 25^\circ\text{C}$  | 75                               | A                |
| $I_{C90}$   | $T_C = 90^\circ\text{C}$  | 32                               | A                |
| $I_{CM}$  | $T_C = 25^\circ\text{C}, 1 \text{ ms}$  | 200                              | A                |
| <b>SSOA (RBSOA)</b>   | $V_{GE} = 15 \text{ V}, T_{VJ} = 125^\circ\text{C}, R_G = 5 \Omega$<br>Clamped inductive load | $I_{CM} = 90$<br>@ $0.8 V_{CES}$ | A                |
| $P_C$   | $T_C = 25^\circ\text{C}$  | 350                              | W                |
| $T_J$   |   | -55 ... +150                     | $^\circ\text{C}$ |
| $T_{JM}$  |   | 150                              | $^\circ\text{C}$ |
| $T_{stg}$   |   | -55 ... +150                     | $^\circ\text{C}$ |
| Maximum Lead temperature for soldering<br>1.6 mm (0.062 in.) from case for 10 s |   | 300                              | $^\circ\text{C}$ |
| Maximum Tab temperature for soldering SMD devices for 10 s                      |   | 260                              | $^\circ\text{C}$ |
| $M_d$   | Mounting torque (M3)  | 1.13/10Nm/lb.in.                 |                  |
| <b>Weight</b>   |   | TO-247 AD                        | 6 g              |
|   |   | TO-268                           | 4 g              |

### TO-268 (IXGT)

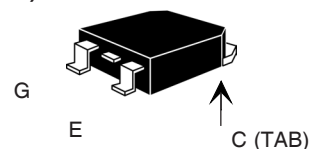

### TO-247 AD (IXGH)

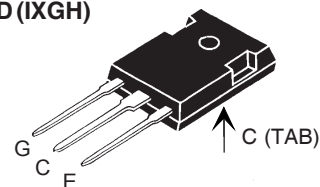

G = Gate, C = Collector,  
E = Emitter, TAB = Collector

### Features

- International standard packages  
JEDEC TO-268 and  
JEDEC TO-247 AD
- High current handling capability
- MOS Gate turn-on  
- drive simplicity
- Rugged NPT structure
- Molding epoxies meet UL 94 V-0  
flammability classification

### Applications

- Capacitor discharge & pulser circuits
- AC motor speed control
- DC servo and robot drives
- DC choppers
- Uninterruptible power supplies (UPS)
- Switched-mode and resonant-mode  
power supplies

### Advantages

- High power density
- Suitable for surface mounting
- Easy to mount with 1 screw,  
(isolated mounting screw hole)

| Symbol        | Test Conditions  | Characteristic Values<br>( $T_J = 25^\circ\text{C}$ , unless otherwise specified) |      |                      |
|---------------|--|---|------|----------------------|
|               |  | min.  | typ. | max.                 |
| $BV_{CES}$    | $I_C = 250 \mu\text{A}, V_{GE} = 0 \text{ V}$          | 1700  |      | V                    |
| $V_{GE(th)}$  | $I_C = 250 \mu\text{A}, V_{CE} = V_{GE}$               | 3.0   |      | V                    |
| $I_{CES}$     | $V_{CE} = 0.8 \cdot V_{CES}$<br>$V_{GE} = 0 \text{ V}$ | $T_J = 25^\circ\text{C}$  |      | 50 $\mu\text{A}$     |
|               |  | $T_J = 125^\circ\text{C}$   |      | 1 mA                 |
| $I_{GES}$     | $V_{CE} = 0 \text{ V}, V_{GE} = \pm 20 \text{ V}$      |   |      | $\pm 100 \text{ nA}$ |
| $V_{CE(sat)}$ | $I_C = I_{C90}, V_{GE} = 15 \text{ V}$                 | $T_J = 25^\circ\text{C}$  | 2.5  | 3.3 V                |
|               |  | $T_J = 125^\circ\text{C}$   | 3.0  | V                    |

| Symbol       | Test Conditions  | Characteristic Values<br>( $T_J = 25^\circ\text{C}$ , unless otherwise specified) |      |      |    |
|--------------|--|---|------|------|----|
|              |  | min.  | typ. | max. |    |
| $g_{fs}$     | $I_C = I_{C90}$ ; $V_{CE} = 10\text{V}$ ,<br>Pulse test, $t \leq 300\ \mu\text{s}$ , duty cycle $\leq 2\%$   | 22  | 30   | S    |    |
| $I_{C(ON)}$  | $V_{GE} = 10\text{V}$ , $V_{CE} = 10\text{V}$  |   | 120  | A    |    |
| $C_{ies}$    | $V_{CE} = 25\text{V}$ , $V_{GE} = 0\text{V}$ , $f = 1\text{MHz}$   |   | 3500 | pF   |    |
| $C_{oes}$    |  |   | 165  | pF   |    |
| $C_{res}$    |  |   | 40   | pF   |    |
| $Q_{ge}$     | $I_C = I_{C90}$ , $V_{GE} = 15\text{V}$ , $V_{CE} = 0.5 V_{CES}$   |   | 155  | nC   |    |
| $Q_{gc}$     |  |   | 30   | nC   |    |
| $Q_{gc}$     |  |   | 51   | nC   |    |
| $t_{d(on)}$  | <b>Inductive load, <math>T_J = 25^\circ\text{C}</math></b><br>$I_C = I_{C90}$ , $V_{GE} = 15\text{V}$<br>$V_{CE} = 0.6 V_{CES}$ , $R_G = R_{off} = 2.7\ \Omega$  |   | 45   | ns   |    |
| $t_{ri}$     |  |   | 38   | ns   |    |
| $t_{d(off)}$ |  |   | 270  | 500  | ns |
| $t_{fi}$     |  |   | 250  | 500  | ns |
| $E_{off}$    |  |   | 11   | 20   | mJ |
| $t_{d(on)}$  | <b>Inductive load, <math>T_J = 125^\circ\text{C}</math></b><br>$I_C = I_{C90}$ , $V_{GE} = 15\text{V}$<br>$V_{CE} = 0.6 V_{CES}$ , $R_G = R_{off} = 2.7\ \Omega$ |   | 48   | ns   |    |
| $t_{ri}$     |  |   | 42   | ns   |    |
| $E_{on}$     |  |   | 6.0  | mJ   |    |
| $t_{d(off)}$ |  |   | 360  | ns   |    |
| $t_{fi}$     |  |   | 560  | ns   |    |
| $E_{off}$    |  | 14  | mJ   |      |    |
| $R_{thJC}$   |  |   | 0.35 | KW   |    |
| $R_{thCK}$   | (TO-247)   | 0.25  |      | KW   |    |

### Min Recommended Footprint

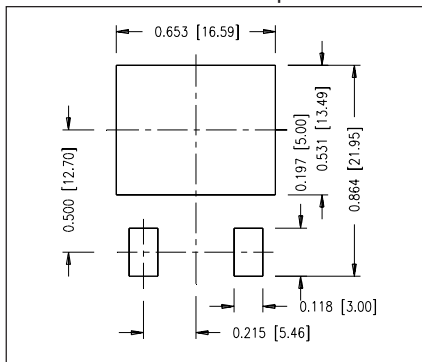

### TO-247 AD Outline

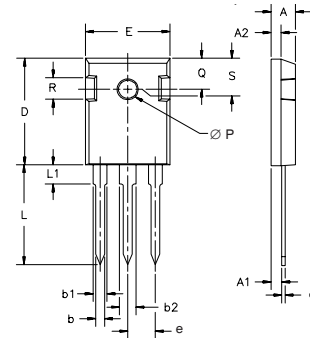

| Dim.           | Millimeter |       | Inches |       |
|----------------|------------|-------|--------|-------|
|                | Min.       | Max.  | Min.   | Max.  |
| A              | 4.7        | 5.3   | .185   | .209  |
| A <sub>1</sub> | 2.2        | 2.54  | .087   | .102  |
| A <sub>2</sub> | 2.2        | 2.6   | .059   | .098  |
| b              | 1.0        | 1.4   | .040   | .055  |
| b <sub>1</sub> | 1.65       | 2.13  | .065   | .084  |
| b <sub>2</sub> | 2.87       | 3.12  | .113   | .123  |
| C              | .4         | .8    | .016   | .031  |
| D              | 20.80      | 21.46 | .819   | .845  |
| E              | 15.75      | 16.26 | .610   | .640  |
| e              | 5.20       | 5.72  | 0.205  | 0.225 |
| L              | 19.81      | 20.32 | .780   | .800  |
| L1             |            | 4.50  |        | .177  |
| ∅P             | 3.55       | 3.65  | .140   | .144  |
| Q              | 5.89       | 6.40  | 0.232  | 0.252 |
| R              | 4.32       | 5.49  | .170   | .216  |
| S              | 6.15       | BSC   | 242    | BSC   |

### TO-268 Outline

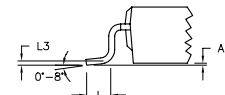
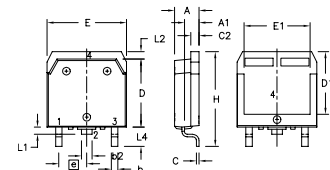

| Dim.           | Millimeter |       | Inches |      |
|----------------|------------|-------|--------|------|
|                | Min.       | Max.  | Min.   | Max. |
| A              | 4.9        | 5.1   | .193   | .201 |
| A <sub>1</sub> | 2.7        | 2.9   | .106   | .114 |
| A <sub>2</sub> | .02        | .25   | .001   | .010 |
| b              | 1.15       | 1.45  | .045   | .057 |
| b <sub>2</sub> | 1.9        | 2.1   | .75    | .83  |
| C              | .4         | .65   | .016   | .026 |
| D              | 13.80      | 14.00 | .543   | .551 |
| E              | 15.85      | 16.05 | .624   | .632 |
| E <sub>1</sub> | 13.3       | 13.6  | .524   | .535 |
| e              | 5.45       | BSC   | .215   | BSC  |
| H              | 18.70      | 19.10 | .736   | .752 |
| L              | 2.40       | 2.70  | .094   | .106 |
| L1             | 1.20       | 1.40  | .047   | .055 |
| L2             | 1.00       | 1.15  | .039   | .045 |
| L3             |            | 0.25  |        | .010 |
| L4             | 3.80       | 4.10  | .150   | .161 |

IXYS reserves the right to change limits, test conditions, and dimensions.

IXYS MOSFETs and IGBTs are covered by one or more of the following U.S. patents:

4,835,592 4,881,106 5,017,508 5,049,961 5,187,117 5,486,715 6,306,728B1 6,259,123B1  
4,850,072 4,931,844 5,034,796 5,063,307 5,237,481 5,381,025 6,404,065B1 6,162,665

www.DataSheet4U.com  
6,534,343 6,583,505

**Fig. 1. Output Characteristics @ 25 Deg. C**

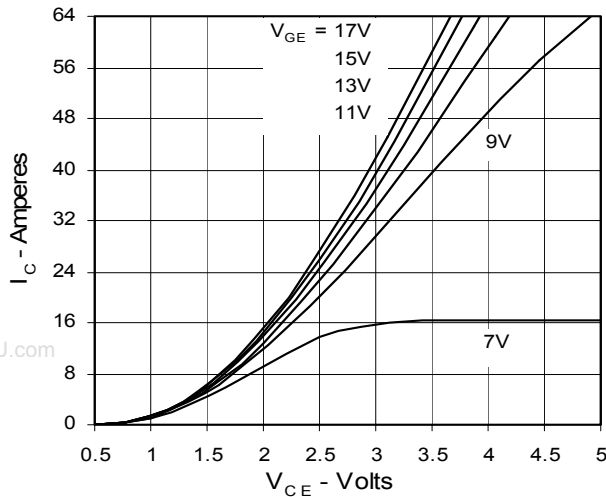

**Fig. 2. Extended Output Characteristics @ 25 deg. C**

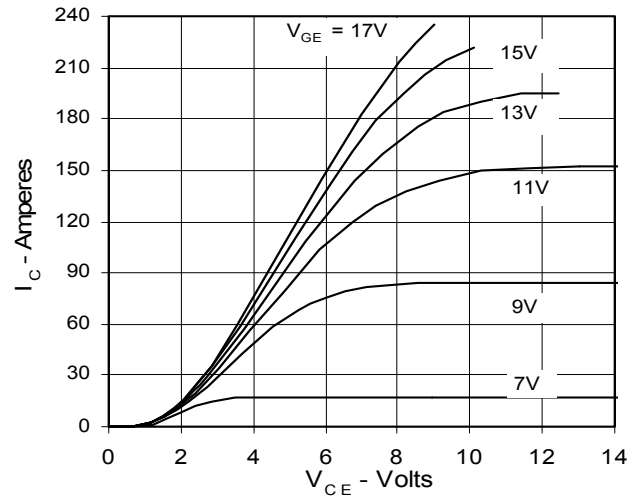

**Fig. 3. Output Characteristics @ 125 Deg. C**

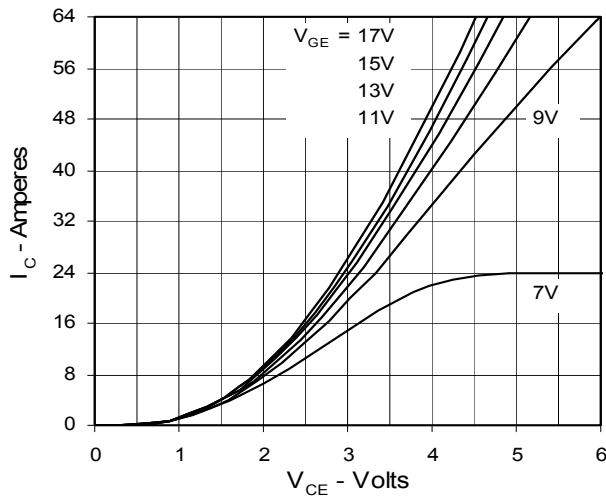

**Fig. 4. Dependence of  $V_{CE(sat)}$  on Temperature**

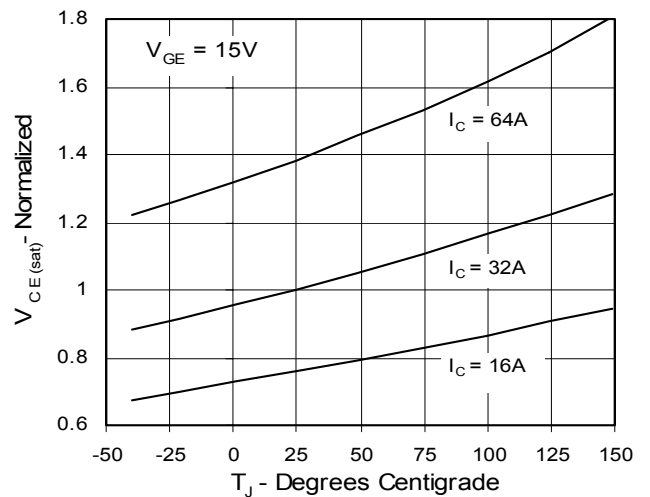

**Fig. 5. Collector-to-Emitter Voltage vs. Gate-to-Emitter voltage**

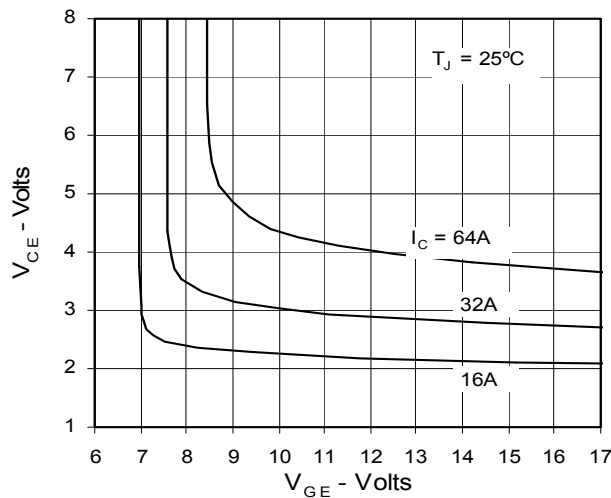

**Fig. 6. Input Admittance**

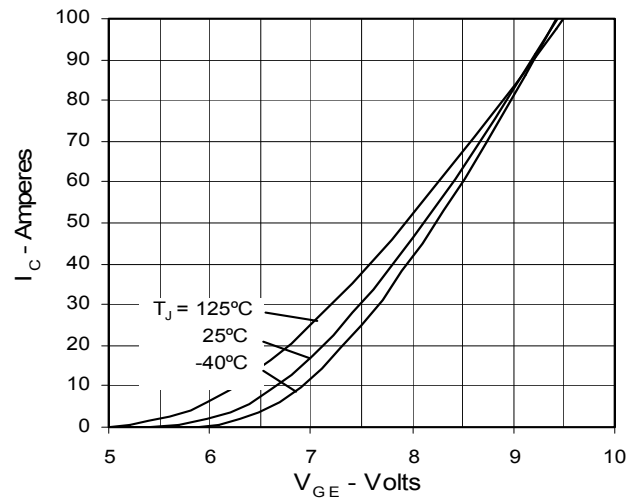

**Fig. 7. Transconductance**

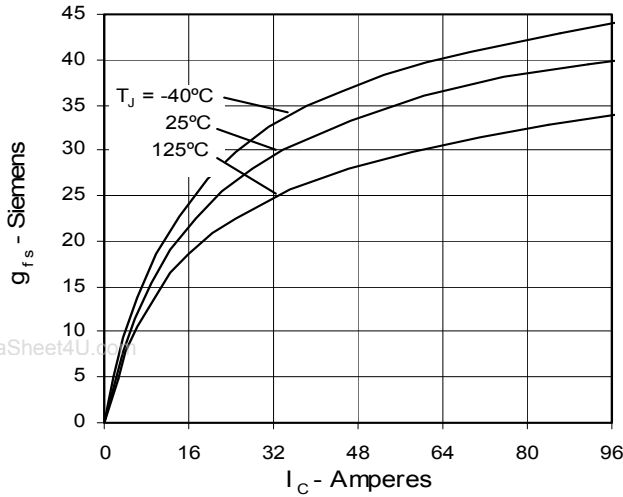

**Fig. 8. Dependence of  $E_{off}$  on  $R_G$**

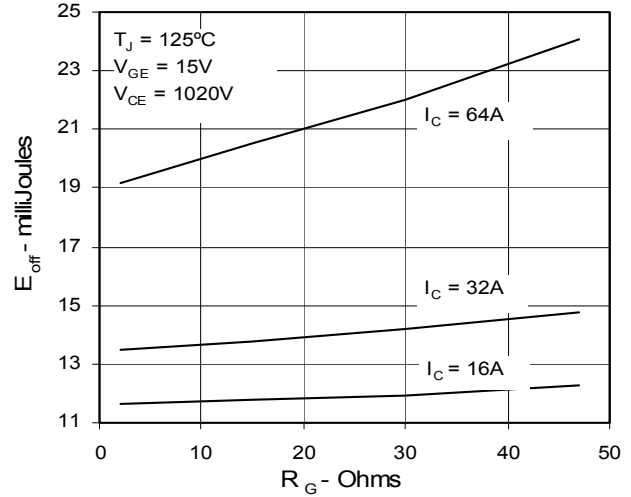

**Fig. 9. Dependence of  $E_{off}$  on  $I_C$**

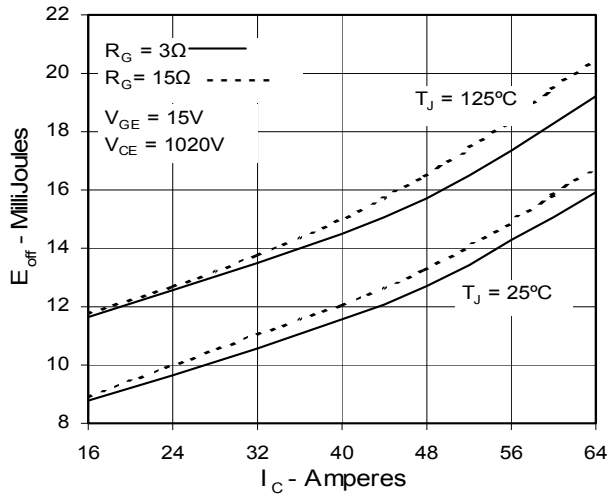

**Fig. 10. Dependence of  $E_{off}$  on Temperature**

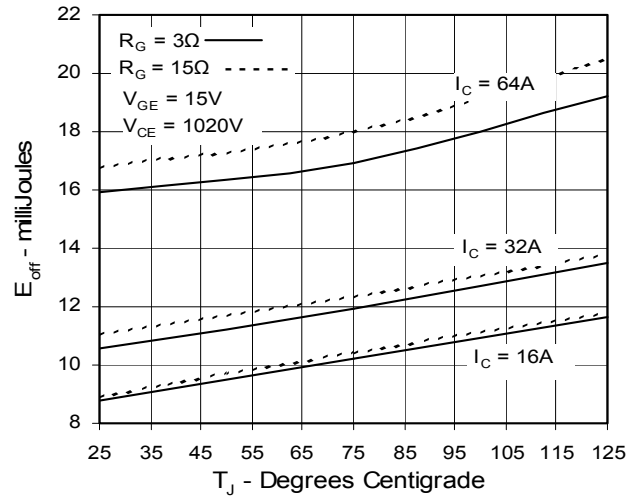

**Fig. 11. Gate Charge**

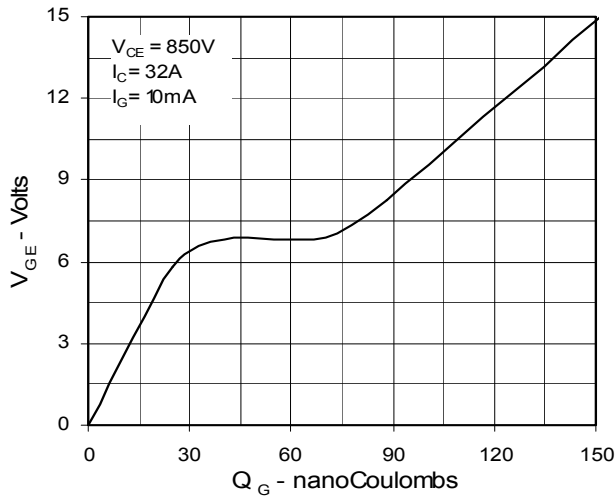

**Fig. 12. Capacitance**

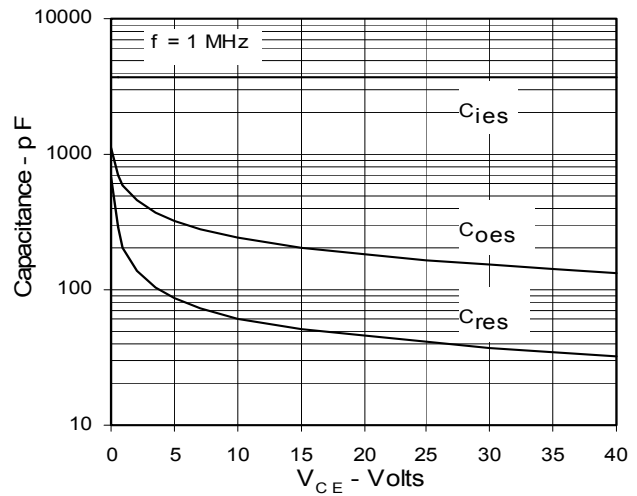

IXYS reserves the right to change limits, test conditions, and dimensions.

Fig. 13. Maximum Transient Thermal Resistance

