

High Voltage IGBT with Diode

IXGX 32N170AH1

$V_{CES} = 1700 \text{ V}$
 $I_{C25} = 32 \text{ A}$
 $V_{CE(sat)} = 5.0 \text{ V}$
 $t_{fi(typ)} = 50 \text{ ns}$

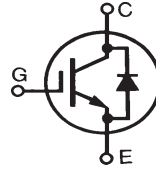

PLUS247 (IXGX)

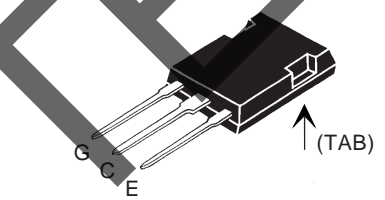

G = Gate,
E = Emitter,
C = Collector,
TAB = Collector

Symbol	Test Conditions	Maximum Ratings	
V_{CES}	$T_J = 25^\circ\text{C to } 150^\circ\text{C}$	1700	V
V_{CGR}	$T_J = 25^\circ\text{C to } 150^\circ\text{C}; R_{GE} = 1 \text{ M}\Omega$	1700	V
V_{GES}	Continuous	± 20	V
V_{GEM}	Transient	± 30	V
I_{C25}	$T_C = 25^\circ\text{C}$	32	A
I_{C90}	$T_C = 90^\circ\text{C}$	21	A
I_{F90}		18	A
I_{CM}	$T_C = 25^\circ\text{C}, 1 \text{ ms}$	110	A
SSOA (RBSOA)	$V_{GE} = 15 \text{ V}, T_{VJ} = 125^\circ\text{C}, R_G = 5\Omega$ Clamped inductive load	$I_{CM} = 70$ @ $0.8 V_{CES}$	A
t_{SC}	$T_J = 125^\circ\text{C}, V_{CE} = 1200 \text{ V}; V_{GE} = 15 \text{ V}, R_G = 10\Omega$	10	μs
P_C	$T_C = 25^\circ\text{C}$	350	W
T_J		-55 ... +150	$^\circ\text{C}$
T_{JM}		150	$^\circ\text{C}$
T_{stg}		-55 ... +150	$^\circ\text{C}$
F_C	Mounting force with clip	22...130/5...30	N/lb
Maximum lead temperature for soldering 1.6 mm (0.062 in.) from case for 10 s		300	$^\circ\text{C}$
Weight		6	g

Features

- High current handling capability
- MOS Gate turn-on
- drive simplicity
- Rugged NPT structure
- Molding epoxies meet UL 94 V-0 flammability classification

Applications

- Capacitor discharge & pulser circuits
- AC motor speed control
- DC servo and robot drives
- DC choppers
- Uninterruptible power supplies (UPS)
- Switched-mode and resonant-mode power supplies

Symbol	Test Conditions	Characteristic Values ($T_J = 25^\circ\text{C}$, unless otherwise specified)		
		min.	typ.	max.
BV_{CES}	$I_C = 1 \text{ mA}, V_{GE} = 0 \text{ V}$	1700		V
$V_{GE(th)}$	$I_C = 250 \mu\text{A}, V_{CE} = V_{GE}$	3.0		V
I_{CES}	$V_{CE} = 0.8 \cdot V_{CES}$ $V_{GE} = 0 \text{ V}$		$T_J = 25^\circ\text{C}$ $T_J = 125^\circ\text{C}$ Note 1	100 μA 3 mA
I_{GES}	$V_{CE} = 0 \text{ V}, V_{GE} = \pm 20 \text{ V}$			$\pm 100 \text{ nA}$
$V_{CE(sat)}$	$I_C = I_{C90}, V_{GE} = 15 \text{ V}$	$T_J = 25^\circ\text{C}$ $T_J = 125^\circ\text{C}$		4.0 V 4.8 V

Symbol	Test Conditions	Characteristic Values ($T_J = 25^\circ\text{C}$, unless otherwise specified)		
		Min.	Typ.	Max.
g_{fs}	$I_C = I_{C25}; V_{CE} = 10\text{ V}$ Note 2	16	30	S
C_{ies}	$V_{CE} = 25\text{ V}, V_{GE} = 0\text{ V}, f = 1\text{ MHz}$		3670	pF
C_{oes}			185	pF
C_{res}			44	pF
Q_g	$I_C = I_{C90}, V_{GE} = 15\text{ V}, V_{CE} = 0.5 V_{CES}$		157	nC
Q_{ge}			25	nC
Q_{gc}			57	nC
$t_{d(on)}$	Inductive load, $T_J = 25^\circ\text{C}$		27	ns
t_{ri}	$I_C = I_{C25}, V_{GE} = 15\text{ V}$		50	ns
E_{on}	$R_G = 2.7\ \Omega, V_{CE} = 0.5 V_{CES}$		4.1	mJ
$t_{d(off)}$			270	500 ns
t_{fi}			50	100 ns
E_{off}			1.25	2.5 mJ
$t_{d(on)}$	Inductive load, $T_J = 125^\circ\text{C}$		27	ns
t_{ri}	$I_C = I_{C25}, V_{GE} = 15\text{ V}$		47	ns
E_{on}	$R_G = 2.7\ \Omega, V_{CE} = 0.5 V_{CES}$		5.2	mJ
$t_{d(off)}$			280	ns
t_{fi}			82	ns
E_{off}			1.7	mJ
R_{thJC}				0.35 K/W
R_{thCK}			0.15	K/W

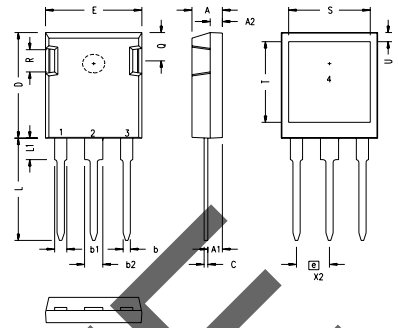
PLUS247 Outline (IXGX)

SYM	INCHES		MILLIMETERS	
	MIN	MAX	MIN	MAX
A	.190	.205	4.83	5.21
A1	.090	.100	2.29	2.54
A2	.075	.085	1.91	2.16
b	.045	.055	1.14	1.40
b1	.075	.084	1.91	2.13
b2	.115	.123	2.92	3.12
C	.024	.031	0.61	0.80
D	.819	.840	20.80	21.34
E	.620	.635	15.75	16.13
e	.215 BSC		5.45 BSC	
L	.780	.800	19.81	20.32
L1	.150	.170	3.81	4.32
Q	.220	.244	5.59	6.20
R	.170	.190	4.32	4.83
S	.520	.540	13.21	13.72
T	.620	.640	15.75	16.26
U	.065	.080	1.65	2.03

- 1 - GATE
- 2 - DRAIN (COLLECTOR)
- 3 - SOURCE (EMITTER)
- 4 - NO CONNECTION

NOTE: This drawing will meet all dimensions requirement of JEDEC outline TO-247AD except screw hole.

Symbol	Test Conditions	Characteristic Values ($T_J = 25^\circ\text{C}$ unless otherwise specified)		
		Min.	Typ.	Max.
V_F	$I_F = 60\text{ A}, V_{GE} = 0\text{ V}$, Pulse test, $t \leq 300\ \mu\text{s}$, duty cycle $d \leq 2\%$ $T_J = 150^\circ\text{C}$		2.4	2.7 V
I_{RM}	$I_F = 60\text{ A}, V_{GE} = 0\text{ V}$, $-di_F/dt = 600\text{ A}/\mu\text{s}$ $V_R = 1200\text{ V}$ $T_J = 125^\circ\text{C}$		50	A
t_{rr}	$T_J = 125^\circ\text{C}$		150	ns
R_{thJC}				0.35 K/W

- Notes: 1. Device must be heatsunk for high temperature leakage current measurements to avoid thermal runaway.
2. Pulse test, $t \leq 300\ \mu\text{s}$, duty cycle $d \leq 2\%$

IXYS reserves the right to change limits, test conditions, and dimensions.

IXYS MOSFETs and IGBTs are covered by one or more of the following U.S. patents:	4,835,592	4,931,844	5,049,961	5,237,481	6,162,665	6,404,065 B1	6,683,344	6,727,585
	4,850,072	5,017,508	5,063,307	5,381,025	6,259,123 B1	6,534,343	6,710,405 B2	6,759,692
	4,881,106	5,034,796	5,187,117	5,486,715	6,306,728 B1	6,583,505	6,710,463	6,771,478 B2

Fig. 1. Output Characteristics @ 25°C

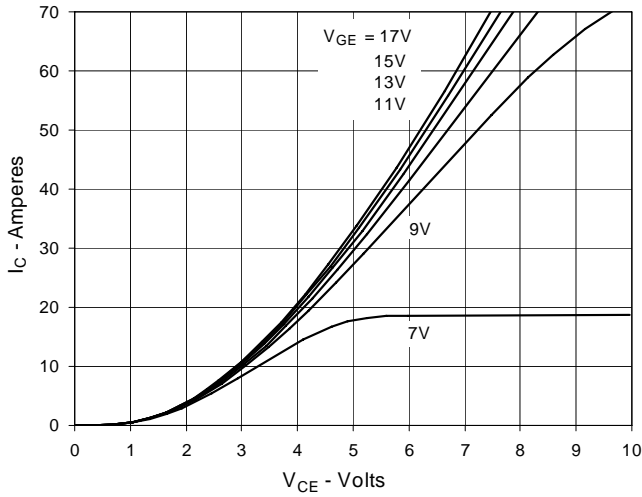

Fig. 2. Extended Output Characteristics @ 25°C

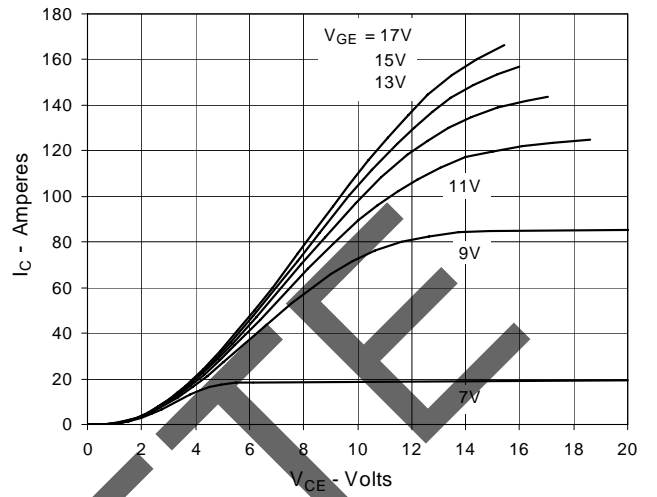

Fig. 3. Output Characteristics @ 125°C

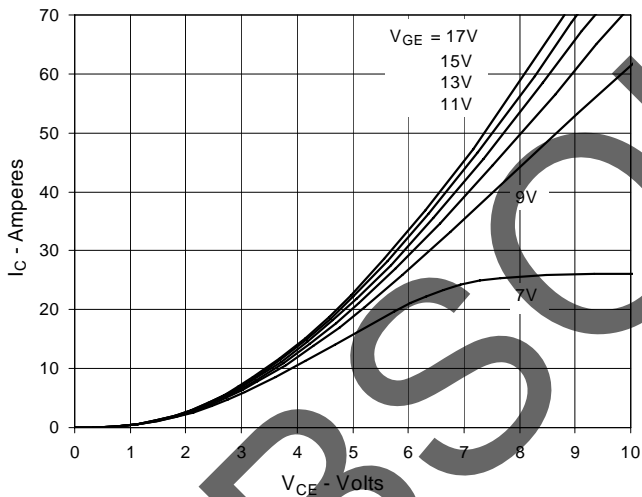

Fig. 4. Dependence of $V_{CE(sat)}$ on Junction Temperature

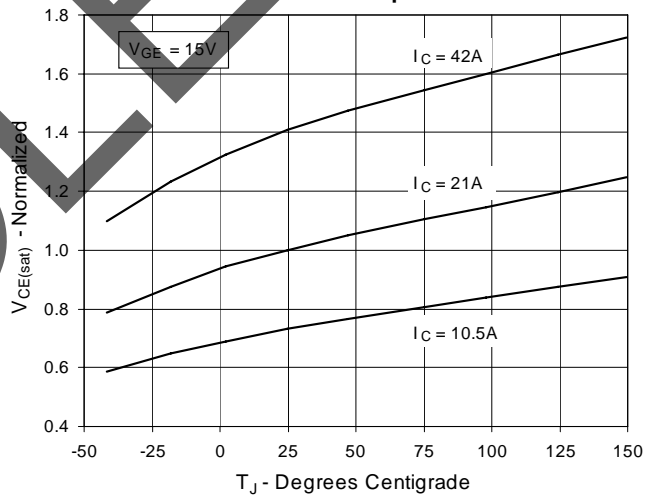

Fig. 5. Collector-to-Emitter Voltage vs. Gate-to-Emitter Voltage

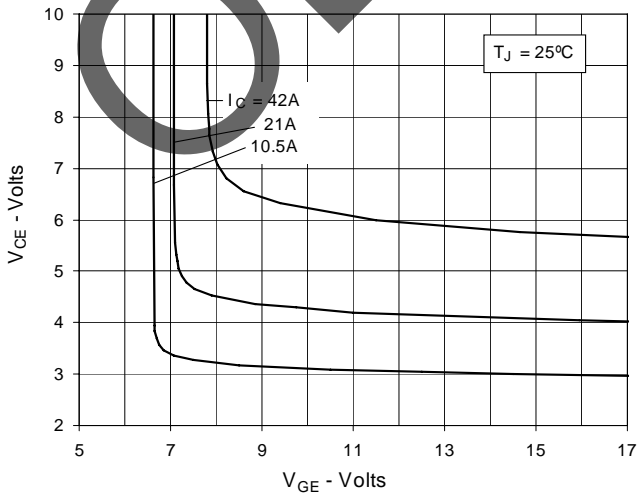

Fig. 6. Input Admittance

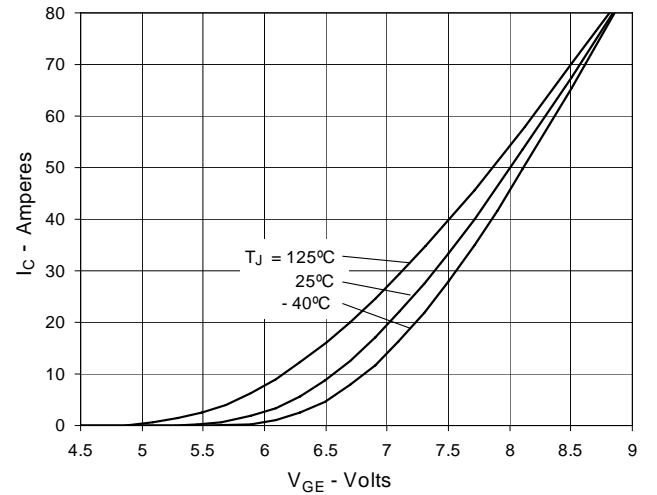

Fig. 7. Transconductance

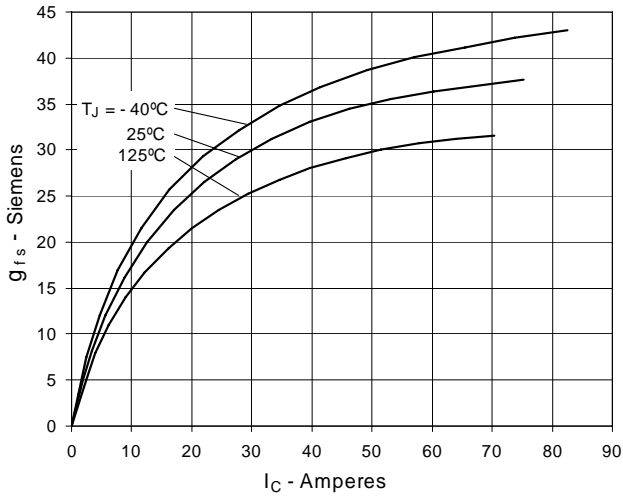

Fig. 8. Inductive Switching Energy Loss vs. Gate Resistance

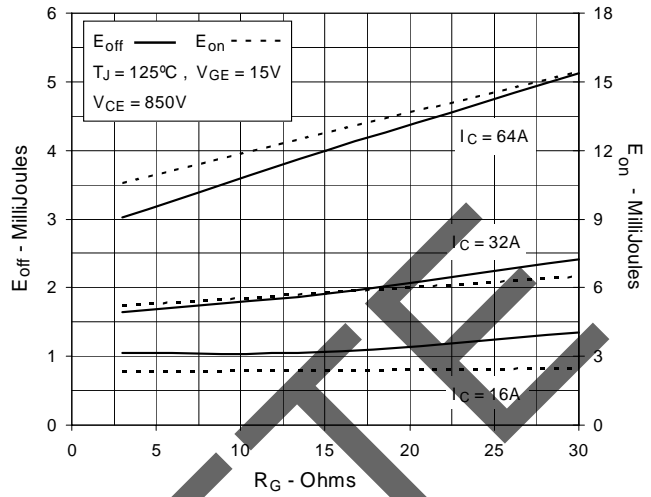

Fig. 9. Inductive Switching Energy Loss vs. Collector Current

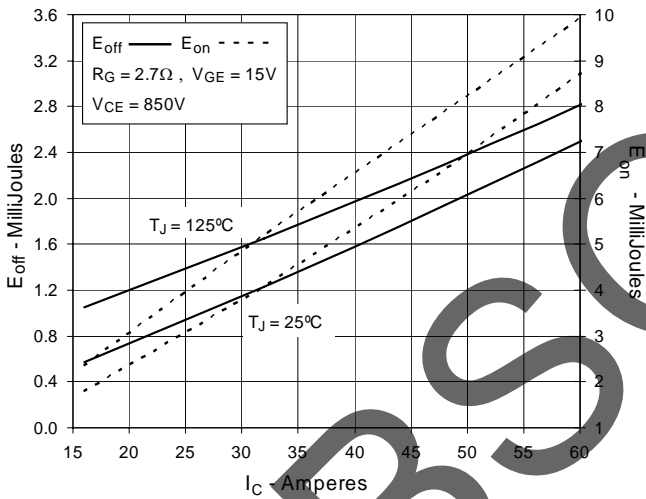

Fig. 10. Inductive Switching Energy Loss vs. Junction Temperature

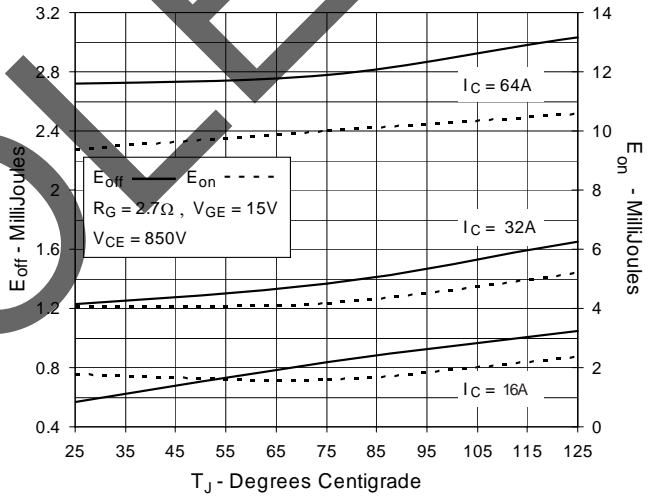

Fig. 11. Gate Charge

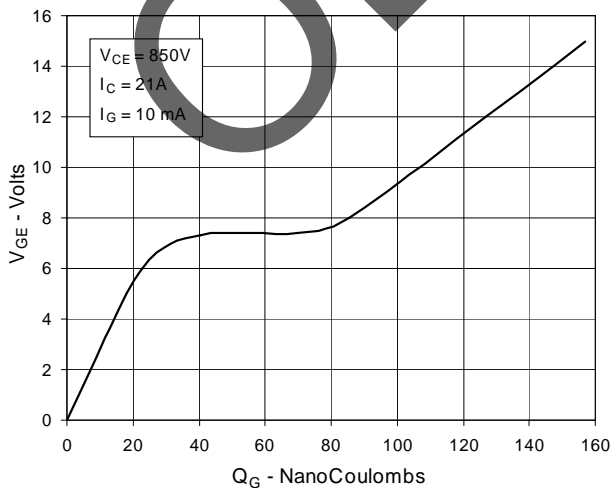

Fig. 12. Capacitance

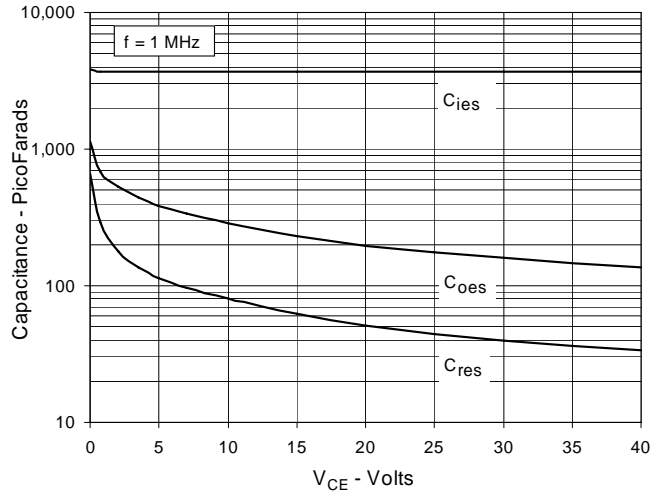

Fig. 13. Reverse-Bias Safe Operating Area

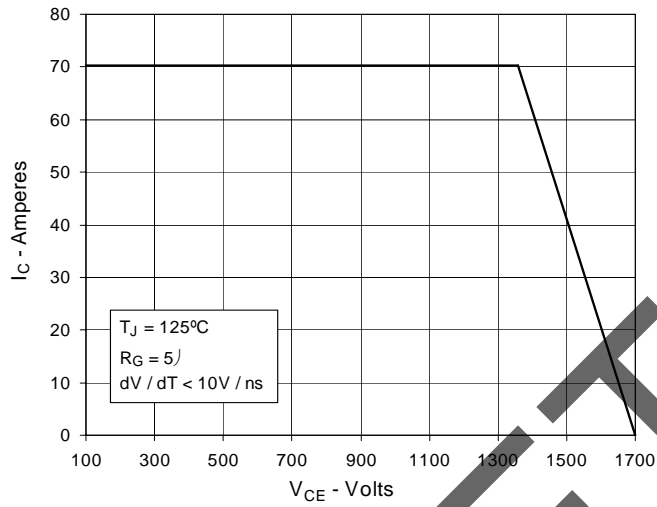
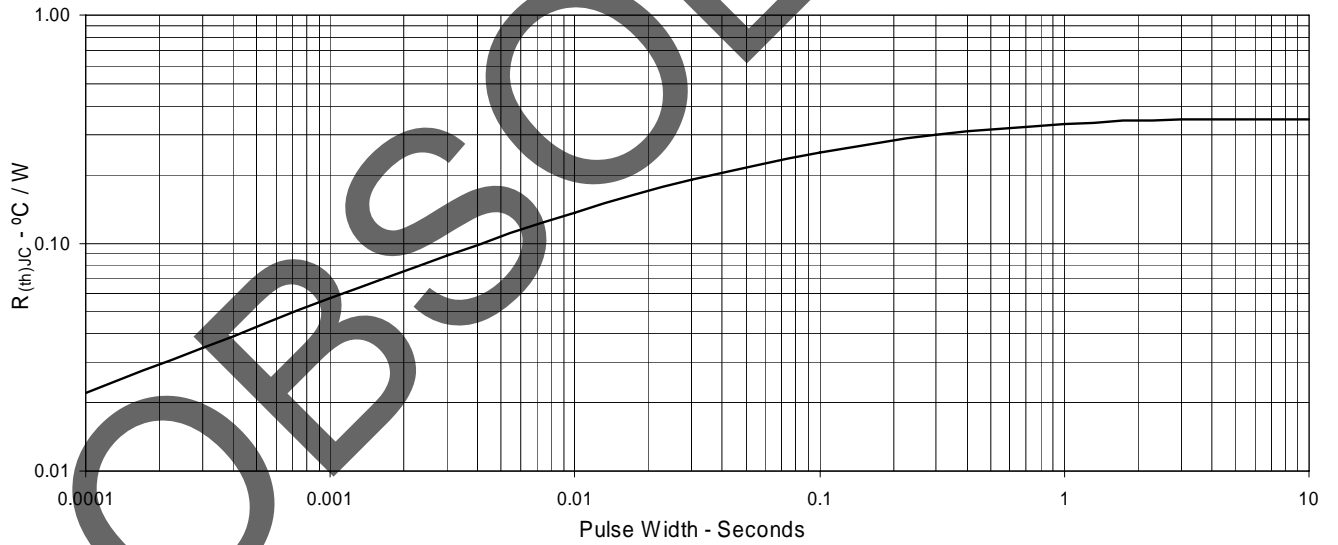

Fig. 14. Maximum Transient Thermal Resistance



Fast Recovery Diode Curves

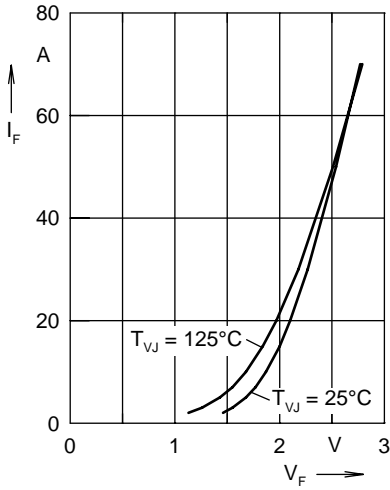

Fig. 15 Typ. forward current I_F versus V_F

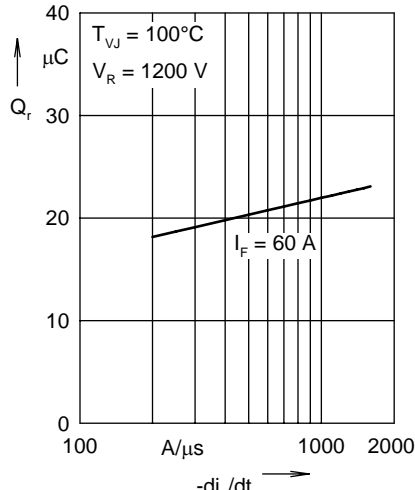

Fig. 16 Typ. reverse recovery charge Q_r versus $-di_F/dt$

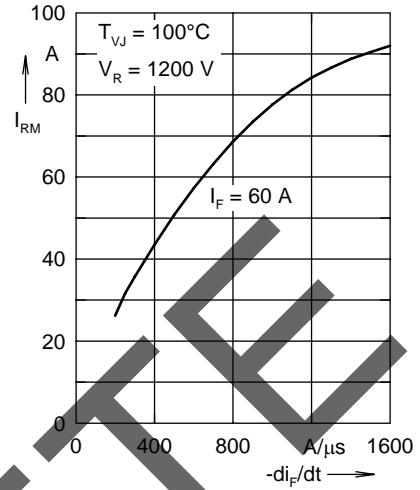

Fig. 17 Typ. peak reverse current I_{RM} versus $-di_F/dt$

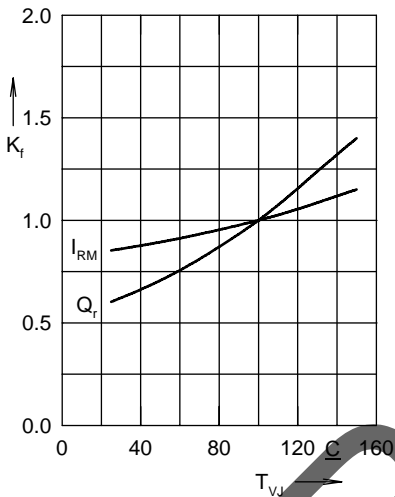

Fig. 18 Dynamic parameters K_f , I_{RM} , Q_r versus T_{VJ}

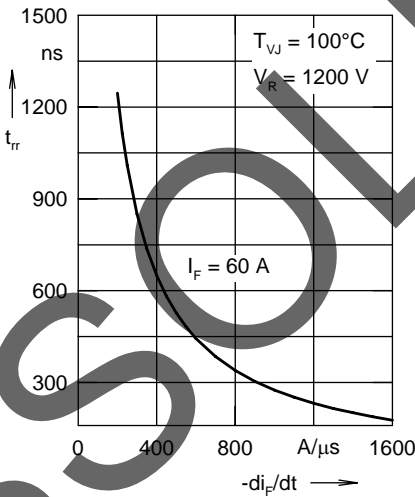

Fig. 19 Typ. recovery time t_{tr} versus $-di_F/dt$

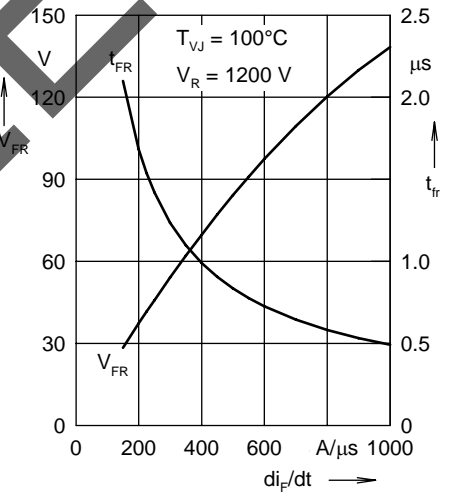

Fig. 20 Typ. peak forward voltage V_{FR} and t_{tr} versus di_F/dt

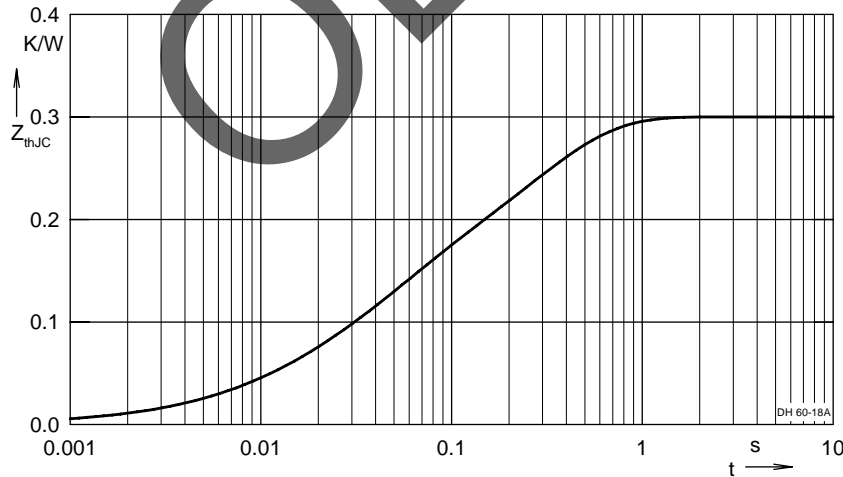

Fig. 21 Transient thermal resistance junction to case

IXYS reserves the right to change limits, test conditions, and dimensions.

Note: Fig. 16 to Fig. 20 shows typical values



Disclaimer Notice - Information furnished is believed to be accurate and reliable. However, users should independently evaluate the suitability of and test each product selected for their own applications. Littelfuse products are not designed for, and may not be used in, all applications. Read complete Disclaimer Notice at www.littelfuse.com/disclaimer-electronics.