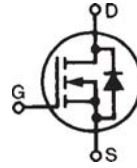

**Depletion Mode  
MOSFET**
**IXTH16N10D2  
IXTT16N10D2**

$$V_{DSX} = 100V$$

$$I_{D(on)} \geq 16A$$

$$R_{DS(on)} \leq 64m\Omega$$

**N-Channel**

Symbol	Test Conditions	Maximum Ratings	
$V_{DSX}$	$T_J = 25^\circ C$ to $150^\circ C$	100	V
$V_{DGX}$	$T_J = 25^\circ C$ to $150^\circ C$ , $R_{GS} = 1M\Omega$	100	V
$V_{GSX}$	Continuous	$\pm 20$	V
$V_{GSM}$	Transient	$\pm 30$	V
$P_D$	$T_C = 25^\circ C$	695	W
$T_J$		- 55 ... +150	$^\circ C$
$T_{JM}$		150	$^\circ C$
$T_{stg}$		- 55 ... +150	$^\circ C$
$T_L$	1.6mm (0.062 in.) from Case for 10s	300	$^\circ C$
$T_{SOLD}$	Plastic Body for 10s	260	$^\circ C$
$M_d$	Mounting Torque (TO-247)	1.13 / 10	Nm/lb.in.
Weight	TO-247	6	g
	TO-268	4	g

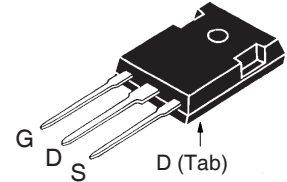
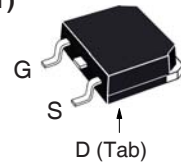
**TO-247 (IXTH)**

**TO-268 (IXTT)**

G = Gate      D = Drain  
S = Source    Tab = Drain

**Features**

- Normally ON Mode
- International Standard Packages
- Molding Epoxies Meet UL94 V-0 Flammability Classification

**Advantages**

- Easy to Mount
- Space Savings
- High Power Density

**Applications**

- Audio Amplifiers
- Start-up Circuits
- Protection Circuits
- Ramp Generators
- Current Regulators
- Active Loads

Symbol	Test Conditions ( $T_J = 25^\circ C$ , Unless Otherwise Specified)	Characteristic Values		
		Min.	Typ.	Max.
$BV_{DSX}$	$V_{GS} = -5V$ , $I_D = 250\mu A$	100		V
$V_{GS(off)}$	$V_{DS} = 25V$ , $I_D = 1mA$	- 2.0		V
$I_{GSX}$	$V_{GS} = \pm 20V$ , $V_{DS} = 0V$			$\pm 100$ nA
$I_{DSX(off)}$	$V_{DS} = V_{DSX}$ , $V_{GS} = -5V$ $T_J = 125^\circ C$			5 $\mu A$ 75 $\mu A$
$R_{DS(on)}$	$V_{GS} = 0V$ , $I_D = 8A$ , Note 1			64 m $\Omega$
$I_{D(on)}$	$V_{GS} = 0V$ , $V_{DS} = 25V$ , Note 1	16		A

Symbol	Test Conditions ( $T_J = 25^\circ\text{C}$ , Unless Otherwise Specified)	Characteristic Values		
		Min.	Typ.	Max.
$g_{fs}$	$V_{DS} = 20\text{V}, I_D = 8\text{A}$ , Note 1	7	11	S
$C_{iss}$	$V_{GS} = -10\text{V}, V_{DS} = 25\text{V}, f = 1\text{MHz}$		5700	pF
$C_{oss}$			1980	pF
$C_{rss}$			940	pF
$t_{d(on)}$	<b>Resistive Switching Times</b> $V_{GS} = \pm 5\text{V}, V_{DS} = 50\text{V}, I_D = 8\text{A}$ $R_G = 3.3\Omega$ (External)		45	ns
$t_r$			43	ns
$t_{d(off)}$			340	ns
$t_f$			70	ns
$Q_{g(on)}$	$V_{GS} = \pm 5\text{V}, V_{DS} = 50\text{V}, I_D = 8\text{A}$		225	nC
$Q_{gs}$			22	nC
$Q_{gd}$			126	nC
$R_{thJC}$			0.18	$^\circ\text{C/W}$
$R_{thCS}$		0.21		$^\circ\text{C/W}$

### Safe-Operating-Area Specification

Symbol	Test Conditions	Characteristic Values		
		Min.	Typ.	Max.
SOA	$V_{DS} = 100\text{V}, I_D = 4.2\text{A}, T_C = 75^\circ\text{C}, t_p = 5\text{s}$	420		W

### Source-Drain Diode

Symbol	Test Conditions ( $T_J = 25^\circ\text{C}$ , Unless Otherwise Specified)	Characteristic Values		
		Min.	Typ.	Max.
$V_{SD}$	$I_F = 16\text{A}, V_{GS} = -10\text{V}$ , Note 1		0.80	1.30 V
$t_{rr}$	$I_F = 8\text{A}, -di/dt = 100\text{A}/\mu\text{s}$ $V_R = 100\text{V}, V_{GS} = -10\text{V}$		205	ns
$I_{RM}$			8.50	A
$Q_{RM}$			0.88	$\mu\text{C}$

Note 1. Pulse test,  $t \leq 300\mu\text{s}$ , duty cycle,  $d \leq 2\%$ .

### ADVANCE TECHNICAL INFORMATION

The product presented herein is under development. The Technical Specifications offered are derived from a subjective evaluation of the design, based upon prior knowledge and experience, and constitute a "considered reflection" of the anticipated result. IXYS reserves the right to change limits, test conditions, and dimensions without notice.

IXYS Reserves the Right to Change Limits, Test Conditions, and Dimensions.

IXYS MOSFETs and IGBTs are covered 4,835,592 4,931,844 5,049,961 5,237,481 6,162,665 6,404,065 B1 6,683,344 6,727,585 7,005,734 B2 7,157,338B2  
by one or more of the following U.S. patents: 4,850,072 5,017,508 5,063,307 5,381,025 6,259,123 B1 6,534,343 6,710,405 B2 6,759,692 7,063,975 B2  
4,881,106 5,034,796 5,187,117 5,486,715 6,306,728 B1 6,583,505 6,710,463 6,771,478 B2 7,071,537

### TO-247 (IXTH) Outline

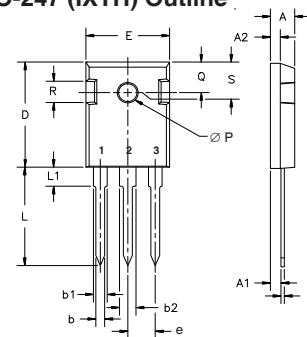

Terminals: 1 - Gate 2 - Drain  
3 - Source

Dim.	Millimeter		Inches	
	Min.	Max.	Min.	Max.
A	4.7	5.3	.185	.209
A <sub>1</sub>	2.2	2.54	.087	.102
A <sub>2</sub>	2.2	2.6	.059	.098
b	1.0	1.4	.040	.055
b <sub>1</sub>	1.65	2.13	.065	.084
b <sub>2</sub>	2.87	3.12	.113	.123
C	.4	.8	.016	.031
D	20.80	21.46	.819	.845
E	15.75	16.26	.610	.640
e	5.20	5.72	0.205	0.225
L	19.81	20.32	.780	.800
L <sub>1</sub>		4.50		.177
∅P	3.55	3.65	.140	.144
Q	5.89	6.40	0.232	0.252
R	4.32	5.49	.170	.216
S	6.15	BSC	242	BSC

### TO-268 (IXTT) Outline

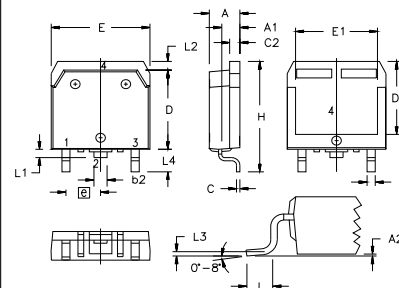

Terminals: 1 - Gate 2 - Drain  
3 - Source Tab - Drain

SYM	INCHES		MILLIMETERS	
	MIN	MAX	MIN	MAX
A	.193	.201	4.90	5.10
A <sub>1</sub>	.106	.114	2.70	2.90
A <sub>2</sub>	.001	.010	0.02	0.25
b	.045	.057	1.15	1.45
b <sub>2</sub>	.075	.083	1.90	2.10
C	.016	.026	0.40	0.65
C <sub>2</sub>	.057	.063	1.45	1.60
D	.543	.551	13.80	14.00
D <sub>1</sub>	.488	.500	12.40	12.70
E	.624	.632	15.85	16.05
E <sub>1</sub>	.524	.535	13.30	13.60
e	.215	BSC	5.45	BSC
H	.736	.752	18.70	19.10
L	.094	.106	2.40	2.70
L <sub>1</sub>	.047	.055	1.20	1.40
L <sub>2</sub>	.039	.045	1.00	1.15
L <sub>3</sub>	.010	BSC	0.25	BSC
L <sub>4</sub>	.150	.161	3.80	4.10

Fig. 1. Output Characteristics @  $T_J = 25^\circ\text{C}$

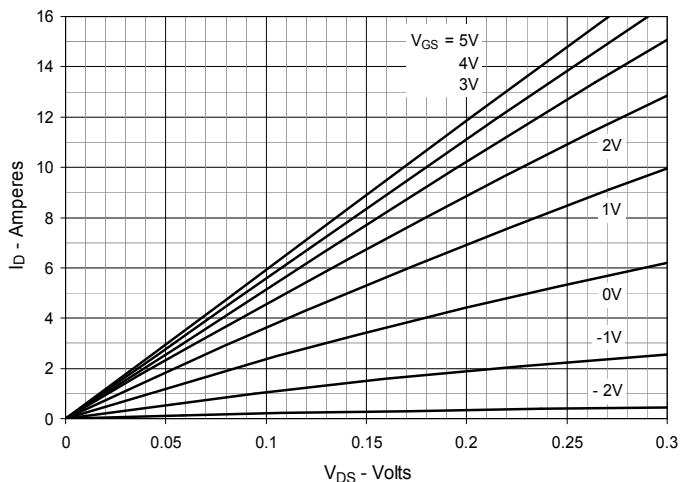

Fig. 2. Extended Output Characteristics @  $T_J = 25^\circ\text{C}$

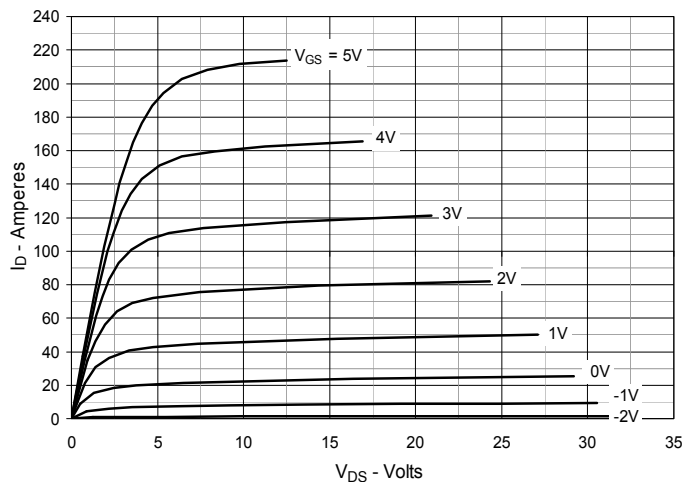

Fig. 3. Output Characteristics @  $T_J = 125^\circ\text{C}$

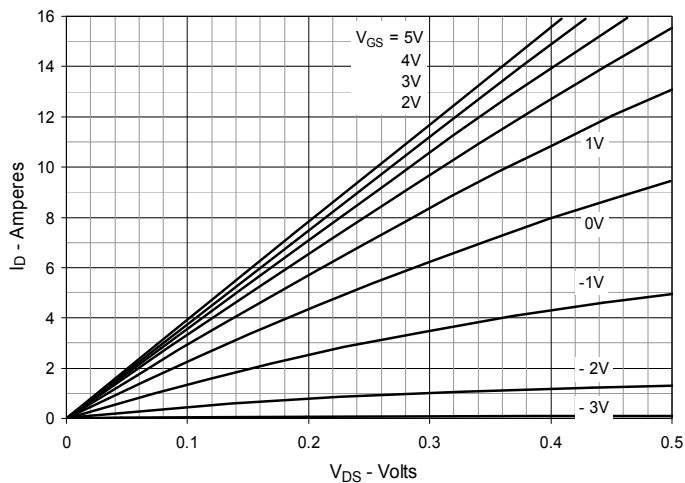

Fig. 4. Drain Current @  $T_J = 25^\circ\text{C}$

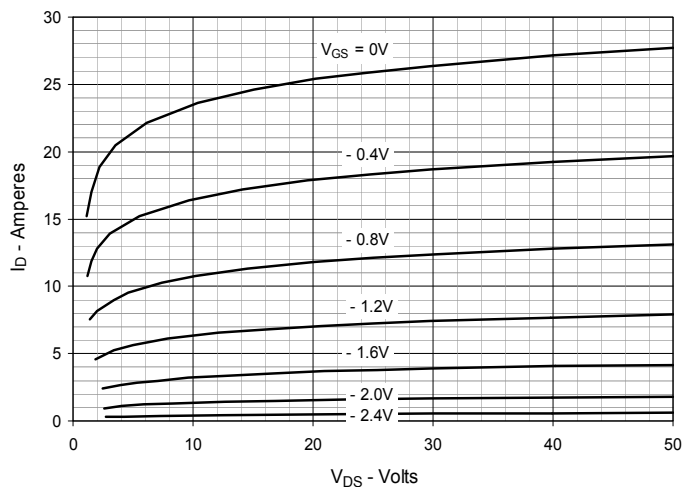

Fig. 5. Drain Current @  $T_J = 100^\circ\text{C}$

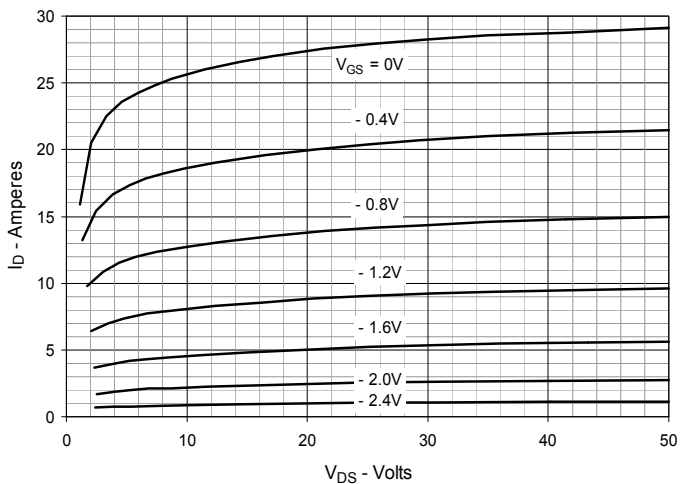
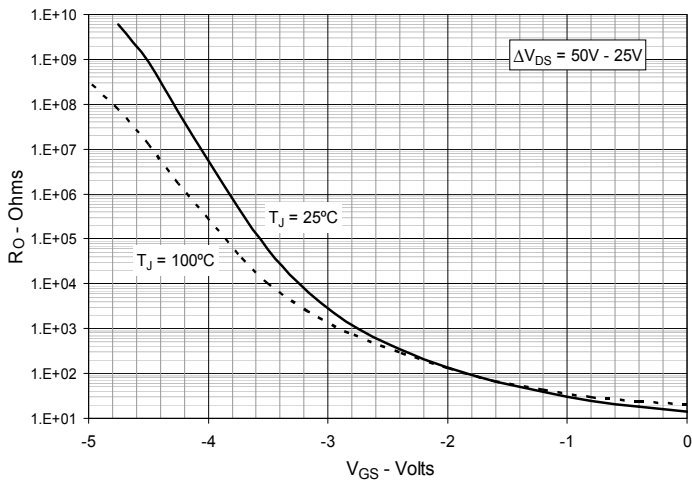
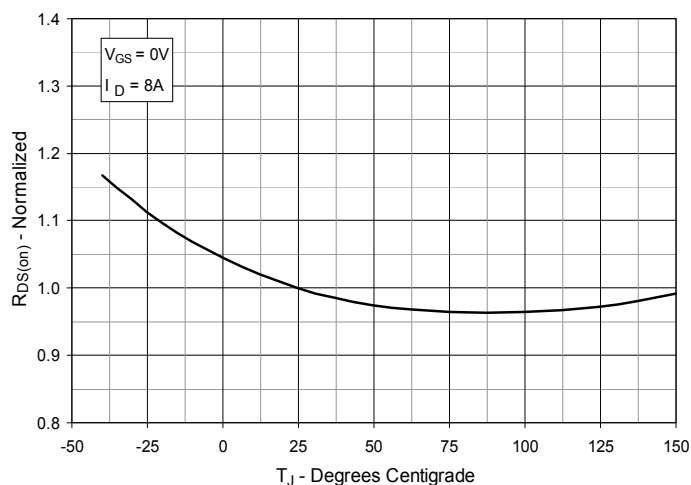

Fig. 6. Dynamic Resistance vs. Gate Voltage



**Fig. 7. Normalized  $R_{DS(on)}$  vs. Junction Temperature**



**Fig. 8.  $R_{DS(on)}$  Normalized to  $I_D = 8A$  Value vs. Drain Current**

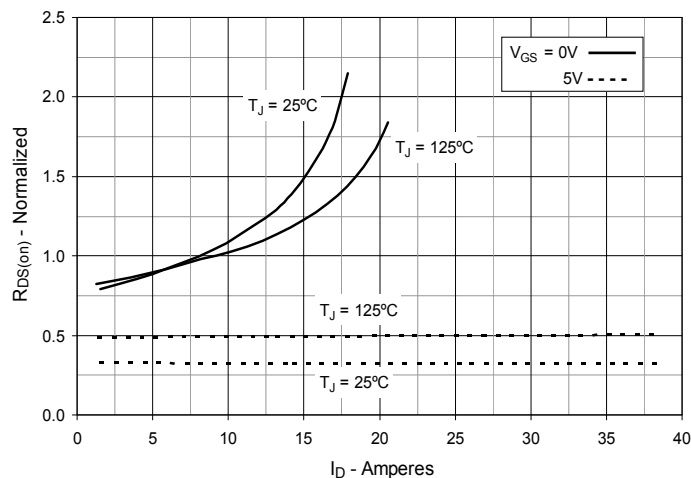

**Fig. 9. Input Admittance**

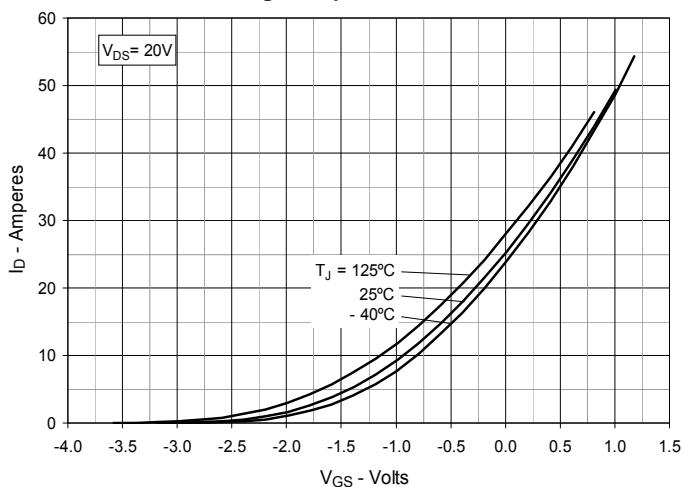

**Fig. 10. Transconductance**

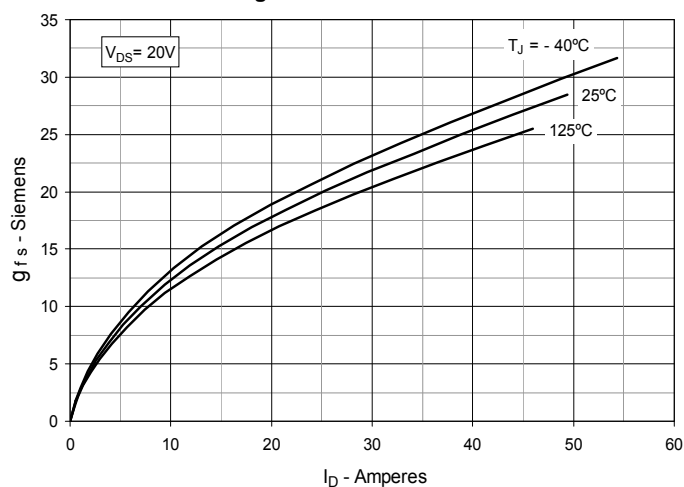

**Fig. 11. Normalized Breakdown and Threshold Voltages vs. Junction Temperature**

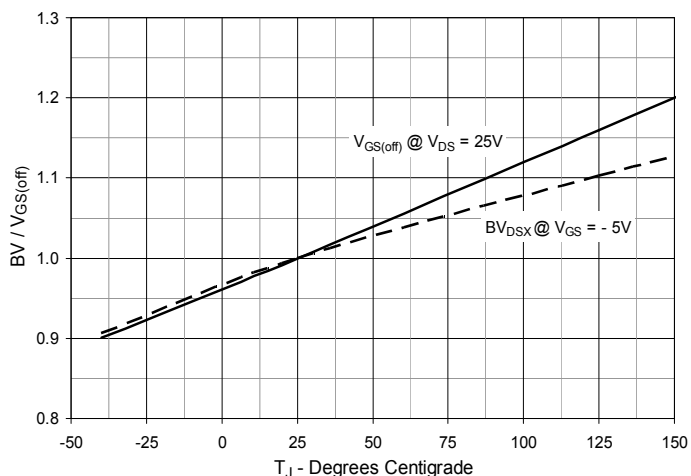

**Fig. 12. Forward Voltage Drop of Intrinsic Diode**

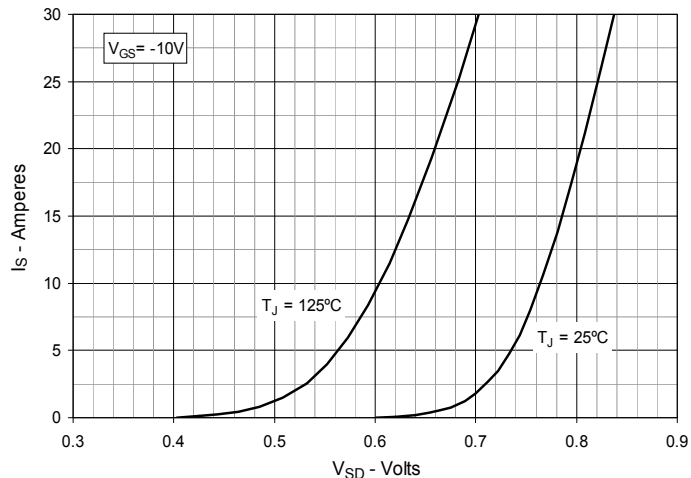

**Fig. 13. Capacitance**

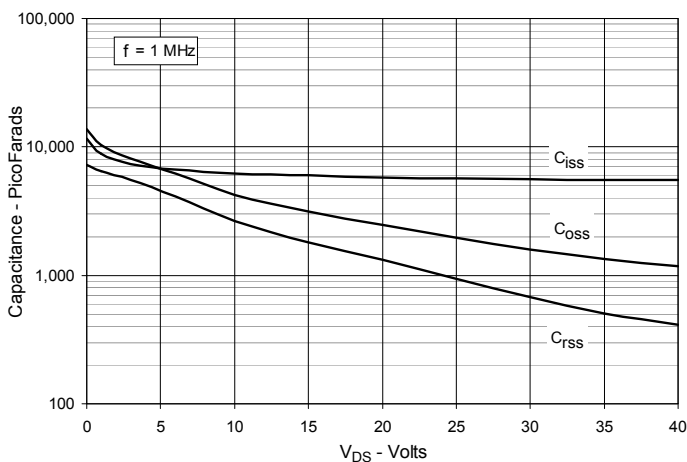

**Fig. 14. Gate Charge**

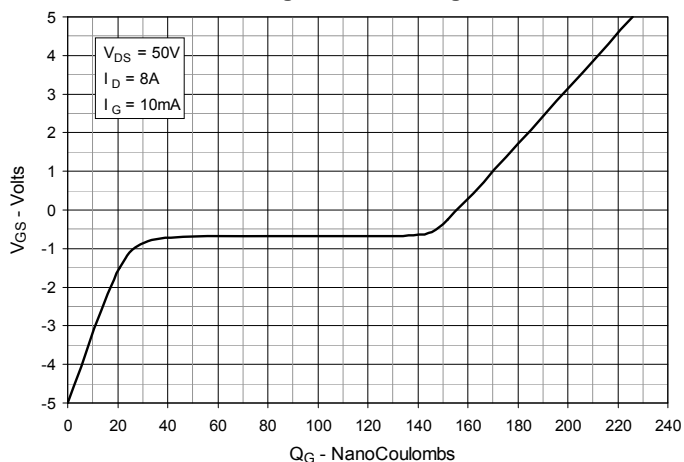

**Fig. 15. Forward-Bias Safe Operating Area  
@  $T_C = 25^\circ\text{C}$**

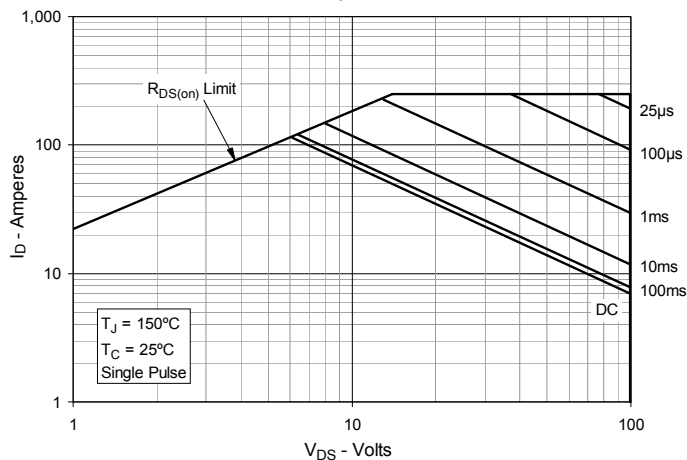

**Fig. 16. Forward-Bias Safe Operating Area  
@  $T_C = 75^\circ\text{C}$**

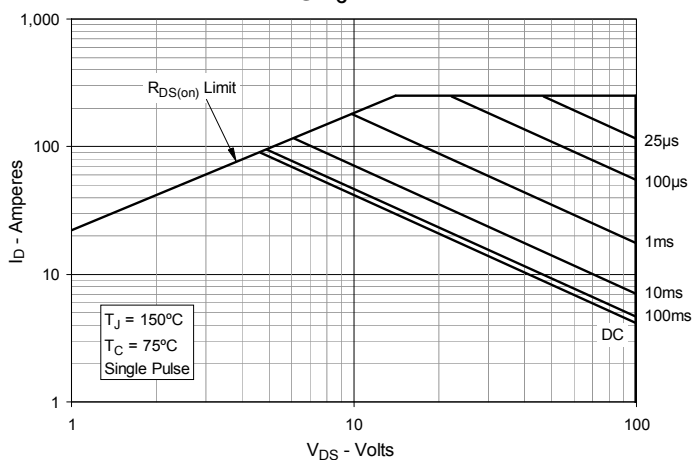

**Fig. 17. Maximum Transient Thermal Impedance**

