

MegaMOS FETs

T-39-15

The MegaMOS family of large scale monolithic Power MOSFETs provides significantly higher power handling capability than industry standard MOSFETs. With HDMOS technology, IXYS has increased its chip sizes without a major cost penalty to the user. Unlike the popular size 3, 4 and 5 MOSFETs, IXYS size 6 and 7 MegaMOS MOSFETs are 50% larger in silicon area. These FETs provide two times the ruggedness to unclamped inductive energy and dv/dt while eliminating the complexities and safeguards needed when paralleling smaller MOSFETs.

Lower $R_{DS(ON)}$ and R_{thJC} In The Same Package

Although IXYS MegaMOS FETs are 50% larger, they fit in both the TO-204 (TO-3) and TO-247 industry standard packages. Compared with other MOSFETs, they have half the on-resistance across the voltage spectrum from 80 to 1000 volts. Our size 7 die which has a thermal resistance rating of $0.42^{\circ}\text{C}/\text{watt}$, is capable of handling twice the power of industry standard size 5 MOSFETs. These combined advantages allow for higher current handling and lower power dissipation without requiring a mechanical redesign. They are ideal for off-line forward and flyback converters, vertical and horizontal deflection circuits, radar modular circuits, military power supplies as well as other applications requiring very high voltage.

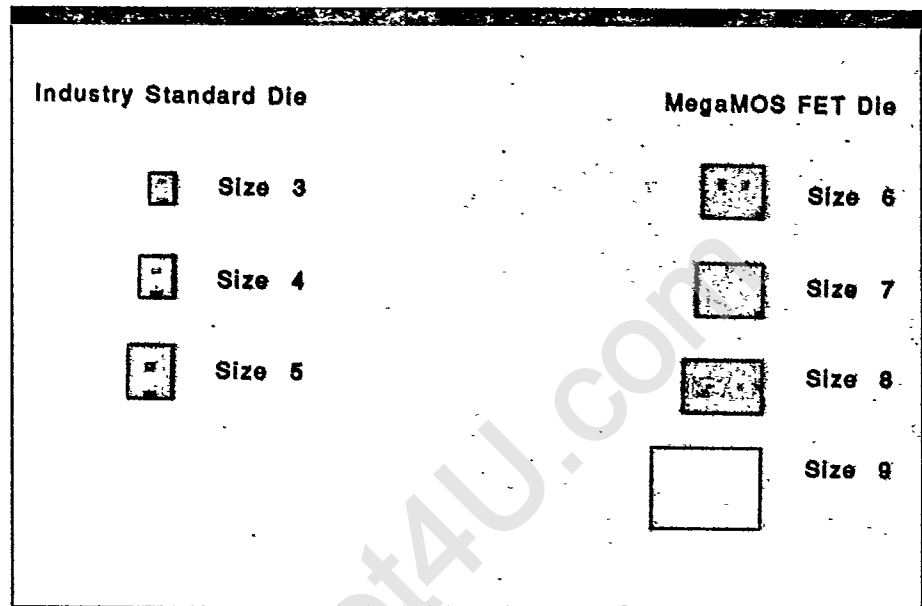

Low C_{iss} and High Transconductance

HDMOS' unique cell design and process improvements contribute to the MegaMOS family having 50% higher transconductance levels per unit area than competitive designs. They also have input capacitance and reverse transfer capacitance values which are much less than when paralleling two smaller MOSFETs to achieve the same power rating. The designer can simply "plug-in" the MegaMOS FET to get higher power without a major gate circuit redesign.



New Isolated Hi-Rel and Commercial Packages

IXYS supplies its MegaMOS family in a number of standard packages with internal isolation for ease of mount-down and higher current handling. MegaMOS FETs are available in the Hi-Rel TO-254 and TO-61 as well as the innovative IXYS "Z-Pac." For commercial applications, the MegaMOS family is available in the rugged TO-238 isolated package, giving IXYS the highest current and power rating available in a single discrete cost-effective package.

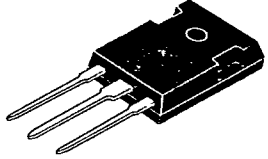
MegaMOS Power MOSFETs

Part Number	Drain-Source Voltage $V_{(BR)DSS}$ (Volts)	Drain Current I_D @ 25 °C Case		On Resistance $R_{DS(on)}$ (Ohms)	Input Cap. C_{iss} (pF)	Power Diss. P_D Max (Watts)	Notes	Case Style
		$I_{D(Cont)}$ (Amps)	$I_{D(Pulsed)}$ (Amps)					
IXTH12N100	1000	12	48	1.0	4500	300		TO-247 
IXTH11N100	1000	11	44	1.15	4500	300		
IXTH10N100	1000	10	40	1.2	4200	250		
IXTH9N100	1000	9	36	1.4	4200	250		
IXTH12N95	950	12	48	1.0	4500	300		
IXTH11N95	950	11	44	1.15	4500	300		
IXTH10N95	950	10	40	1.2	4200	250		
IXTH9N95	950	9	36	1.4	4200	250		
IXTH13N90	900	13	52	0.8	4500	300		
IXTH12N90	900	12	48	0.9	4500	300		
IXTH11N90	900	11	44	0.95	4200	250		
IXTH10N90	900	10	40	1.1	4200	250		
IXTH13N80	800	13	52	0.8	4500	300		
IXTH12N80	800	12	48	0.9	4500	300		
IXTH11N80	800	11	44	0.95	4200	250		
IXTH10N80	800	10	40	1.1	4200	250		
IXTH18N65	650	18	72	0.4	4500	300		
IXTH17N65	650	17	68	0.45	4500	300		
IXTH15N65	650	15	60	0.5	4200	250		
IXTH13N65	650	13	52	0.65	4200	250		
IXTH21N60	600	21	84	0.3	4500	300		
IXTH20N60	600	20	80	0.35	4500	300		
IXTH17N60	600	17	68	0.4	4200	250		
IXTH15N60	600	15	60	0.5	4200	250		
IXTH21N55	550	21	84	0.3	4500	300		
IXTH20N55	550	20	80	0.35	4500	300		
IXTH17N55	550	17	68	0.4	4200	250		
IXTH15N55	550	15	60	0.5	4200	250		
IXTH26N50	500	26	104	0.2	4500	300		
IXTH24N50	500	24	96	0.23	4500	300		
IXTH21N50	500	21	84	0.25	4200	250		
IXTH19N50	500	19	76	0.3	4200	250		
IXTH26N45	450	26	104	0.2	4500	300		
IXTH24N45	450	24	96	0.23	4500	300		
IXTH21N45	450	21	84	0.25	4200	250		
IXTH19N45	450	19	76	0.3	4200	250		
IXTH40N30	300	40	160	0.08	4200	250		
IXTH35N30	300	35	140	0.1	4200	250		
IXTH40N25	250	40	160	0.08	4200	250		
IXTH35N25	250	35	140	0.1	4200	250		
IXTH50N20	200	50	200	0.045	4200	250		
IXTH42N20	200	42	200	0.065	4200	250		
IXTH50N15	150	50	200	0.045	4200	250		
IXTH42N15	150	42	200	0.065	4200	250		
IXTH75N10	100	75	300	0.02	4200	250		
IXTH67N10	100	67	268	0.025	4200	250		
IXTH75N08	80	75	300	0.02	4200	250		
IXTH67N08	80	67	268	0.025	4200	250		

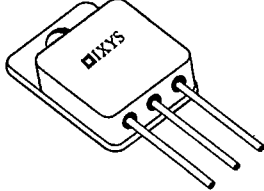
MegaMOS Power MOSFETs

Part Number	Drain-Source Voltage $V_{(BR)DSS}$ (Volts)	Drain Current I_D @ 25 °C Case		On Resistance $R_{DS(on)}$ (Ohms)	Input Cap. C_{iss} (pF)	Power Diss. P_D Max (Watts)	Notes	Case Style
		$I_{D(Cont)}$ (Amps)	$I_{D(Pulse)}$ (Amps)					
IXTL13N65	650	13	52	0.5	4200	175		TO-254 
IXTL14N60	600	14	56	0.4	4200	175		
IXTL18N50	500	18	72	0.25	4200	175		
IXTL24N40	400	24	96	0.2	4200	175		
IXTL25N20	200	25	100	0.065	4200	175		
IXTL25N10	100	25	100	0.030	4200	175		
IXTM12N100	1000	12	48	1.0	4500	300		TO-204 (TO-3) 
IXTM11N100	1000	11	44	1.15	4500	300		
IXTM10N100	1000	10	40	1.2	4200	250		
IXTM9N100	1000	9	36	1.4	4200	250		
IXTM12N95	950	12	48	1.0	4500	300		
IXTM11N95	950	11	44	1.15	4500	300		
IXTM10N95	950	10	40	1.2	4200	250		
IXTM9N95	950	9	36	1.4	4200	250		
IXTM13N90	900	13	52	0.8	4500	300		
IXTM12N90	900	12	48	0.9	4500	300		
IXTM11N90	900	11	44	0.95	4200	250		
IXTM10N90	900	10	40	1.1	4200	250		
IXTM13N80	800	13	52	0.8	4500	300		
IXTM12N80	800	12	48	0.9	4500	300		
IXTM11N80	800	11	44	0.95	4200	250		
IXTM10N80	800	10	40	1.1	4200	250		
IXTM18N65	650	18	72	0.4	4500	300		
IXTM17N65	650	17	68	0.45	4500	300		
IXTM15N65	650	15	60	0.5	4200	250		
IXTM13N65	650	13	52	0.65	4200	250		
IXTM21N60	600	21	84	0.3	4500	300		
IXTM20N60	600	20	80	0.35	4500	300		
IXTM17N60	600	17	68	0.4	4200	250		
IXTM15N60	600	15	60	0.5	4200	250		
IXTM21N55	550	21	84	0.3	4500	300		
IXTM20N55	550	20	80	0.35	4500	300		
IXTM17N55	550	17	68	0.4	4200	250		
IXTM15N55	550	15	60	0.5	4200	250		
IXTM26N50	500	26	104	0.2	4500	300		
IXTM24N50	500	24	96	0.23	4500	300		
IXTM21N50	500	21	84	0.25	4200	250		
IXTM19N50	500	19	76	0.3	4200	250		
IXTM26N45	450	26	104	0.2	4500	300		
IXTM24N45	450	24	96	0.23	4500	300		
IXTM21N45	450	21	84	0.25	4200	250		
IXTM19N45	450	19	76	0.3	4200	250		

MegaMOS Power MOSFETs

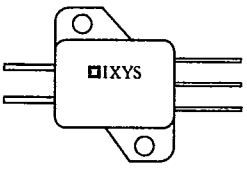
Part Number	Drain-Source Voltage $V_{(BR)DSS}$ (Volts)	Drain Current I_D @ 25 °C Case		On Resistance $R_{DS(on)}$ (Ohms)	Input Cap. C_{iss} (pF)	Power Diss. P_D Max (Watts)	Notes	Case Style
		$I_{D(Cont)}$ (Amps)	$I_{D(Pulsed)}$ (Amps)					
IXTM40N30	300	40	160	0.08	4200	250		TO-204 (TO-3) 
IXTM35N30	300	35	140	0.1	4200	250		
IXTM40N25	250	40	160	0.08	4200	250		
IXTM35N25	250	35	140	0.1	4200	250		
IXTM50N20	200	50	200	0.045	4200	250		
IXTM42N20	200	42	200	0.065	4200	250		
IXTM50N15	150	50	200	0.045	4200	250		
IXTM42N15	150	42	200	0.065	4200	250		
IXTM75N10	100	75	300	0.02	4200	250		
IXTM67N10	100	67	268	0.025	4200	250		
IXTM75N08	80	75	300	0.02	4200	250		
IXTM67N08	80	67	268	0.025	4200	250		
IXTS12N65	650	12	48	0.5	4200	175		
IXTS13N60	600	13	52	0.4	4200	175		
IXTS17N50	500	17	68	0.25	4200	175		
IXTZ11N100	1000	11	44	1.15	4500	300		Z-Pac 
IXTZ12N90	900	12	48	0.9	4500	300		
IXTZ18N65	650	18	72	0.4	4500	300		
IXTZ21N60	600	21	84	0.3	4500	300		
IXTZ24N50	500	24	96	0.23	4500	300		
IXTZ35N30	300	35	140	0.1	4200	250		
IXTZ42N20	200	42	168	0.065	4200	250		
IXTZ67N10	100	67	268	0.025	4200	250		

DETAILED PACKAGE OUTLINES

T-91-20

TO-220 AB

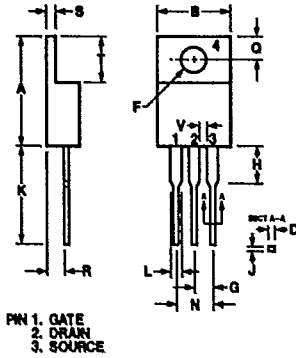

Dim.	Millimeter		Inches	
	Min.	Max.	Min.	Max.
A	14.23	16.51	.560	.650
B	9.66	10.66	.380	.420
C	3.56	4.82	.140	.190
D	0.64	0.89	.025	.035
F	3.54	4.08	.139	.161
G	2.29	2.79	.090	.110
H	-	6.35	-	.250
J	0.51	.76	.020	.030
K	12.70	14.73	.500	.580
L	1.15	1.77	.045	.070
N	4.83	5.33	.190	.210
Q	2.54	3.42	.100	.135
R	2.04	2.49	.080	.115
S	0.64	1.39	.025	.055
T	5.95	6.85	.230	.270
V	1.15	-	.045	-

CONFORMS TO OUTLINE TO-220 (IR H-7) Dimensions in Millimeters (Inches)

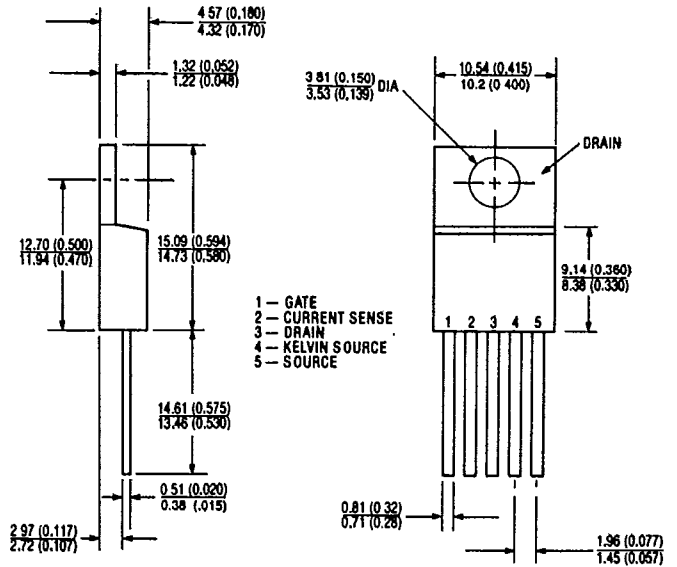

TO-247 (3 LEADED)

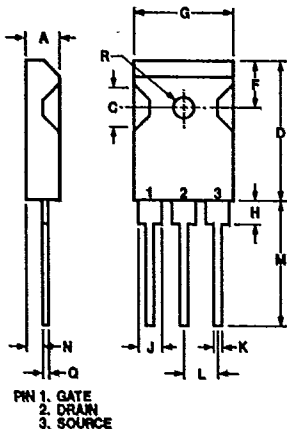

Dim.	Millimeter		Inches	
	Min.	Max.	Min.	Max.
A	4.7	5.3	.185	.209
C	4.5	6.0	.178	.236
D	19.7	21.4	.776	.843
F	5.3	6.1	.209	.240
G	15.3	15.9	.602	.625
H	3.7	4.3	.146	.169
J	1.95	2.4	.077	.094
J ₁	2.97	3.4	.117	.134
K	1.0	1.4	.040	.055
L	5.4	5.5	.213	.217
M	19.9	20.2	.783	.795
N	2.2	2.6	.087	.102
Q	0.4	0.8	.016	.031
R	2.9	3.3	.114	.129

TO-247 (5 LEADED)

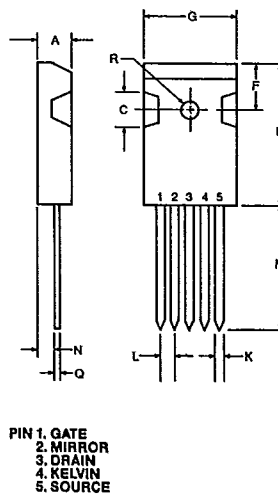

Dim.	Millimeter		Inches	
	Min.	Max.	Min.	Max.
A	4.7	5.3	.185	.209
C	4.5	6.0	.178	.236
D	19.7	21.4	.776	.843
F	5.3	6.1	.209	.240
G	15.3	15.9	.602	.625
K	1.1	1.3	.043	.051
L	2.51	2.56	.099	.101
M	19.9	20.2	.783	.795
N	2.2	2.6	.087	.102
Q	0.4	0.8	.016	.031
R	2.9	3.3	.114	.129

TO-238
Dimensions in Millimeters

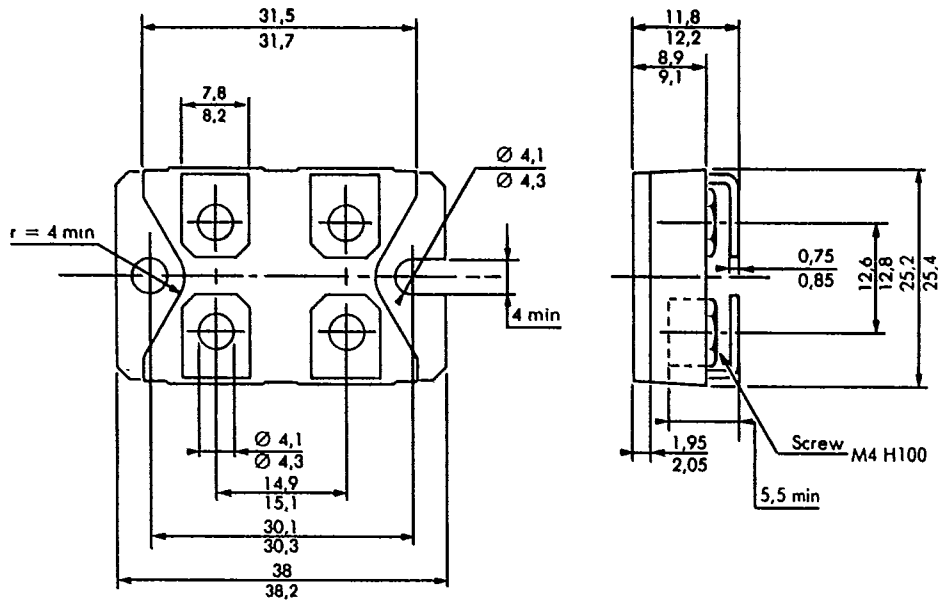

Y-4
Dimensions in Millimeters

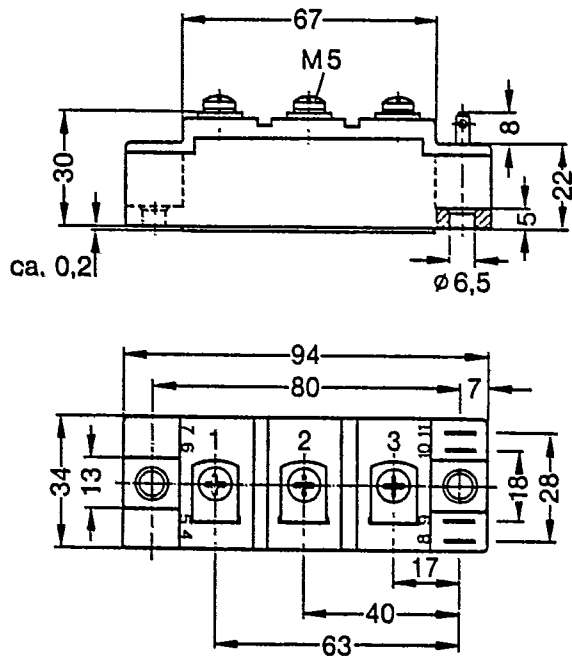

Y-3
Dimensions in Millimeters

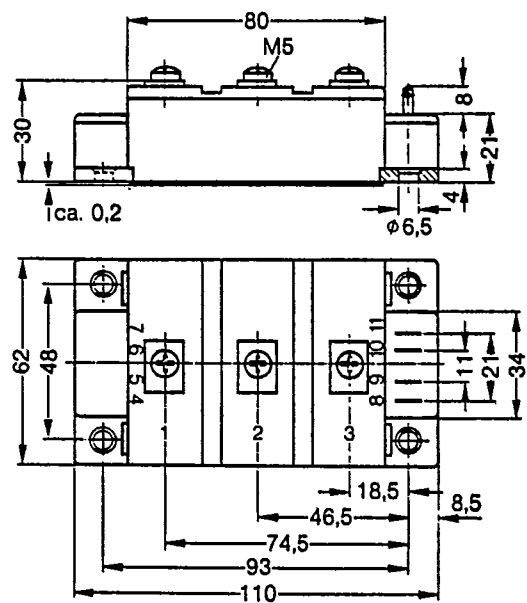

TO-220 HERMETIC

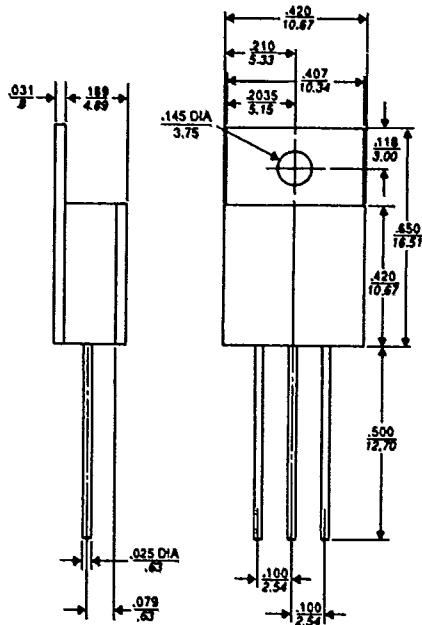

TO-204 AE

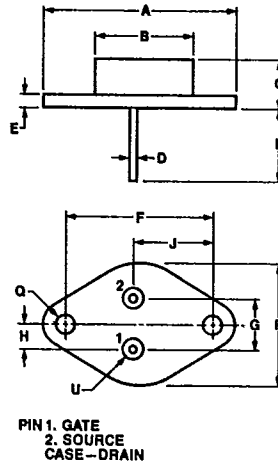

Dim.	Millimeter	Max.	Inches	Max.
A	—	39.37	—	1.55
B	—	19.71	—	.776
C	7.62	10.16	.300	.400
D	1.47	1.57	.058	.062
E	1.52	3.43	.060	.135
F	30.15	BSC	1.187	BSC
G	10.67	11.18	.420	.440
H	5.33	6.10	.210	.240
J	16.68	17.12	.657	.674
K	11.20	11.98	.441	.472
Q	3.86	4.11	.152	.162
R	24.84	25.27	.978	.995

TO-204 AA

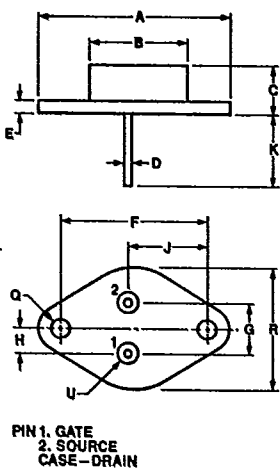

Dim.	Millimeter	Max.	Inches	Max.
A	—	39.37	—	.155
B	—	19.71	—	.776
C	6.35	8.89	.250	.350
D	.097	1.09	.038	.043
E	—	3.43	—	.135
F	30.15	BSC	1.187	BSC
G	10.67	11.18	.420	.440
H	5.33	6.10	.210	.240
J	16.68	17.12	.657	.674
K	11.20	11.98	.441	.472
Q	3.86	4.11	.152	.162
R	24.84	25.47	.978	1.00

TO-254 HERMETIC

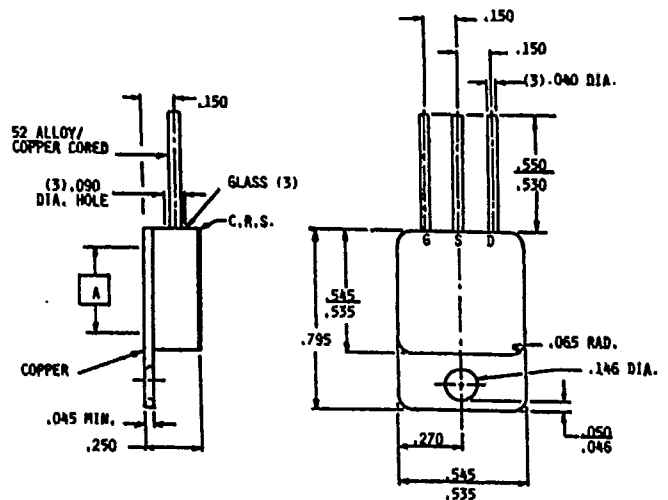

CONFORMS TO JEDEC OUTLINE TO-210AC (TO-61)
 Dimensions in Millimeters (Inches)

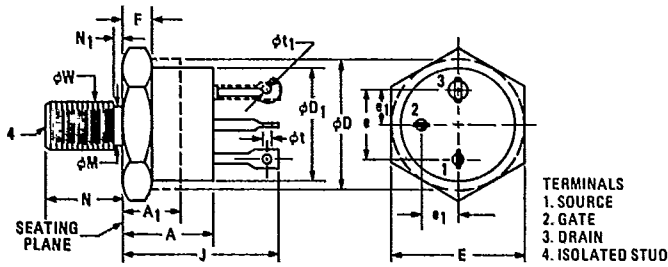

TERMINALS
 1. SOURCE
 2. GATE
 3. DRAIN
 4. ISOLATED STUD

Symbol	Inches		Millimeters		Notes
	Min.	Max.	Min.	Max.	
A	0.325	0.450	8.26	11.68	
A ₁	0.270	0.270	6.86	6.86	2
ϕD	0.610	0.687	15.49	17.45	2
ϕD_1	0.570	0.610	14.48	15.49	
E	0.667	0.667	16.94	17.45	
e	0.340	0.415	8.64	10.54	5
e ₁	0.170	0.213	4.32	5.41	5
F	0.090	0.150	2.29	3.81	1

Symbol	Inches		Millimeters		Notes
	Min.	Max.	Min.	Max.	
J	0.640	0.875	16.26	22.23	
ϕM	0.220	0.249	5.59	6.32	
N	0.422	0.455	10.72	11.56	
N ₁		0.090		2.29	
ϕt	0.055	0.072	1.19	1.83	
ϕt_1	0.046	0.077	1.17	1.96	4
ϕW	0.2225	0.2768	5.661	5.761	3

NOTES

1. DIMENSION DOES NOT INCLUDE SEALING FLANGES.
2. PACKAGE CONTOUR OPTIONAL WITHIN DIMENSIONS SPECIFIED.
3. PITCH DIAMETER - THREAD 1/4 28 UNF 2A (COATED).
 REFERENCE ISCREW THREAD STANDARDS FOR FEDERAL SERVICES - HANDBOOK H 281.
4. THIS TERMINAL CAN BE FLATTENED AND PIERCED OR HOOK TYPE.
5. POSITION OF LEADS IN RELATION TO THE HEXAGON IS NOT CONTROLLED.

QUADPAC

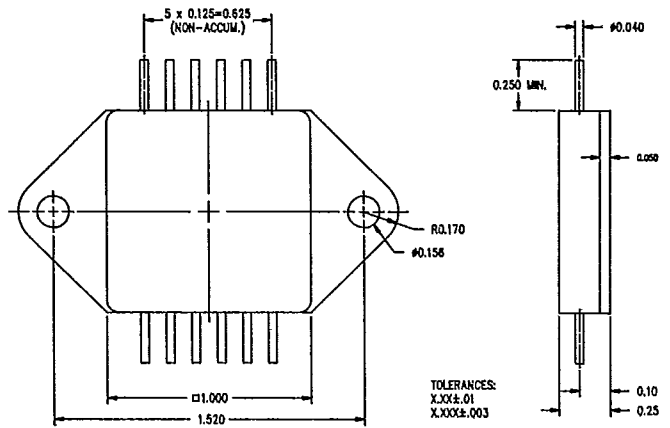

Z-Pac

