

# TrenchMV™ Power MOSFET

## IXTP50N085T IXTY50N085T

$$V_{DSS} = 85 \text{ V}$$

$$I_{D25} = 50 \text{ A}$$

$$R_{DS(on)} \leq 23 \text{ m}\Omega$$

N-Channel Enhancement Mode  
Avalanche Rated

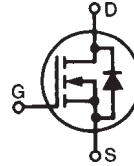

TO-220 (IXTP)

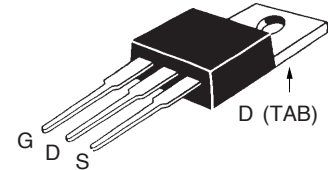

TO-252 (IXTY)

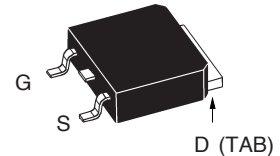

G = Gate                      D = Drain  
S = Source                    TAB = Drain

Symbol	Test Conditions	Maximum Ratings	
$V_{DSS}$	$T_J = 25^\circ\text{C}$ to $175^\circ\text{C}$	85	V
$V_{DGR}$	$T_J = 25^\circ\text{C}$ to $175^\circ\text{C}$ ; $R_{GS} = 1 \text{ M}\Omega$	85	V
$V_{GSM}$	Transient	$\pm 20$	V
$I_{D25}$	$T_C = 25^\circ\text{C}$	50	A
$I_L$	Package Current Limit, RMS	25	A
$I_{DM}$	$T_C = 25^\circ\text{C}$ , pulse width limited by $T_{JM}$	130	A
$I_{AR}$	$T_C = 25^\circ\text{C}$	10	A
$E_{AS}$	$T_C = 25^\circ\text{C}$	250	mJ
$dv/dt$	$I_S \leq I_{DM}$ , $di/dt \leq 100 \text{ A}/\mu\text{s}$ , $V_{DD} \leq V_{DSS}$ $T_J \leq 175^\circ\text{C}$ , $R_G = 18 \Omega$	3	V/ns
$P_D$	$T_C = 25^\circ\text{C}$	130	W
$T_J$		-55 ... +175	$^\circ\text{C}$
$T_{JM}$		175	$^\circ\text{C}$
$T_{stg}$		-55 ... +175	$^\circ\text{C}$
$T_L$	1.6 mm (0.062 in.) from case for 10 s	300	$^\circ\text{C}$
$T_{SOLD}$	Plastic body for 10 seconds	260	$^\circ\text{C}$
$M_d$	Mounting torque (TO-220)	1.13 / 10	Nm/lb.in.
Weight	TO-220	3	g
	TO-252	0.35	g

### Features

- Ultra-low On Resistance
- Unclamped Inductive Switching (UIS) rated
- Low package inductance
  - easy to drive and to protect
- 175  $^\circ\text{C}$  Operating Temperature

### Advantages

- Easy to mount
- Space savings
- High power density

### Applications

- Automotive
  - Motor Drives
  - 42V Power Bus
  - ABS Systems
- DC/DC Converters and Off-line UPS
- Primary Switch for 24V and 48V Systems
- High Current Switching Applications

Symbol	Test Conditions ( $T_J = 25^\circ\text{C}$ unless otherwise specified)	Characteristic Values		
		Min.	Typ.	Max.
$BV_{DSS}$	$V_{GS} = 0 \text{ V}$ , $I_D = 250 \mu\text{A}$	85		V
$V_{GS(th)}$	$V_{DS} = V_{GS}$ , $I_D = 25 \mu\text{A}$	2.0		4.0 V
$I_{GSS}$	$V_{GS} = \pm 20 \text{ V}$ , $V_{DS} = 0 \text{ V}$			$\pm 100 \text{ nA}$
$I_{DSS}$	$V_{DS} = V_{DSS}$			1 $\mu\text{A}$
	$V_{GS} = 0 \text{ V}$ $T_J = 150^\circ\text{C}$			100 $\mu\text{A}$
$R_{DS(on)}$	$V_{GS} = 10 \text{ V}$ , $I_D = 0.5 I_{D25}$ , Notes 1, 2			23 $\text{m}\Omega$

Symbol	Test Conditions ( $T_J = 25^\circ\text{C}$ unless otherwise specified)	Characteristic Values		
		Min.	Typ.	Max.
$g_{fs}$	$V_{DS} = 10\text{ V}; I_D = 0.5 I_{D25}$ , Note 1	18	29	S
$C_{iss}$	$V_{GS} = 0\text{ V}, V_{DS} = 25\text{ V}, f = 1\text{ MHz}$		1460	pF
$C_{oss}$			220	pF
$C_{rss}$			52	pF
$t_{d(on)}$	$V_{GS} = 10\text{ V}, V_{DS} = 0.5 V_{DSS}, I_D = 10\text{ A}$ $R_G = 18\ \Omega$ (External)		18	ns
$t_r$			32	ns
$t_{d(off)}$			38	ns
$t_f$			33	ns
$Q_{g(on)}$			34	nC
$Q_{gs}$	$V_{GS} = 10\text{ V}, V_{DS} = 0.5 V_{DSS}, I_D = 10\text{ A}$		10	nC
$Q_{gd}$			10	nC
$R_{thJC}$	TO-220			1.15 °C/W
$R_{thCS}$		0.5		°C/W

### Source-Drain Diode

Symbol	Test Conditions	Characteristic Values		
		Min.	Typ.	Max.
$T_J = 25^\circ\text{C}$ unless otherwise specified)				
$I_S$	$V_{GS} = 0\text{ V}$			50 A
$I_{SM}$	Repetitive			130 A
$V_{SD}$	$I_F = 25\text{ A}, V_{GS} = 0\text{ V}$ , Note 1			1.2 V
$t_{rr}$	$I_F = 25\text{ A}, -di/dt = 100\text{ A}/\mu\text{s}$ $V_R = 40\text{ V}, V_{GS} = 0\text{ V}$		55	ns

### TO-220 (IXTP) Outline

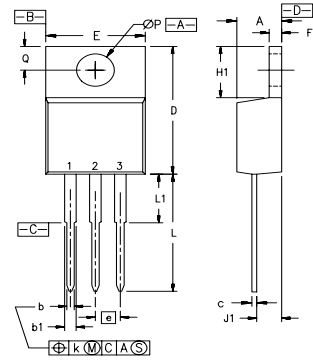

SYM	INCHES		MILLIMETERS	
	MIN	MAX	MIN	MAX
A	.170	.190	4.32	4.83
b	.025	.040	0.64	1.02
b1	.045	.065	1.15	1.65
c	.014	.022	0.35	0.56
D	.580	.630	14.73	16.00
E	.390	.420	9.91	10.66
e	.100 BSC		2.54 BSC	
F	.045	.055	1.14	1.40
H1	.230	.270	5.85	6.85
J1	.090	.110	2.29	2.79
k	0	.015	0	0.38
L	.500	.550	12.70	13.97
L1	.110	.230	2.79	5.84
ØP	.139	.161	3.53	4.08
Q	.100	.125	2.54	3.18

### Notes:

- Pulse test:  $t \leq 300\ \mu\text{s}$ , duty cycle  $d \leq 2\%$ ;
- On through-hole packages,  $R_{DS(on)}$  Kelvin test contact location must be 5 mm or less from the package body.

### TO-252 (IXTY) Outline

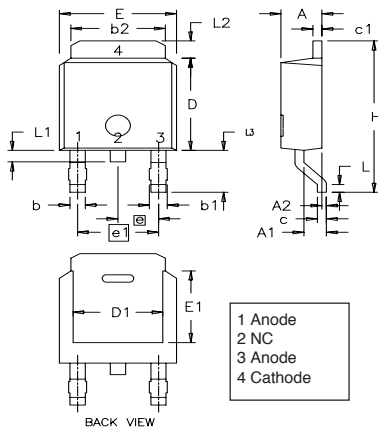

Dim.	Millimeter		Inches	
	Min.	Max.	Min.	Max.
A	2.19	2.38	0.086	0.094
A1	0.89	1.14	0.035	0.045
A2	0	0.13	0	0.005
b	0.64	0.89	0.025	0.035
b1	0.76	1.14	0.030	0.045
b2	5.21	5.46	0.205	0.215
c	0.46	0.58	0.018	0.023
c1	0.46	0.58	0.018	0.023
D	5.97	6.22	0.235	0.245
D1	4.32	5.21	0.170	0.205
E	6.35	6.73	0.250	0.265
E1	4.32	5.21	0.170	0.205
e	2.28 BSC		0.090 BSC	
e1	4.57 BSC		0.180 BSC	
H	9.40	10.42	0.370	0.410
L	0.51	1.02	0.020	0.040
L1	0.64	1.02	0.025	0.040
L2	0.89	1.27	0.035	0.050
L3	2.54	2.92	0.100	0.115

### PRELIMINARY TECHNICAL INFORMATION

The product presented herein is under development. The Technical Specifications offered are derived from data gathered during objective characterizations of preliminary engineering lots; but also may yet contain some information supplied during a pre-production design evaluation. IXYS reserves the right to change limits, test conditions, and dimensions without notice.

IXYS reserves the right to change limits, test conditions, and dimensions.

IXYS MOSFETs and IGBTs are covered by one or more of the following U.S. patents:	4,835,592	4,931,844	5,049,961	5,237,481	6,162,665	6,404,065 B1	6,683,344	6,727,585	7,005,734 B2
	4,850,072	5,017,508	5,063,307	5,381,025	6,259,123 B1	6,534,343	6,710,405 B2	6,759,692	7,063,975 B2
	4,881,106	5,034,796	5,187,117	5,486,715	6,306,728 B1	6,583,505	6,710,463	6,771,478 B2	7,071,537

**Fig. 1. Output Characteristics @ 25°C**

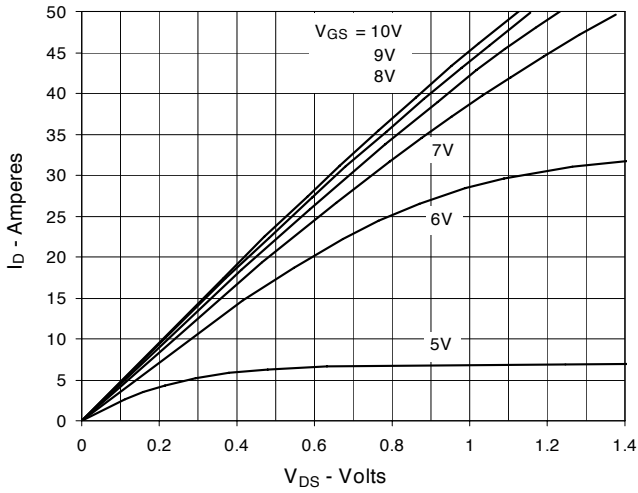

**Fig. 2. Extended Output Characteristics @ 25°C**

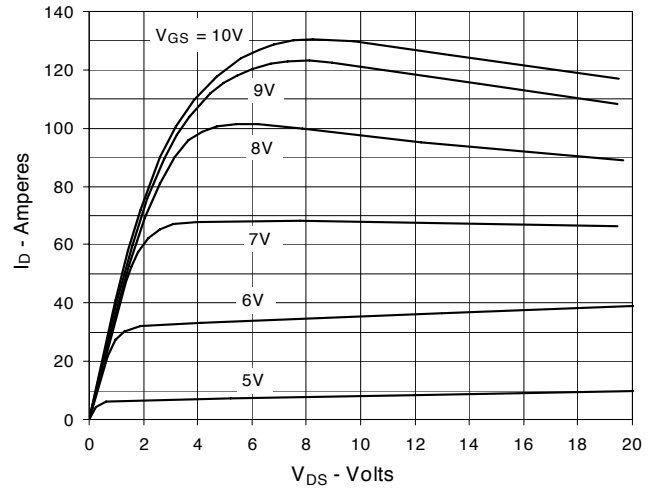

**Fig. 3. Output Characteristics @ 150°C**

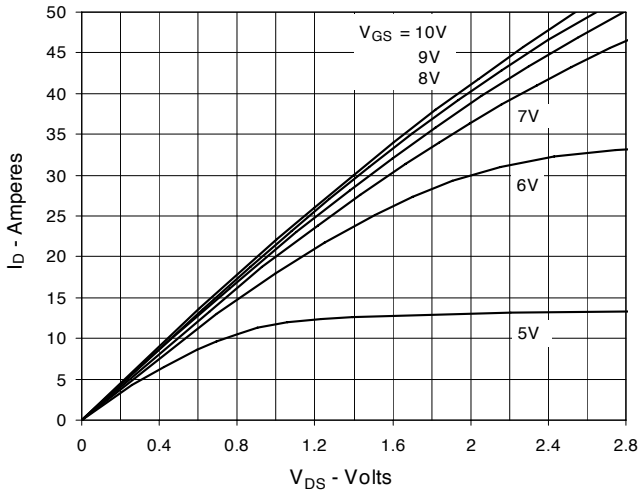

**Fig. 4.  $R_{DS(on)}$  Normalized to  $I_D = 25A$  Value vs. Junction Temperature**

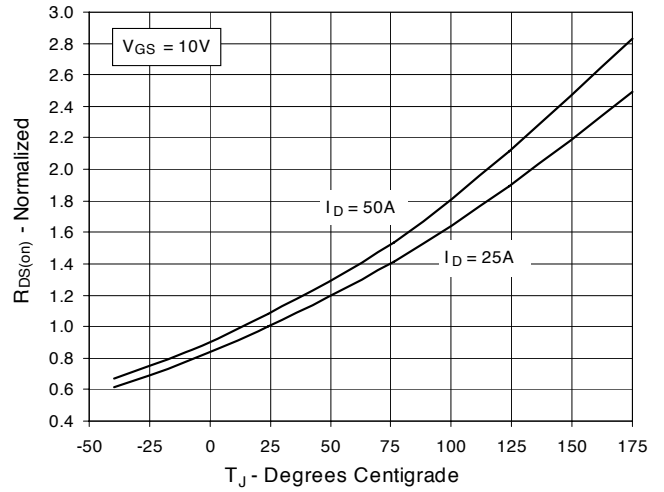

**Fig. 5.  $R_{DS(on)}$  Normalized to  $I_D = 25A$  Value vs. Drain Current**

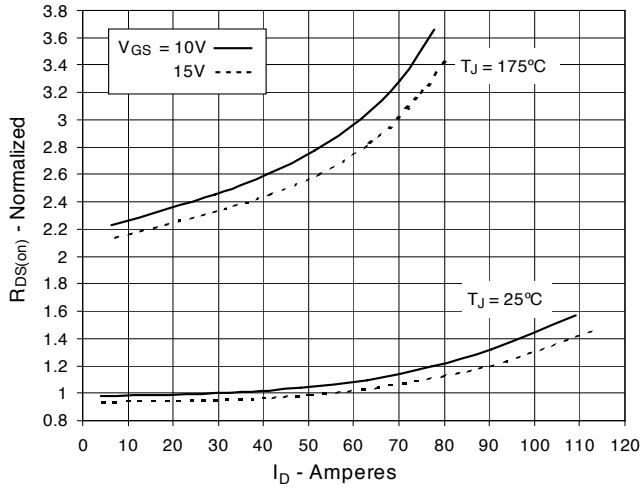

**Fig. 6. Drain Current vs. Case Temperature**

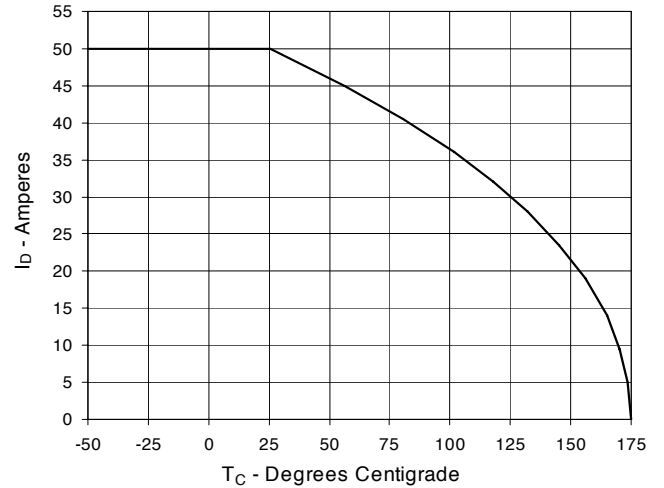

**Fig. 7. Input Admittance**

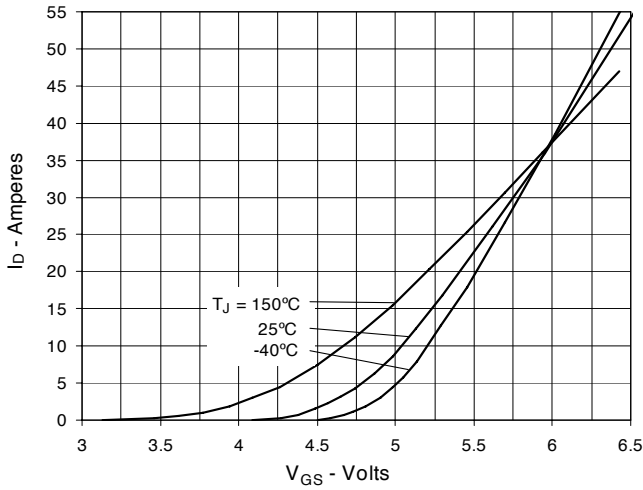

**Fig. 8. Transconductance**

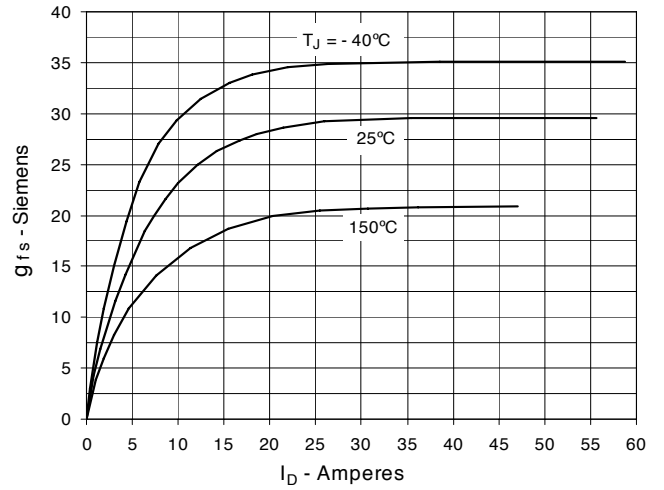

**Fig. 9. Forward Voltage Drop of Intrinsic Diode**

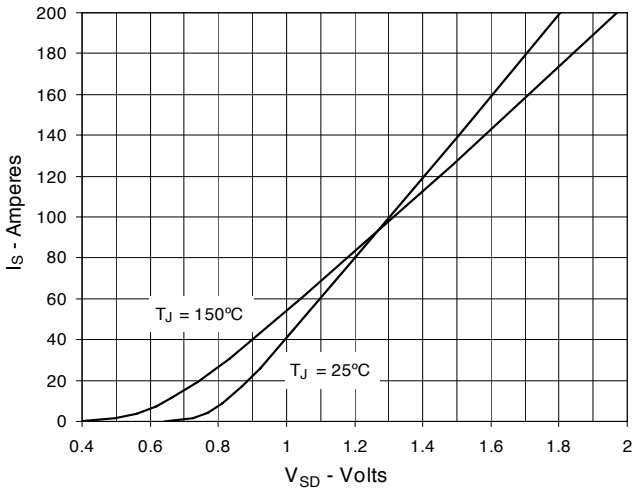

**Fig. 10. Gate Charge**

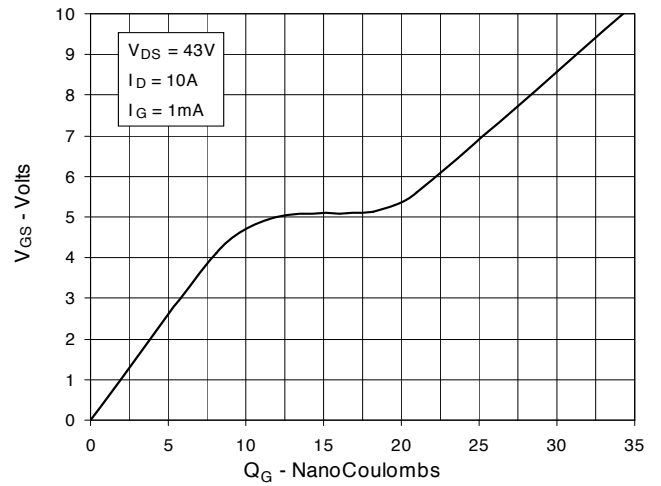

**Fig. 11. Capacitance**

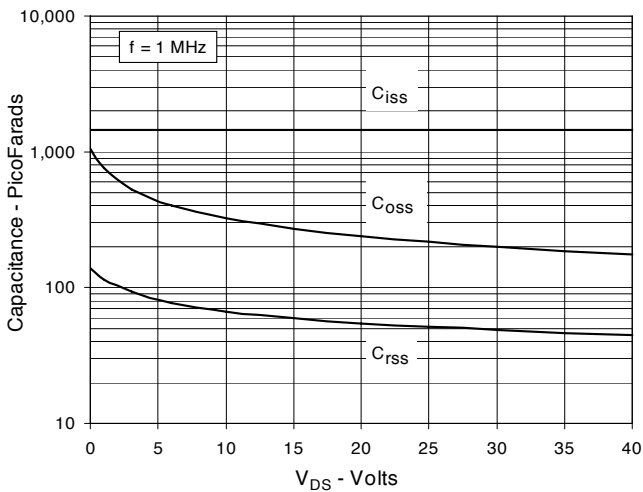

**Fig. 12. Maximum Transient Thermal Impedance**

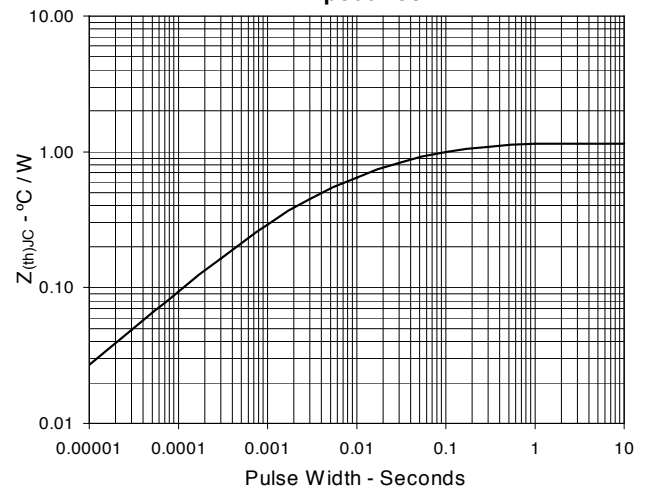

**Fig. 13. Resistive Turn-on  
Rise Time vs. Junction Temperature**

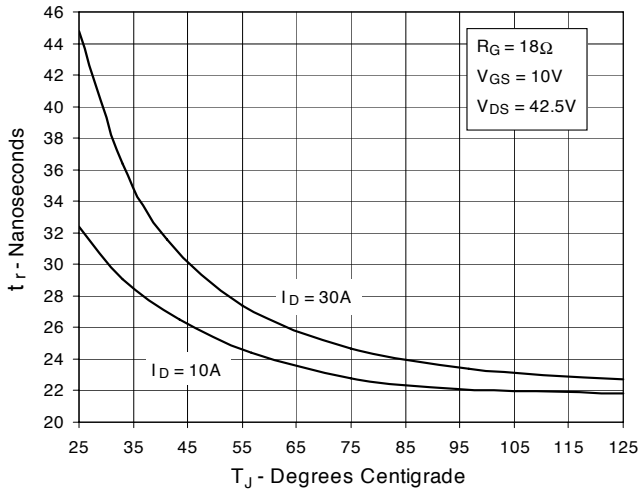

**Fig. 14. Resistive Turn-on  
Rise Time vs. Drain Current**

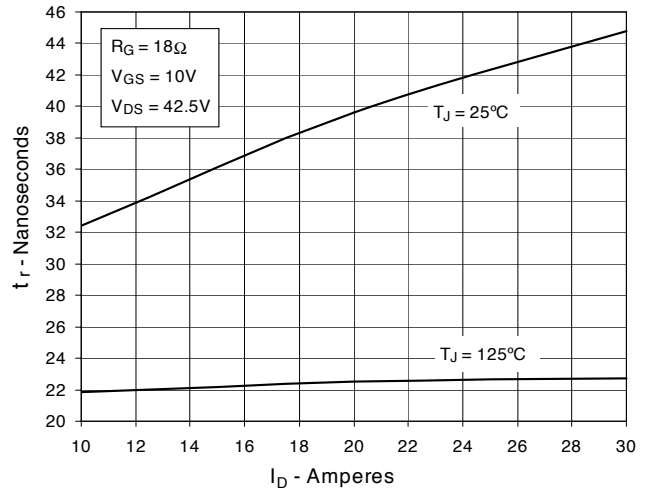

**Fig. 15. Resistive Turn-on  
Switching Times vs. Gate Resistance**

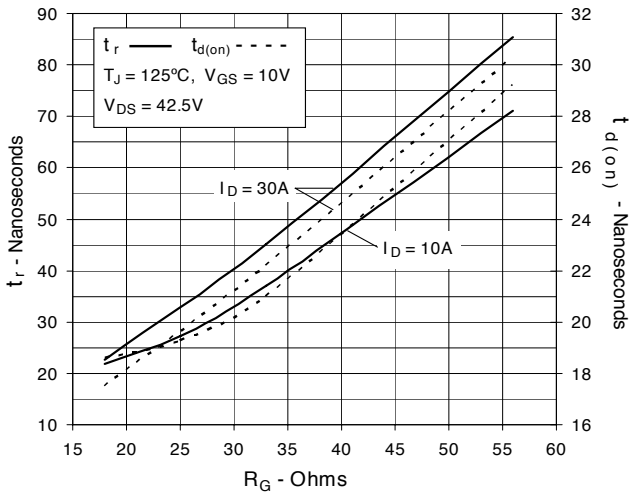

**Fig. 16. Resistive Turn-off  
Switching Times vs. Junction Temperature**

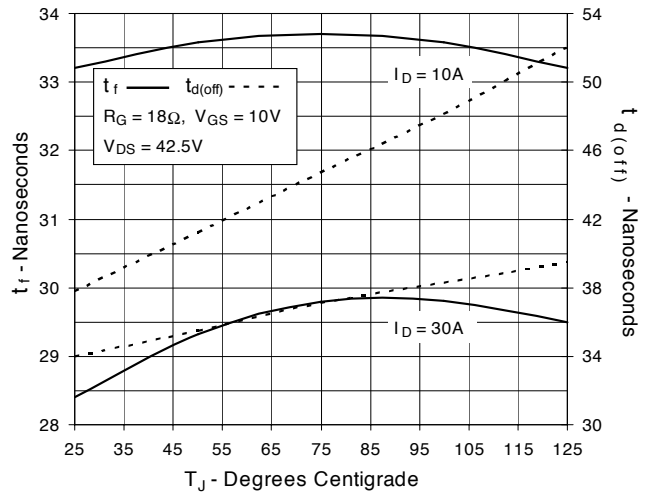

**Fig. 17. Resistive Turn-off  
Switching Times vs. Drain Current**

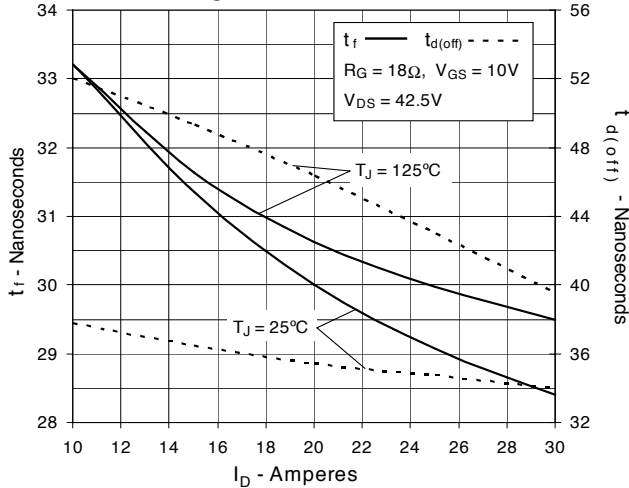

**Fig. 18. Resistive Turn-off  
Switching Times vs. Gate Resistance**

