

**XPT™ 650V IGBT  
GenX3™ w/Diode**
**IXYA15N65C3D1  
IXYP15N65C3D1**

$$V_{CES} = 650V$$

$$I_{C110} = 15A$$

$$V_{CE(sat)} \leq 2.5V$$

$$t_{fi(typ)} = 28ns$$

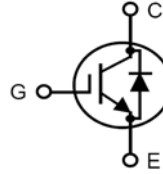
 Extreme Light Punch Through  
IGBT for 20-60kHz Switching

Symbol	Test Conditions	Maximum Ratings	
$V_{CES}$	$T_J = 25^\circ C$ to $175^\circ C$	650	V
$V_{CGR}$	$T_J = 25^\circ C$ to $175^\circ C$ , $R_{GE} = 1M\Omega$	650	V
$V_{GES}$	Continuous	$\pm 20$	V
$V_{GEM}$	Transient	$\pm 30$	V
$I_{C25}$	$T_C = 25^\circ C$	38	A
$I_{C110}$	$T_C = 110^\circ C$	15	A
$I_{F110}$	$T_C = 110^\circ C$	23	A
$I_{CM}$	$T_C = 25^\circ C$ , 1ms	80	A
$I_A$	$T_C = 25^\circ C$	5	A
$E_{AS}$	$T_C = 25^\circ C$	100	mJ
<b>SSOA</b>	$V_{GE} = 15V$ , $T_{VJ} = 150^\circ C$ , $R_G = 20\Omega$	$I_{CM} = 30$	A
<b>(RBSOA)</b>	Clamped Inductive Load	@ $V_{CE} \leq V_{CES}$	
$t_{sc}$	$V_{GE} = 15V$ , $V_{CE} = 360V$ , $T_J = 150^\circ C$	8	$\mu s$
<b>(SCSOA)</b>	$R_G = 82\Omega$ , Non Repetitive		
$P_C$	$T_C = 25^\circ C$	200	W
$T_J$		-55 ... +175	$^\circ C$
$T_{JM}$		175	$^\circ C$
$T_{stg}$		-55 ... +175	$^\circ C$
$T_L$	Maximum Lead Temperature for Soldering	300	$^\circ C$
$T_{SOLD}$	1.6 mm (0.062in.) from Case for 10s	260	$^\circ C$
$M_d$	Mounting Torque (TO-220)	1.13/10	Nm/lb.in
$F_C$	Mounting Force (TO-263)	10..65 / 2.2..14.6	N/lb
<b>Weight</b>	TO-263	2.5	g
	TO-220	3.0	g

TO-263 AA (IXYA)

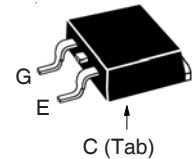

TO-220AB (IXYP)

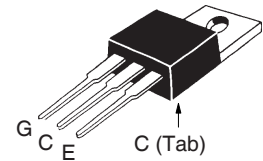

G = Gate      C = Collector  
E = Emitter    Tab = Collector

**Features**

- Optimized for 20-60kHz Switching
- Square RBSOA
- Avalanche Rated
- Anti-Parallel Fast Diode
- Short Circuit Capability
- International Standard Packages

**Advantages**

- High Power Density
- Extremely Rugged
- Low Gate Drive Requirement

**Applications**

- Power Inverters
- UPS
- Motor Drives
- SMPS
- PFC Circuits
- Battery Chargers
- Welding Machines
- Lamp Ballasts
- High Frequency Power Inverters

Symbol	Test Conditions ( $T_J = 25^\circ C$ , Unless Otherwise Specified)	Characteristic Values		
		Min.	Typ.	Max.
$BV_{CES}$	$I_C = 250\mu A$ , $V_{GE} = 0V$	650		V
$V_{GE(th)}$	$I_C = 250\mu A$ , $V_{CE} = V_{GE}$	3.5		V
$I_{CES}$	$V_{CE} = V_{CES}$ , $V_{GE} = 0V$ $T_J = 150^\circ C$			10 $\mu A$ 400 $\mu A$
$I_{GES}$	$V_{CE} = 0V$ , $V_{GE} = \pm 20V$			$\pm 100$ nA
$V_{CE(sat)}$	$I_C = 15A$ , $V_{GE} = 15V$ , Note 1 $T_J = 150^\circ C$		1.96 2.45	V V

Symbol Test Conditions		Characteristic Values		
(T <sub>J</sub> = 25°C Unless Otherwise Specified)		Min.	Typ.	Max.
<b>g<sub>fs</sub></b>	I <sub>C</sub> = 15A, V <sub>CE</sub> = 10V, Note 1	5.0	8.5	S
<b>C<sub>ies</sub></b>	V <sub>CE</sub> = 25V, V <sub>GE</sub> = 0V, f = 1MHz		583	pF
<b>C<sub>oes</sub></b>				
<b>C<sub>res</sub></b>				
<b>Q<sub>g(on)</sub></b>	I <sub>C</sub> = 15A, V <sub>GE</sub> = 15V, V <sub>CE</sub> = 0.5 • V <sub>CES</sub>		19	nC
<b>Q<sub>ge</sub></b>				
<b>Q<sub>gc</sub></b>				
<b>t<sub>d(on)</sub></b>	Inductive load, T <sub>J</sub> = 25°C I <sub>C</sub> = 15A, V <sub>GE</sub> = 15V V <sub>CE</sub> = 400V, R <sub>G</sub> = 20Ω Note 2		15	ns
<b>t<sub>ri</sub></b>				
<b>E<sub>on</sub></b>				
<b>t<sub>d(off)</sub></b>				
<b>t<sub>fi</sub></b>				
<b>E<sub>off</sub></b>	0.23	0.40	mJ	
<b>t<sub>d(on)</sub></b>	Inductive load, T <sub>J</sub> = 150°C I <sub>C</sub> = 15A, V <sub>GE</sub> = 15V V <sub>CE</sub> = 400V, R <sub>G</sub> = 20Ω Note 2		15	ns
<b>t<sub>ri</sub></b>				
<b>E<sub>on</sub></b>				
<b>t<sub>d(off)</sub></b>				
<b>t<sub>fi</sub></b>				
<b>E<sub>off</sub></b>	0.24		mJ	
<b>R<sub>thJC</sub></b>	TO-220	0.50	0.75 °C/W	
<b>R<sub>thCS</sub></b>			°C/W	

**Reverse Diode (FRED)**

Symbol Test Conditions		Characteristic Values		
(T <sub>J</sub> = 25°C, Unless Otherwise Specified)		Min.	Typ.	Max.
<b>V<sub>F</sub></b>	I <sub>F</sub> = 10A, V <sub>GE</sub> = 0V, Note 1 T <sub>J</sub> = 125°C		1.7	3.0 V
<b>I<sub>RM</sub></b>	I <sub>F</sub> = 12A, V <sub>GE</sub> = 0V, -di <sub>F</sub> /dt = 100A/μs, V <sub>R</sub> = 100V, T <sub>J</sub> = 125°C		2.5	A
<b>t<sub>rr</sub></b>				
<b>t<sub>rr</sub></b>	I <sub>F</sub> = 1A, V <sub>GE</sub> = 0V, -di <sub>F</sub> /dt = 100A/μs, V <sub>R</sub> = 30V		30	ns
<b>R<sub>thJC</sub></b>				1.85 °C/W

**Notes:**

1. Pulse test, t ≤ 300μs, duty cycle, d ≤ 2%.
2. Switching times & energy losses may increase for higher V<sub>CE</sub> (clamp), T<sub>J</sub> or R<sub>G</sub>.

**PRELIMINARY TECHNICAL INFORMATION**

The product presented herein is under development. The Technical Specifications offered are derived from a subjective evaluation of the design, based upon prior knowledge and experience, and constitute a "considered reflection" of the anticipated result. IXYS reserves the right to change limits, test conditions, and dimensions without notice.

**TO-263 Outline**

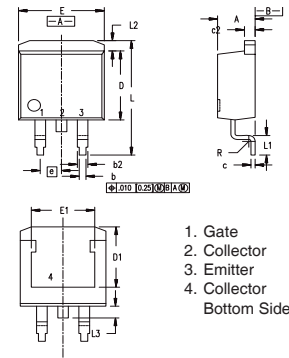

Dim.	Millimeter		Inches	
	Min.	Max.	Min.	Max.
A	4.06	4.83	.160	.190
b	0.51	0.99	.020	.039
b2	1.14	1.40	.045	.055
c	0.40	0.74	.016	.029
c2	1.14	1.40	.045	.055
D	8.64	9.65	.340	.380
D1	8.00	8.89	.280	.320
E	9.65	10.41	.380	.405
E1	6.22	8.13	.270	.320
e	2.54	BSC	.100	BSC
L	14.61	15.88	.575	.625
L1	2.29	2.79	.090	.110
L2	1.02	1.40	.040	.055
L3	1.27	1.78	.050	.070
L4	0	0.13	0	.005

**TO-220 Outline**

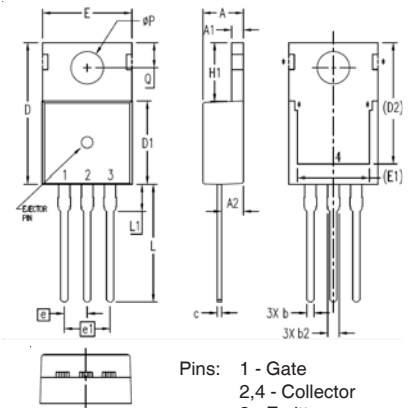

Pins: 1 - Gate, 2,4 - Collector, 3 - Emitter

SYM	INCHES		MILLIMETERS	
	MIN	MAX	MIN	MAX
A	.169	.185	4.30	4.70
A1	.047	.055	1.20	1.40
A2	.079	.106	2.00	2.70
b	.024	.039	0.60	1.00
b2	.045	.057	1.15	1.45
c	.014	.026	0.35	0.65
D	.587	.626	14.90	15.90
D1	.335	.370	8.50	9.40
(D2)	.500	.531	12.70	13.50
E	.382	.406	9.70	10.30
(E1)	.283	.323	7.20	8.20
e	.100 BSC		2.54 BSC	
e1	.200 BSC		5.08 BSC	
H1	.244	.268	6.20	6.80
L	.492	.547	12.50	13.90
L1	.110	.154	2.80	3.90
∅P	.134	.150	3.40	3.80
Q	.106	.126	2.70	3.20

**IXYS Reserves the Right to Change Limits, Test Conditions, and Dimensions.**

IXYS MOSFETs and IGBTs are covered by one or more of the following U.S. patents:	4,835,592	4,931,844	5,049,961	5,237,481	6,162,665	6,404,065 B1	6,683,344	6,727,585	7,005,734 B2	7,157,338B2
	4,860,072	5,017,508	5,063,307	5,381,025	6,259,123 B1	6,534,343	6,710,405 B2	6,759,692	7,063,975 B2	
	4,881,106	5,034,796	5,187,117	5,486,715	6,306,728 B1	6,583,505	6,710,463	6,771,478 B2	7,071,537	

**Fig. 1. Output Characteristics @  $T_J = 25^\circ\text{C}$**

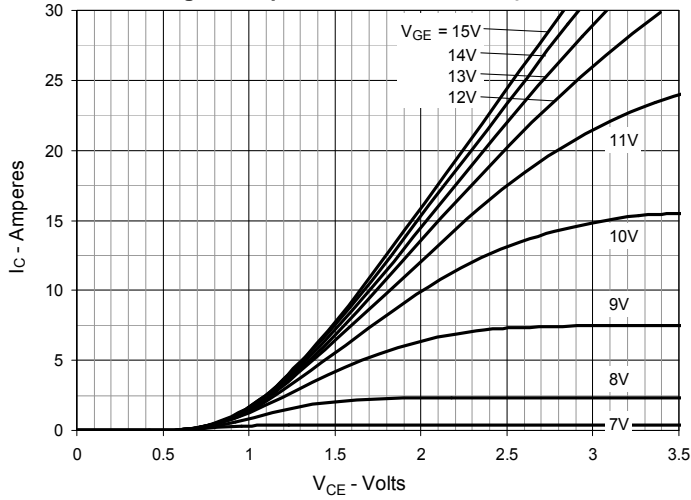

**Fig. 2. Extended Output Characteristics @  $T_J = 25^\circ\text{C}$**

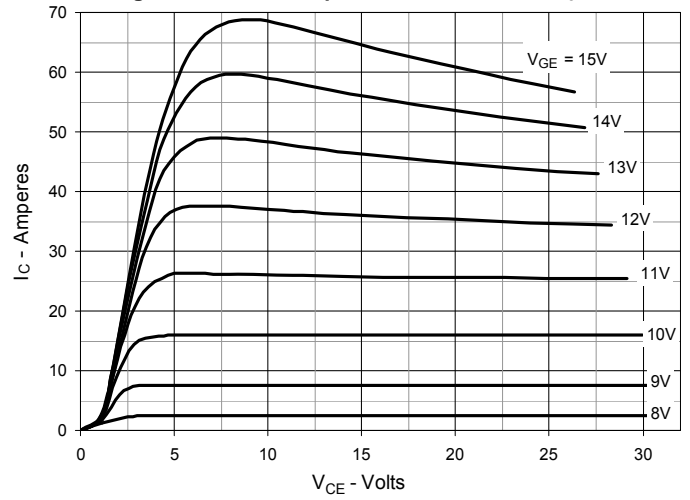

**Fig. 3. Output Characteristics @  $T_J = 150^\circ\text{C}$**

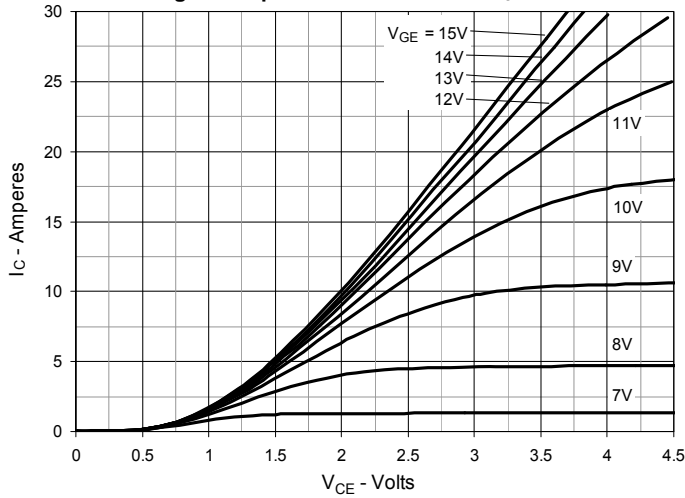

**Fig. 4. Dependence of  $V_{CE(sat)}$  on Junction Temperature**

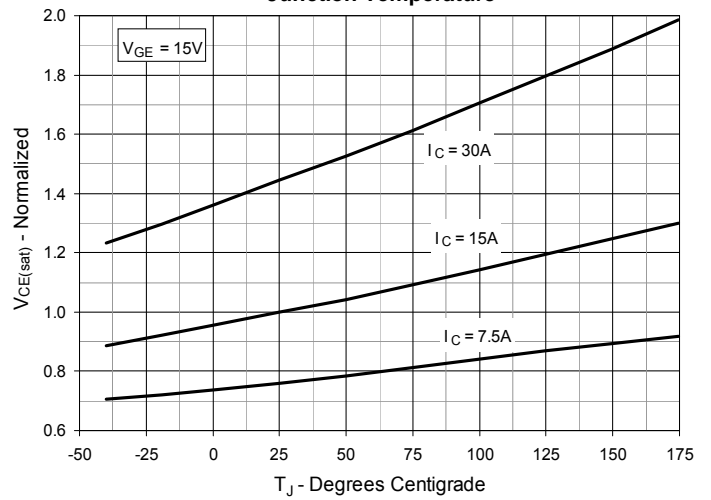

**Fig. 5. Collector-to-Emitter Voltage vs. Gate-to-Emitter Voltage**

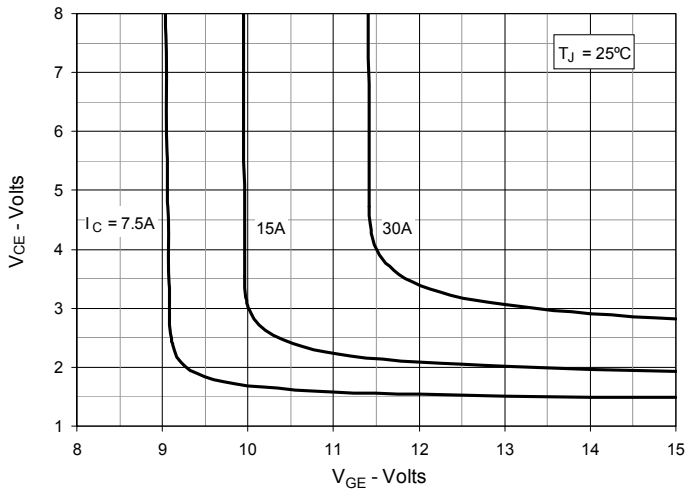

**Fig. 6. Input Admittance**

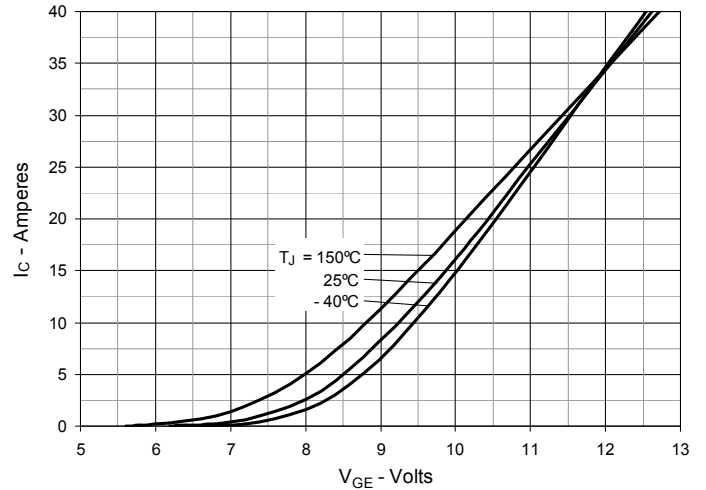

**Fig. 7. Transconductance**

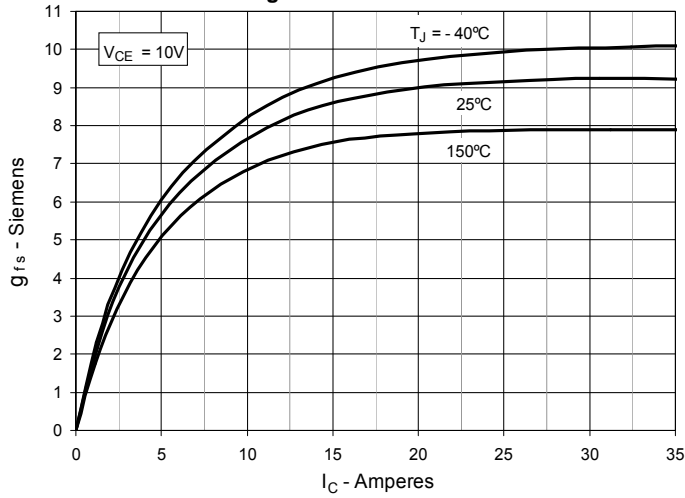

**Fig. 8. Gate Charge**

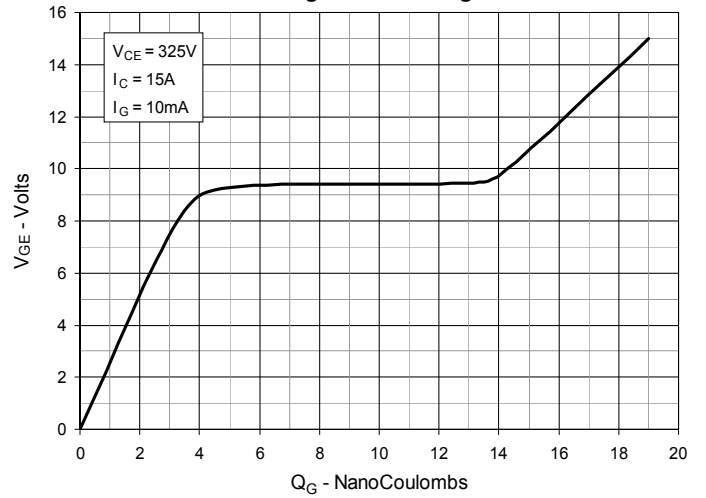

**Fig. 9. Capacitance**

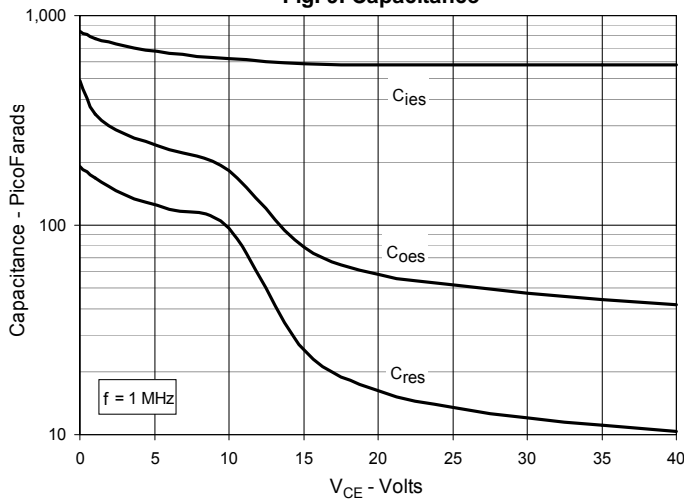

**Fig. 10. Reverse-Bias Safe Operating Area**

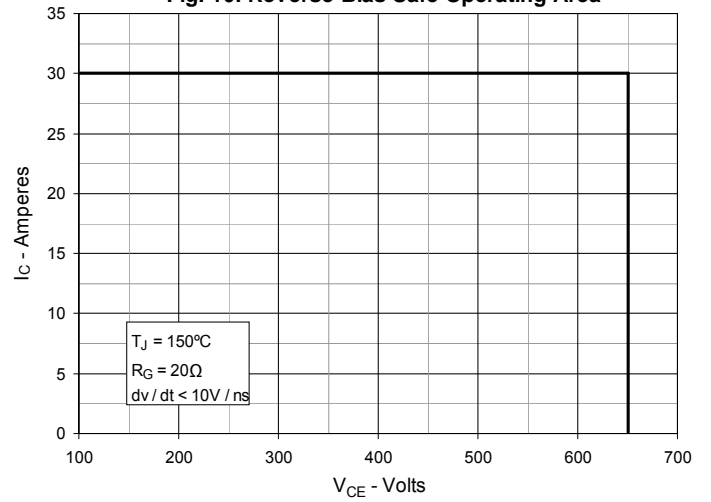

**Fig. 11. Maximum Transient Thermal Impedance**

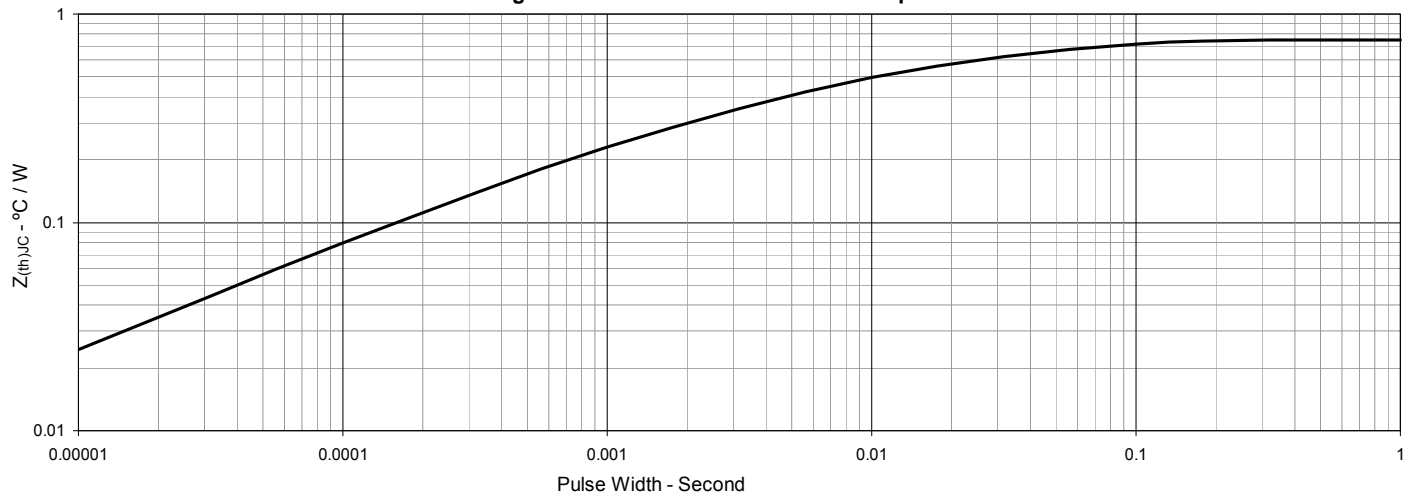

**Fig. 12. Inductive Switching Energy Loss vs. Gate Resistance**

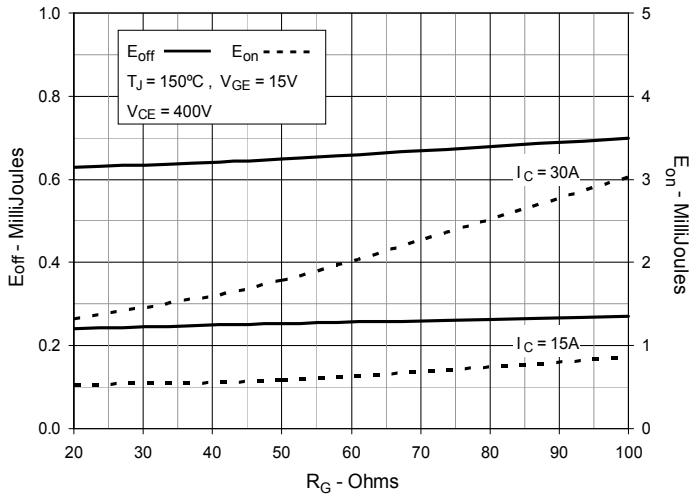

**Fig. 13. Inductive Switching Energy Loss vs. Collector Current**

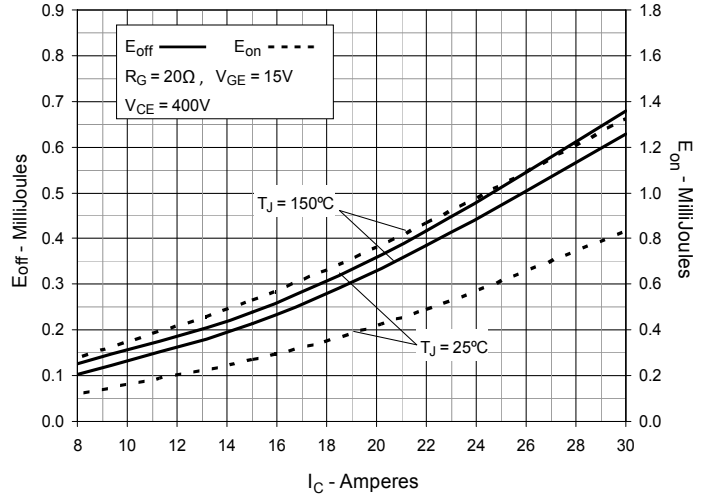

**Fig. 14. Inductive Switching Energy Loss vs. Junction Temperature**

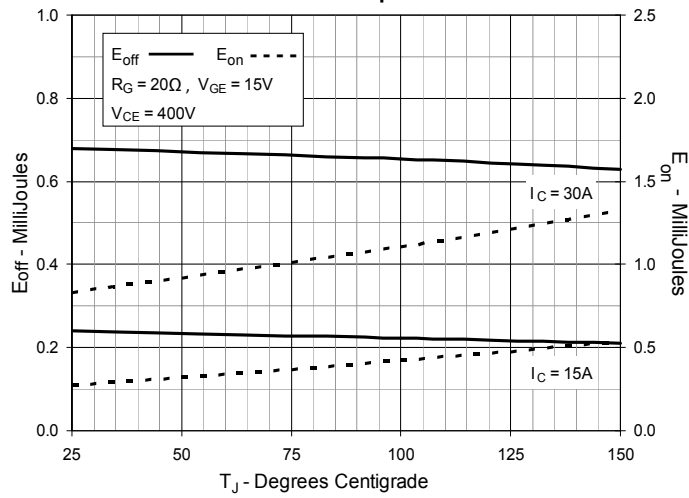

**Fig. 15. Inductive Turn-off Switching Times vs. Gate Resistance**

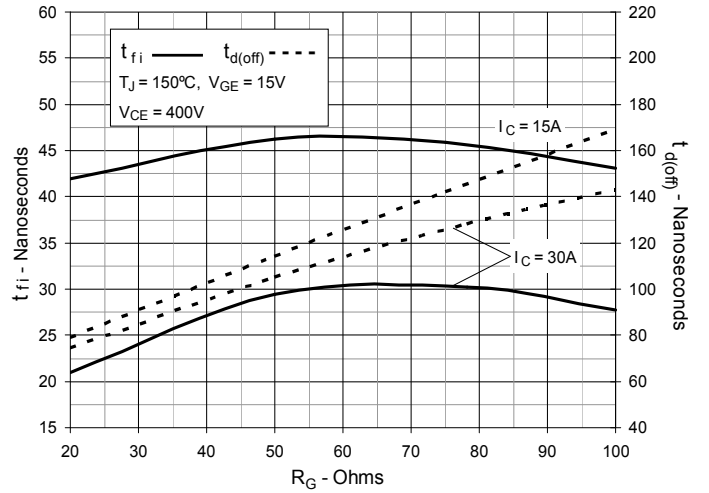

**Fig. 16. Inductive Turn-off Switching Times vs. Collector Current**

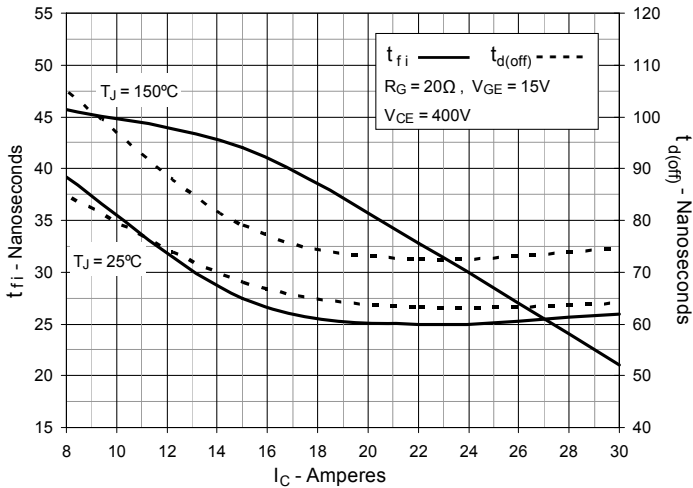

**Fig. 17. Inductive Turn-off Switching Times vs. Junction Temperature**

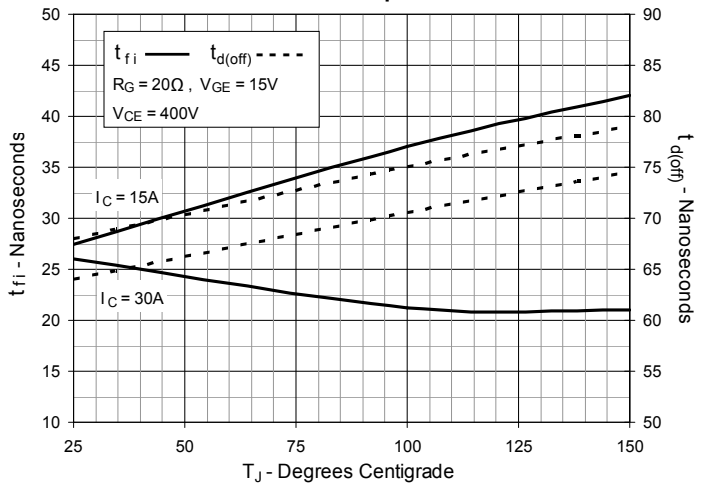

**Fig. 18. Inductive Turn-on Switching Times vs. Gate Resistance**

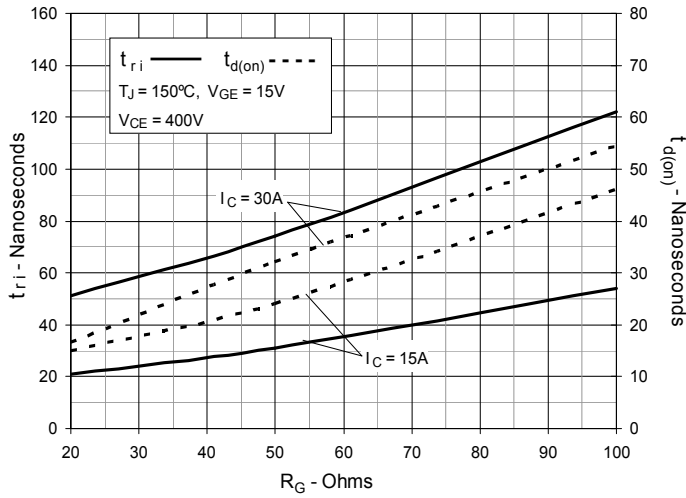

**Fig. 19. Inductive Turn-on Switching Times vs. Collector Current**

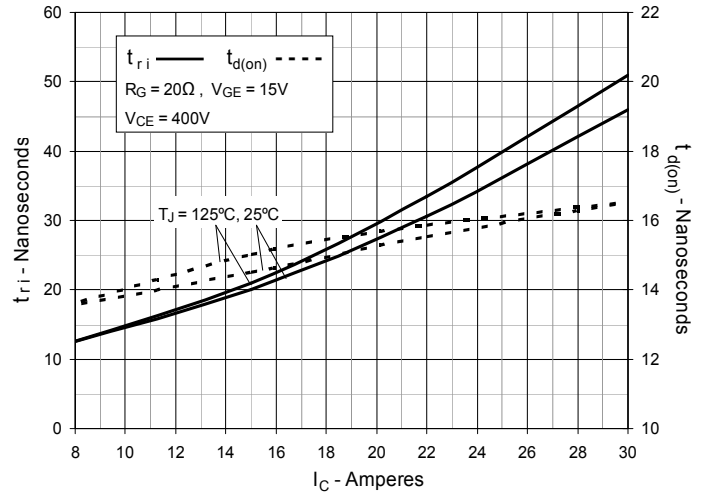

**Fig. 20. Inductive Turn-on Switching Times vs. Junction Temperature**

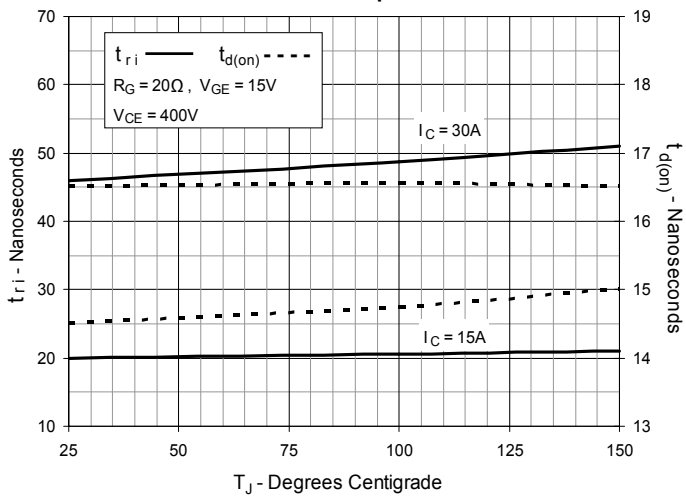

**Fig. 21. Maximum Transient Impedance for Diode**

