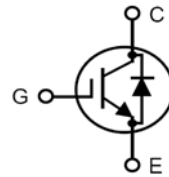

**900V XPT™ IGBT
GenX3™ w/Diode**
IXYH24N90C3D1

 High-Speed IGBT
for 20-50 kHz Switching

$$V_{CES} = 900V$$

$$I_{C90} = 24A$$

$$V_{CE(sat)} \leq 3.0V$$

$$t_{fi(typ)} = 90ns$$

Symbol	Test Conditions	Maximum Ratings	
V_{CES}	$T_J = 25^\circ C$ to $150^\circ C$	900	V
V_{CGR}	$T_J = 25^\circ C$ to $150^\circ C$, $R_{GE} = 1M\Omega$	900	V
V_{GES}	Continuous	± 20	V
V_{GEM}	Transient	± 30	V
I_{C25}	$T_C = 25^\circ C$	44	A
I_{C90}	$T_C = 90^\circ$	24	A
I_{F110}	$T_C = 110^\circ C$	15	A
I_{CM}	$T_C = 25^\circ C$, 1ms	105	A
I_A	$T_C = 25^\circ C$	15	A
E_{AS}	$T_C = 25^\circ C$	150	mJ
SSOA (RBSOA)	$V_{GE} = 15V$, $T_{VJ} = 125^\circ C$, $R_G = 10\Omega$ Clamped Inductive Load	$I_{CM} = 48$ @ $V_{CE} \leq V_{CES}$	A
P_C	$T_C = 25^\circ C$	200	W
T_J		-55 ... +150	$^\circ C$
T_{JM}		150	$^\circ C$
T_{stg}		-55 ... +150	$^\circ C$
T_L	Maximum Lead Temperature for Soldering	300	$^\circ C$
T_{SOLD}	1.6 mm (0.062in.) from Case for 10s	260	$^\circ C$
M_d	Mounting Torque	1.13/10	Nm/lb.in.
Weight		6	g

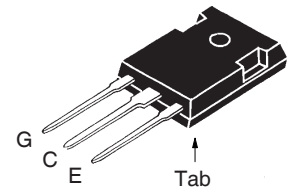
TO-247

G = Gate C = Collector
E = Emitter Tab = Collector

Features

- Optimized for Low Switching Losses
- Square RBSOA
- Positive Thermal Coefficient of $V_{ce(sat)}$
- Anti-Parallel Ultra Fast Diode
- Avalanche Rated
- High Current Handling Capability
- International Standard Package

Advantages

- High Power Density
- Low Gate Drive Requirement

Applications

- High Frequency Power Inverters
- UPS
- Motor Drives
- SMPS
- PFC Circuits
- Battery Chargers
- Welding Machines
- Lamp Ballasts

Symbol	Test Conditions ($T_J = 25^\circ C$, Unless Otherwise Specified)	Characteristic Values		
		Min.	Typ.	Max.
BV_{CES}	$I_C = 250\mu A$, $V_{GE} = 0V$	950		V
$V_{GE(th)}$	$I_C = 250\mu A$, $V_{CE} = V_{GE}$	3.5		6.0 V
I_{CES}	$V_{CE} = V_{CES}$, $V_{GE} = 0V$ $T_J = 125^\circ C$			75 μA 400 μA
I_{GES}	$V_{CE} = 0V$, $V_{GE} = \pm 20V$			± 100 nA
$V_{CE(sat)}$	$I_C = 24A$, $V_{GE} = 15V$, Note 1 $T_J = 125^\circ C$		2.30 2.95	3.00 V V

Symbol Test Conditions		Characteristic Values		
(T _J = 25°C Unless Otherwise Specified)		Min.	Typ.	Max.
g_{fs}	I _C = 24A, V _{CE} = 10V, Note 1	8	14	S
C_{ies}	V _{CE} = 25V, V _{GE} = 0V, f = 1MHz		1190	pF
C_{oes}			64	pF
C_{res}			22	pF
Q_{g(on)}	I _C = 24A, V _{GE} = 15V, V _{CE} = 0.5 • V _{CES}		40	nC
Q_{ge}			10	nC
Q_{gc}			18	nC
t_{d(on)}	Inductive load, T_J = 25°C I _C = 24A, V _{GE} = 15V V _{CE} = 0.5 • V _{CES} , R _G = 10Ω Note 2		20	ns
t_{ri}			36	ns
E_{on}			1.35	mJ
t_{d(off)}			73	ns
t_{fi}			90	ns
E_{off}			0.40	0.70 mJ
t_{d(on)}	Inductive load, T_J = 125°C I _C = 24A, V _{GE} = 15V V _{CE} = 0.5 • V _{CES} , R _G = 10Ω Note 2		22	ns
t_{ri}			38	ns
E_{on}			2.60	mJ
t_{d(off)}			85	ns
t_{fi}			130	ns
E_{off}			0.55	mJ
R_{thJC}				0.62 °C/W
R_{thCS}		0.21		°C/W

Reverse Diode (FRED)

Symbol Test Conditions		Characteristic Value		
(T _J = 25°C, Unless Otherwise Specified)		Min.	Typ.	Max.
V_F	I _F = 15A, V _{GE} = 0V, Note 1 T _J = 150°C		2.0	3.25 V
I_{RM}	I _F = 15A, V _{GE} = 0V, -di _F /dt = 250A/μs, T _J = 100°C		14	A
t_{rr}		V _R = 600V T _J = 100°C		340
R_{thJC}				1.6 °C/W

Notes:

1. Pulse test, t ≤ 300μs, duty cycle, d ≤ 2%.
2. Switching times & energy losses may increase for higher V_{CE} (clamp), T_J or R_G.

PRELIMINARY TECHNICAL INFORMATION

The product presented herein is under development. The Technical Specifications offered are derived from a subjective evaluation of the design, based upon prior knowledge and experience, and constitute a "considered reflection" of the anticipated result. IXYS reserves the right to change limits, test conditions, and dimensions without notice.

IXYS Reserves the Right to Change Limits, Test Conditions, and Dimensions.

IXYS MOSFETs and IGBTs are covered by one or more of the following U.S. patents:	4,835,592	4,931,844	5,049,961	5,237,481	6,162,665	6,404,065 B1	6,683,344	6,727,585	7,005,734 B2	7,157,338B2
	4,860,072	5,017,508	5,063,307	5,381,025	6,259,123 B1	6,534,343	6,710,405 B2	6,759,692	7,063,975 B2	
	4,881,106	5,034,796	5,187,117	5,486,715	6,306,728 B1	6,583,505	6,710,463	6,771,478 B2	7,071,537	

TO-247 (IXYH) Outline

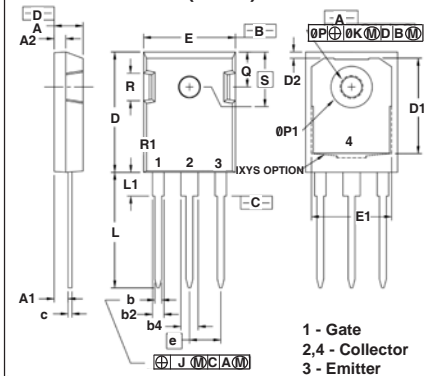

SYM	INCHES		MILLIMETERS	
	MIN	MAX	MIN	MAX
A	.190	.205	4.83	5.21
A1	.090	.100	2.29	2.54
A2	.075	.085	1.91	2.16
b	.045	.055	1.14	1.40
b2	.075	.087	1.91	2.20
b4	.115	.126	2.92	3.20
C	.024	.031	0.61	0.80
D	.819	.840	20.80	21.34
D1	.650	.690	16.51	17.53
D2	.035	.050	0.89	1.27
E	.620	.635	15.75	16.13
E1	.545	.565	13.84	14.35
e	.215 BSC		5.45 BSC	
J	--	.010	--	0.25
K	--	.025	--	0.64
L	.780	.810	19.81	20.57
L1	.150	.170	3.81	4.32
øP	.140	.144	3.55	3.65
øP1	.275	.290	6.99	7.37
Q	.220	.244	5.59	6.20
R	.170	.190	4.32	4.83
S	.242 BSC		6.15 BSC	

Fig. 1. Output Characteristics @ $T_J = 25^\circ\text{C}$

Fig. 2. Extended Output Characteristics @ $T_J = 25^\circ\text{C}$

Fig. 3. Output Characteristics @ $T_J = 150^\circ\text{C}$

Fig. 4. Dependence of $V_{CE(sat)}$ on Junction Temperature

Fig. 5. Collector-to-Emitter Voltage vs. Gate-to-Emitter Voltage

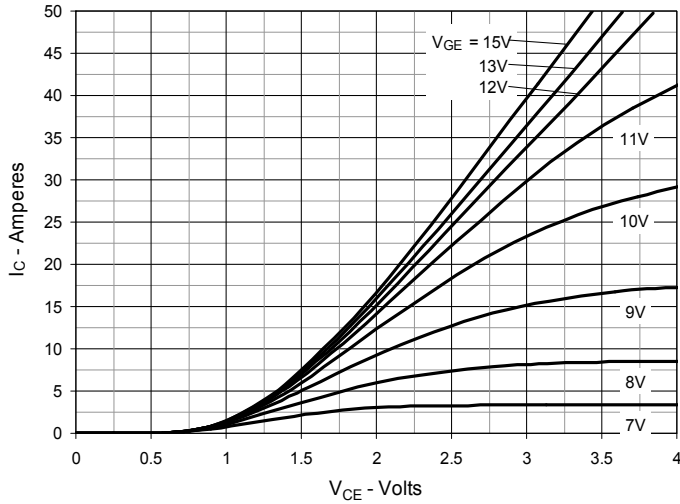
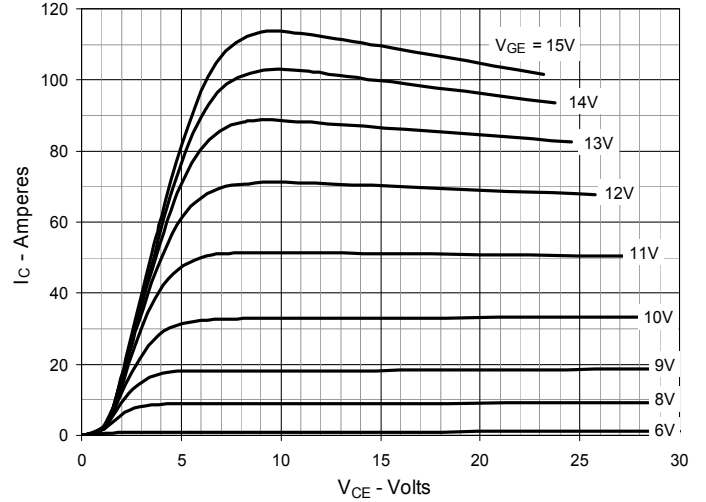
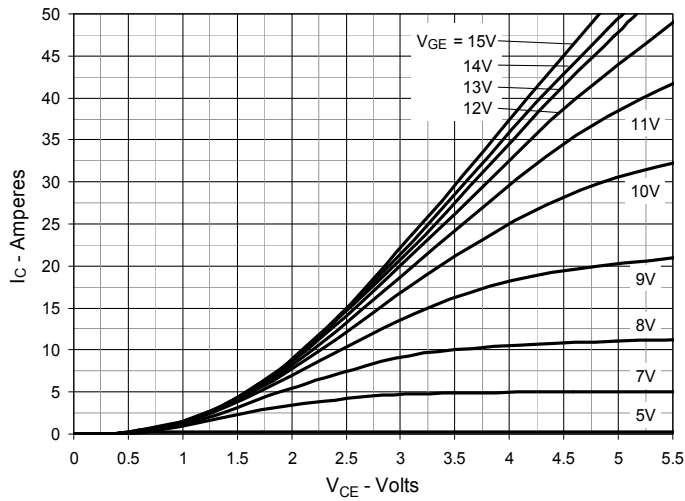
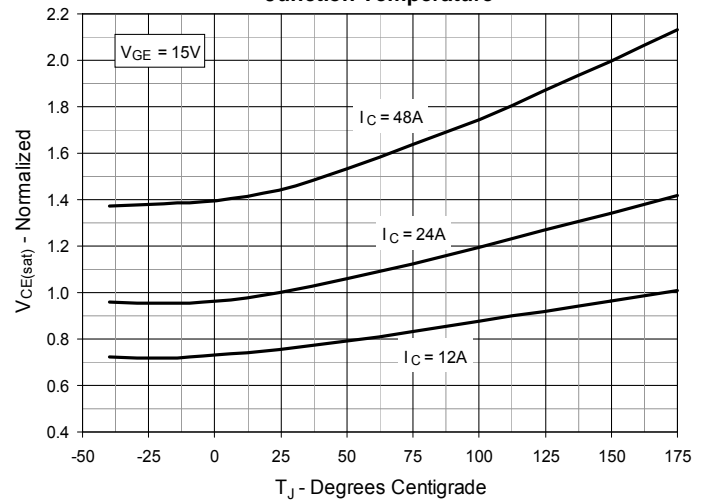
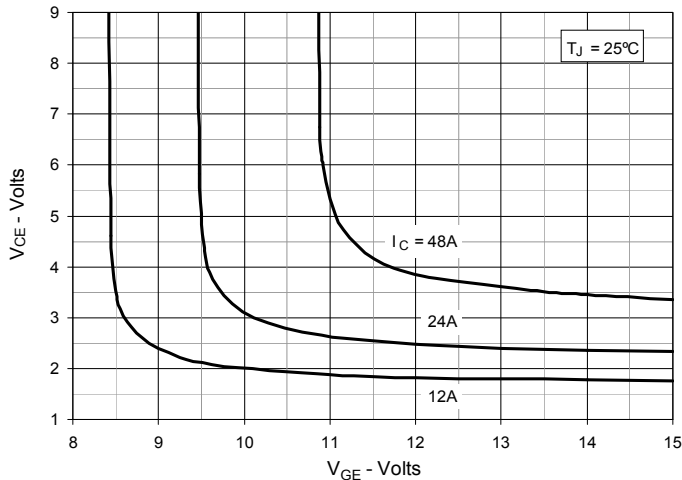
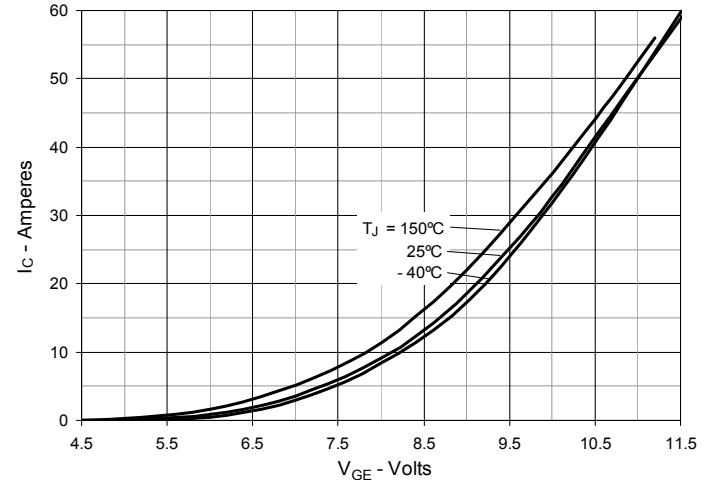
Fig. 6. Input Admittance

Fig. 7. Transconductance

Fig. 8. Gate Charge

Fig. 9. Capacitance

Fig. 10. Reverse-Bias Safe Operating Area

Fig. 11. Maximum Transient Thermal Impedance (IGBT)

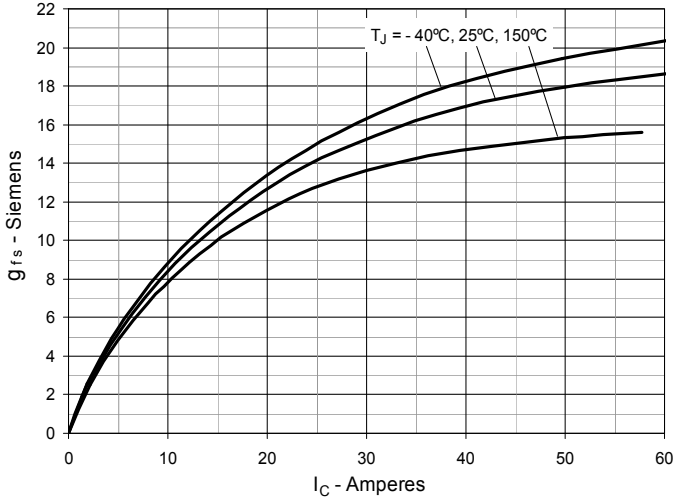
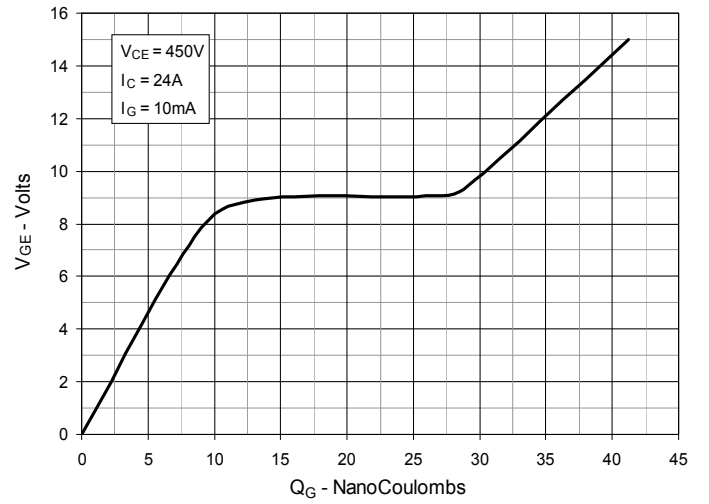
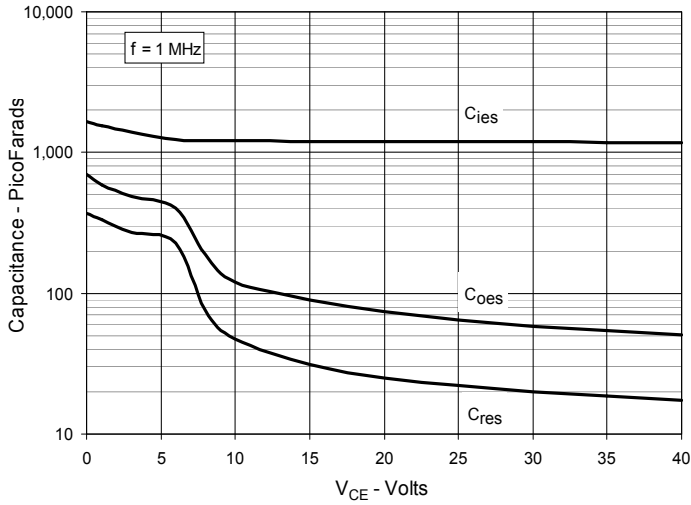
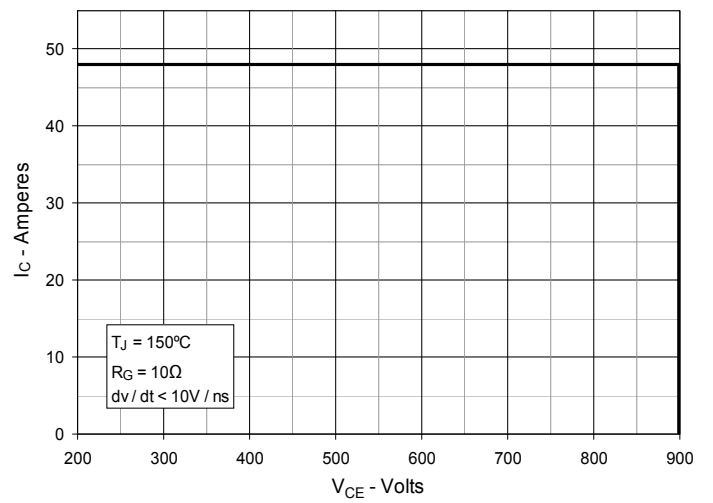
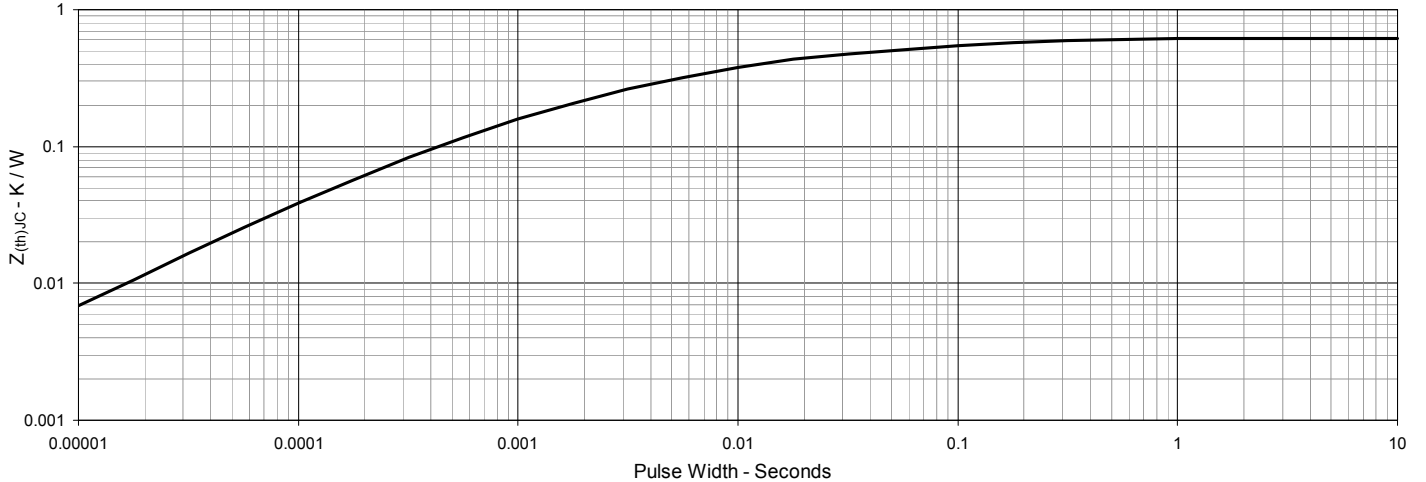
Fig. 12. Inductive Switching Energy Loss vs. Gate Resistance

Fig. 13. Inductive Switching Energy Loss vs. Collector Current

Fig. 14. Inductive Switching Energy Loss vs. Junction Temperature

Fig. 15. Inductive Turn-off Switching Times vs. Gate Resistance

Fig. 16. Inductive Turn-off Switching Times vs. Collector Current

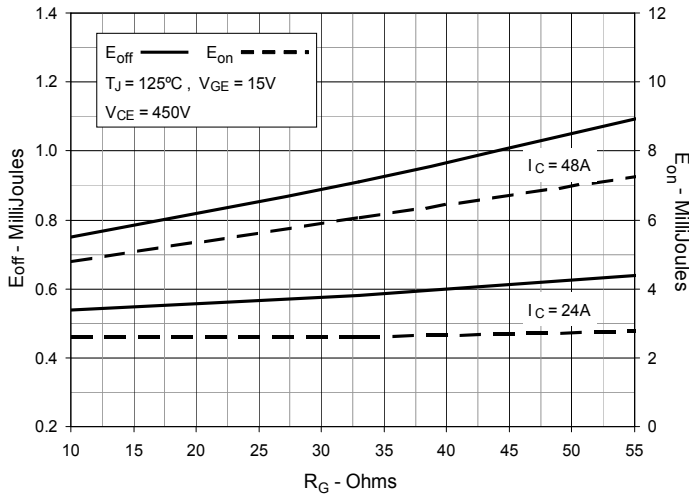
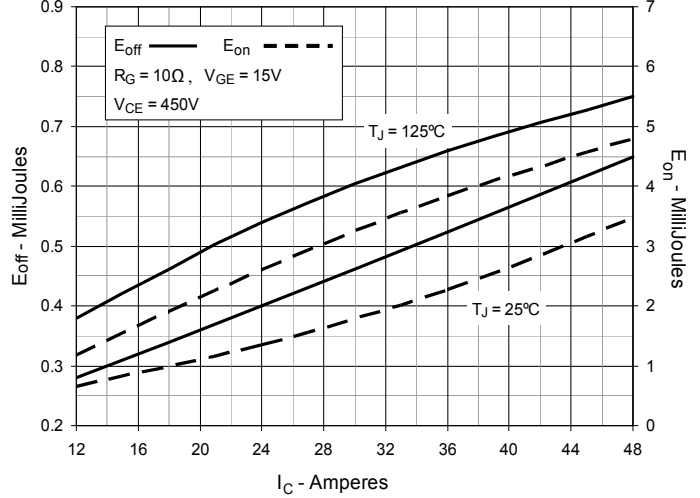
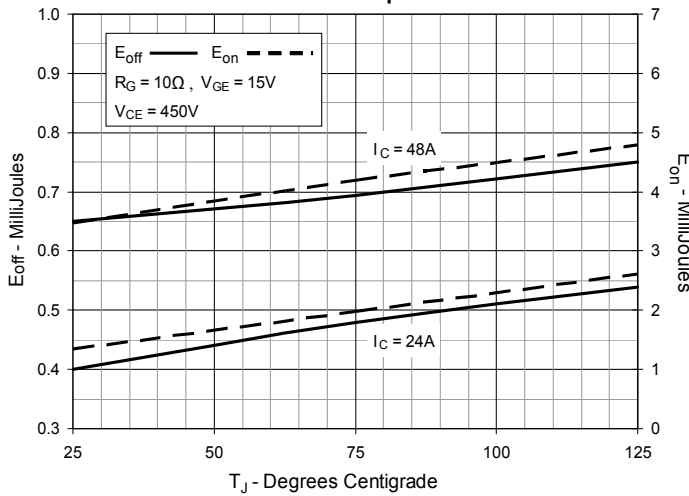
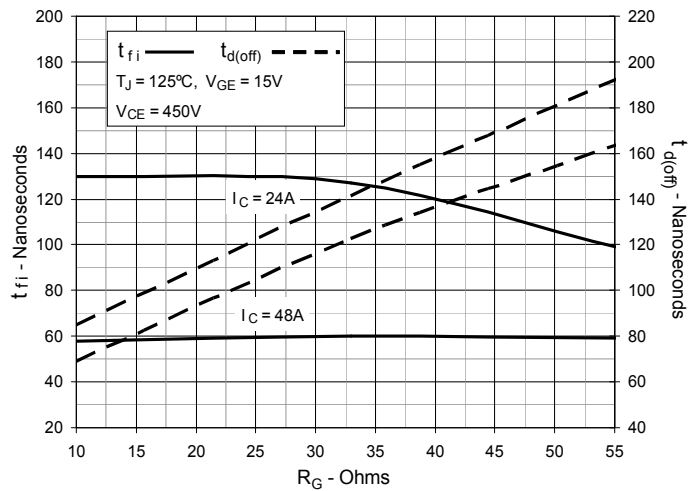
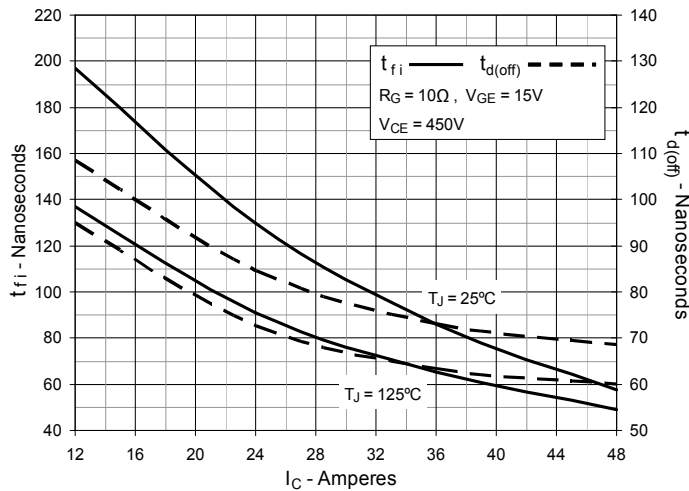
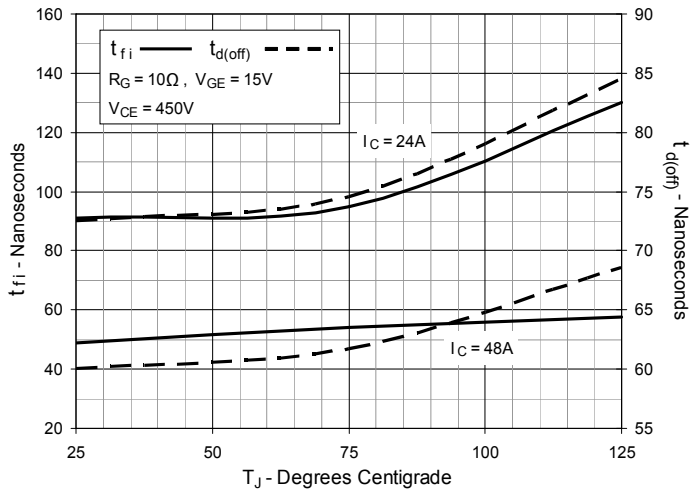
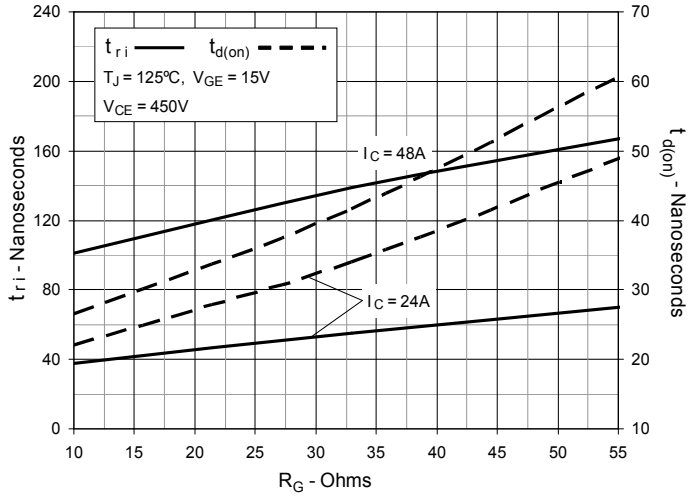
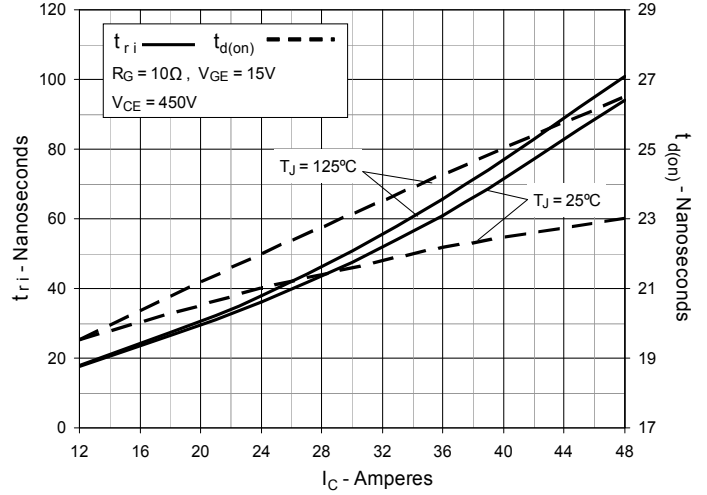
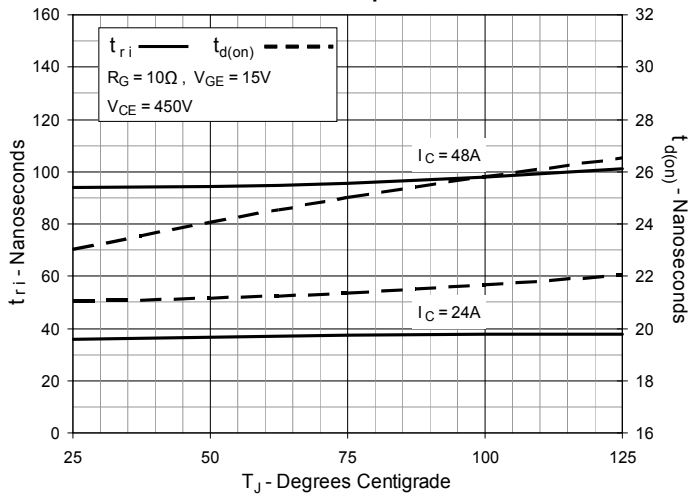
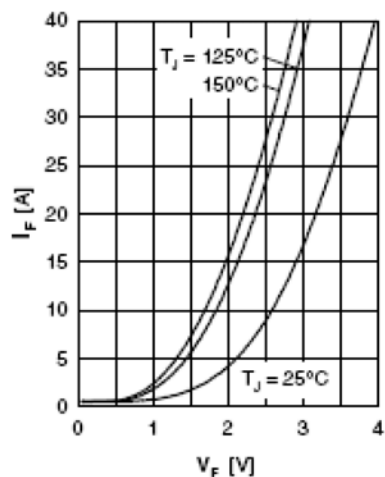
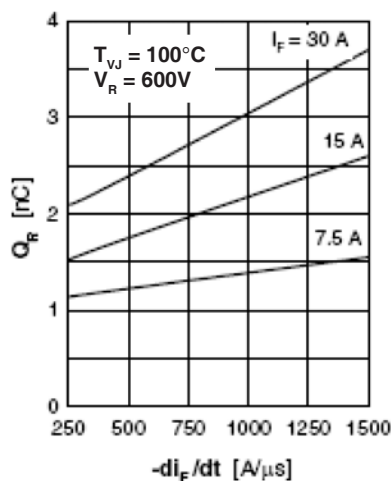
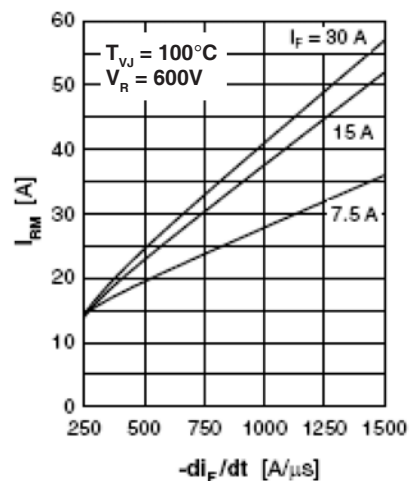
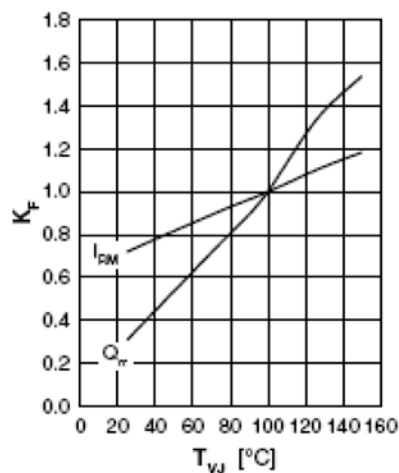
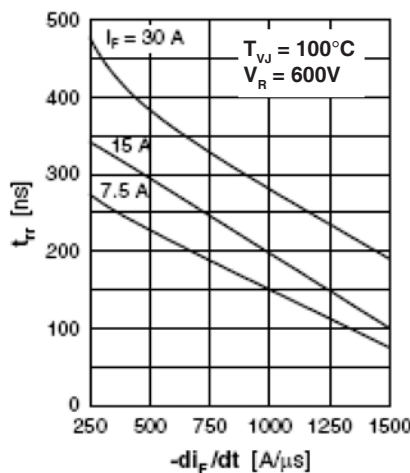
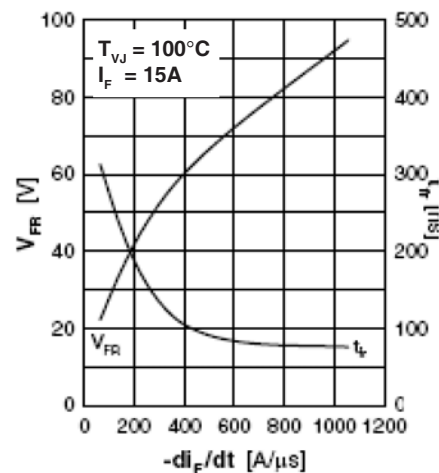
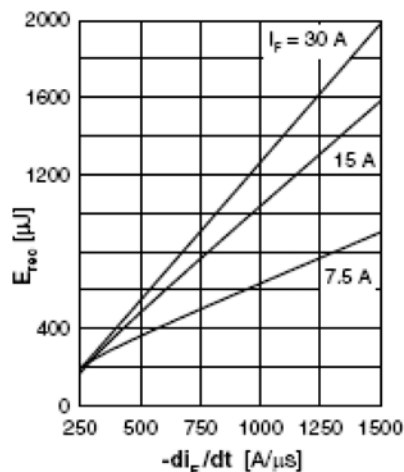
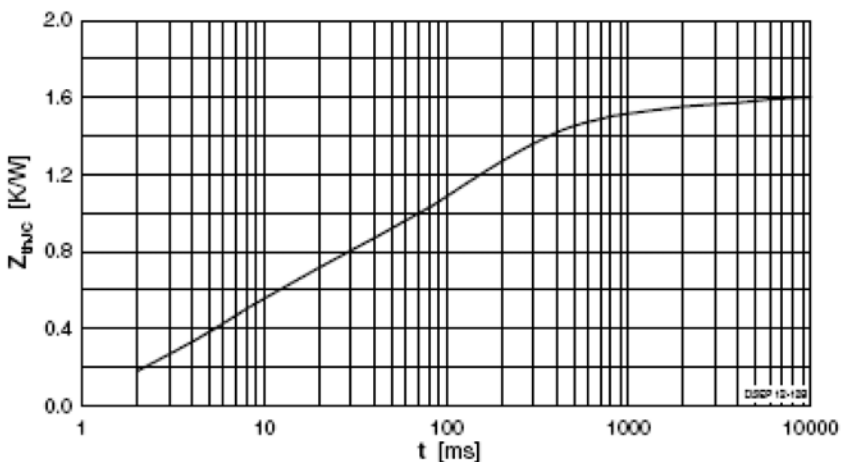
Fig. 17. Inductive Turn-off Switching Times vs. Junction Temperature

Fig. 18. Inductive Turn-on Switching Times vs. Gate Resistance

Fig. 19. Inductive Turn-on Switching Times vs. Collector Current

Fig. 20. Inductive Turn-on Switching Times vs. Junction Temperature



Fig. 21. Typ forward current I_F vs V_F

Fig. 22. Typ. reverse recovery charge Q_{RR} versus $-di_F/dt$

Fig. 23. Typ. peak reverse current I_{RM} versus $-di_F/dt$

Fig. 24. Dynamic parameters Q_{RR} , I_{RM} versus T_{VJ}

Fig. 25. Typ. recovery time t_r versus $-di_F/dt$

Fig. 26. Typ. peak forward voltage V_{FR} and t_f versus $-di_F/dt$

Fig. 27. Typ. recovery energy E_{REC} versus $-di_F/dt$

Fig. 28. Maximum transient thermal resistance junction to case



Disclaimer Notice - Information furnished is believed to be accurate and reliable. However, users should independently evaluate the suitability of and test each product selected for their own applications. Littelfuse products are not designed for, and may not be used in, all applications. Read complete Disclaimer Notice at www.littelfuse.com/disclaimer-electronics.