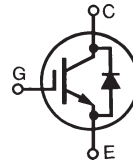

**XPT™ 650V IGBT  
GenX3™ w/ Sonic  
Diode**
**IXYT30N65C3H1HV  
IXYH30N65C3H1**

 Extreme Light Punch Through  
IGBT for 20-60kHz Switching

$$V_{CES} = 650V$$

$$I_{C110} = 30A$$

$$V_{CE(sat)} \leq 2.7V$$

$$t_{fi(typ)} = 24ns$$

Symbol	Test Conditions	Maximum Ratings	
$V_{CES}$	$T_J = 25^\circ C$ to $175^\circ C$	650	V
$V_{CGR}$	$T_J = 25^\circ C$ to $175^\circ C$ , $R_{GE} = 1M\Omega$	650	V
$V_{GES}$	Continuous	$\pm 20$	V
$V_{GEM}$	Transient	$\pm 30$	V
$I_{C25}$	$T_C = 25^\circ C$	60	A
$I_{C110}$	$T_C = 110^\circ C$	30	A
$I_{F110}$	$T_C = 110^\circ C$	29	A
$I_{CM}$	$T_C = 25^\circ C$ , 1ms	118	A
$I_A$	$T_C = 25^\circ C$	10	A
$E_{AS}$	$T_C = 25^\circ C$	300	mJ
<b>SSOA</b> <b>(RBSOA)</b>	$V_{GE} = 15V$ , $T_{VJ} = 150^\circ C$ , $R_G = 10\Omega$ Clamped Inductive Load	$I_{CM} = 60$ $V_{CE} \leq V_{CES}$	A
$t_{sc}$ <b>(SCSOA)</b>	$V_{GE} = 15V$ , $V_{CE} = 360V$ , $T_J = 150^\circ C$ $R_G = 82\Omega$ , Non Repetitive	8	$\mu s$
$P_C$	$T_C = 25^\circ C$	270	W
$T_J$		-55 ... +175	$^\circ C$
$T_{JM}$		175	$^\circ C$
$T_{stg}$		-55 ... +175	$^\circ C$
$T_L$	Maximum Lead Temperature for Soldering	300	$^\circ C$
$T_{SOLD}$	1.6 mm (0.062in.) from Case for 10s	260	$^\circ C$
$M_d$	Mounting Torque	1.13/10	Nm/lb.in
<b>Weight</b>	TO-220	4	g
	TO-247	6	g

TO-268HV

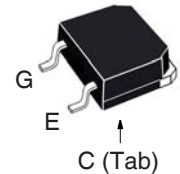

TO-247 AD

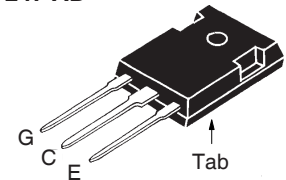
 G = Gate                      C = Collector  
 E = Emitter                 Tab = Collector

**Features**

- Optimized for 20-60kHz Switching
- Square RBSOA
- High Voltage
- Avalanche Rated
- Short Circuit Capability
- Anti-Parallel Sonic Diode

**Advantages**

- High Power Density
- Extremely Rugged
- Low Gate Drive Requirement

**Applications**

- Power Inverters
- UPS
- Motor Drives
- SMPS
- PFC Circuits
- Battery Chargers
- Welding Machines
- Lamp Ballasts
- High Frequency Power Inverters

Symbol	Test Conditions ( $T_J = 25^\circ C$ , Unless Otherwise Specified)	Characteristic Values		
		Min.	Typ.	Max.
$BV_{CES}$	$I_C = 250\mu A$ , $V_{GE} = 0V$	650		V
$V_{GE(th)}$	$I_C = 250\mu A$ , $V_{CE} = V_{GE}$	3.5		6.0 V
$I_{CES}$	$V_{CE} = V_{CES}$ , $V_{GE} = 0V$ $T_J = 150^\circ C$			50 $\mu A$ 4 mA
$I_{GES}$	$V_{CE} = 0V$ , $V_{GE} = \pm 20V$			$\pm 100$ nA
$V_{CE(sat)}$	$I_C = 30A$ , $V_{GE} = 15V$ , Note 1 $T_J = 150^\circ C$	2.35	2.70	V
		2.58		V

Symbol Test Conditions ( $T_J = 25^\circ\text{C}$ Unless Otherwise Specified)		Characteristic Values		
		Min.	Typ.	Max.
$g_{fs}$	$I_C = 30\text{A}, V_{CE} = 10\text{V}$ , Note 1	11	19	S
$C_{ies}$	$V_{CE} = 25\text{V}, V_{GE} = 0\text{V}, f = 1\text{MHz}$		1225	pF
$C_{oes}$			173	pF
$C_{res}$			28	pF
$Q_{g(on)}$	$I_C = 30\text{A}, V_{GE} = 15\text{V}, V_{CE} = 0.5 \cdot V_{CES}$		44	nC
$Q_{ge}$			7	nC
$Q_{gc}$			24	nC
$t_{d(on)}$	<b>Inductive load, <math>T_J = 25^\circ\text{C}</math></b> $I_C = 30\text{A}, V_{GE} = 15\text{V}$ $V_{CE} = 400\text{V}, R_G = 10\Omega$ Note 2		21	ns
$t_{ri}$			42	ns
$E_{on}$			1.00	mJ
$t_{d(off)}$			75	ns
$t_{fi}$			24	ns
$E_{off}$			0.27	mJ
$t_{d(on)}$	<b>Inductive load, <math>T_J = 150^\circ\text{C}</math></b> $I_C = 30\text{A}, V_{GE} = 15\text{V}$ $V_{CE} = 400\text{V}, R_G = 10\Omega$ Note 2		19	ns
$t_{ri}$			40	ns
$E_{on}$			1.50	mJ
$t_{d(off)}$			90	ns
$t_{fi}$			30	ns
$E_{off}$			0.41	mJ
$R_{thJC}$	TO-247			0.55 $^\circ\text{C/W}$
$R_{thCS}$			0.21	$^\circ\text{C/W}$

**Reverse Sonic Diode (FRD)**

Symbol Test Conditions ( $T_J = 25^\circ\text{C}$ Unless Otherwise Specified)		Characteristic Values		
		Min.	Typ.	Max.
$V_F$	$I_F = 30\text{A}, V_{GE} = 0\text{V}$ , Note 1	$T_J = 150^\circ\text{C}$	2.15	2.5 V
				V
$I_{RM}$	$I_F = 30\text{A}, V_{GE} = 0\text{V},$ $-di_F/dt = 500\text{A}/\mu\text{s}, V_R = 400\text{V}$	$T_J = 150^\circ\text{C}$	25	A
$t_{rr}$				$T_J = 150^\circ\text{C}$
$R_{thJC}$				0.80 $^\circ\text{C/W}$

Notes:

1. Pulse test,  $t \leq 300\mu\text{s}$ , duty cycle,  $d \leq 2\%$ .
2. Switching times & energy losses may increase for higher  $V_{CE}$  (clamp),  $T_J$  or  $R_G$ .

**PRELIMINARY TECHNICAL INFORMATION**

The product presented herein is under development. The Technical Specifications offered are derived from a subjective evaluation of the design, based upon prior knowledge and experience, and constitute a "considered reflection" of the anticipated result. IXYS reserves the right to change limits, test conditions, and dimensions without notice.

**IXYS Reserves the Right to Change Limits, Test Conditions, and Dimensions.**

IXYS MOSFETs and IGBTs are covered by one or more of the following U.S. patents:	4,835,592	4,931,844	5,049,961	5,237,481	6,162,665	6,404,065 B1	6,683,344	6,727,585	7,005,734 B2	7,157,338B2
	4,860,072	5,017,508	5,063,307	5,381,025	6,259,123 B1	6,534,343	6,710,405 B2	6,759,692	7,063,975 B2	
	4,881,106	5,034,796	5,187,117	5,486,715	6,306,728 B1	6,583,505	6,710,463	6,771,478 B2	7,071,537	

**TO-268HV Outline**

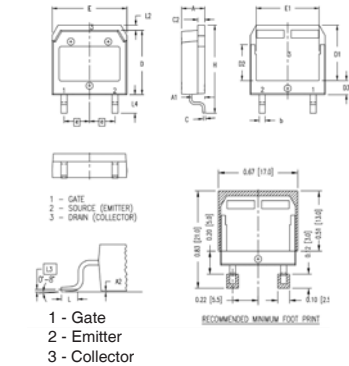

Dim.	Millimeter		Inches	
	min	max	min	max
A	4.90	5.10	0.193	0.201
A1	2.70	2.90	0.106	0.114
A2	0.02	0.25	0.001	0.100
b	1.15	1.45	0.045	0.057
C	0.40	0.65	0.016	0.026
C 2	1.45	1.60	0.057	0.063
D	13.80	14.00	0.543	0.551
D1	11.80	12.10	0.465	0.476
D2	7.50	7.80	0.295	0.307
D3	2.90	3.20	0.114	0.126
E	15.85	16.05	0.624	0.632
E1	13.30	13.60	0.524	0.535
e	5.45 BSC		0.215 BSC	
H	18.70	19.10	0.736	0.752
L	1.70	2.00	0.067	0.079
L2	1.00	1.15	0.039	0.045
L3	0.25 BSC		0.010 BSC	
L4	3.80	4.10	0.150	0.161

**TO-247 (IXYH) Outline**

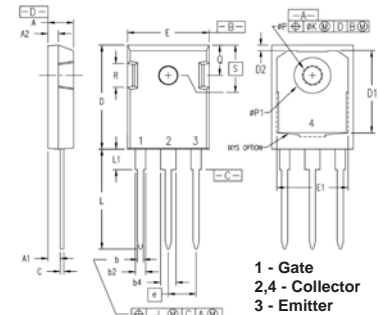

Dim.	Millimeter		Inches	
	min	max	min	max
A	4.70	5.30	0.185	0.209
A1	2.21	2.59	0.087	0.102
A2	1.50	2.49	0.059	0.098
b	0.99	1.40	0.039	0.055
b2	1.65	2.39	0.065	0.094
b4	2.59	3.43	0.102	0.135
c	0.38	0.89	0.015	0.035
D	20.79	21.45	0.819	0.845
D1	13.07	-	0.515	-
D2	0.51	1.35	0.020	0.053
E	15.48	16.24	0.610	0.640
E1	13.45	-	0.53	-
E2	4.31	5.48	0.170	0.216
e	5.45 BSC		0.215 BSC	
L	19.80	20.30	0.078	0.800
L1	-	4.49	-	0.177
Ø P	3.55	3.65	0.140	0.144
Ø P1	-	7.39	-	0.290
Q	5.38	6.19	0.212	0.244
S	6.14 BSC		0.242 BSC	

Fig. 1. Output Characteristics @  $T_J = 25^\circ\text{C}$

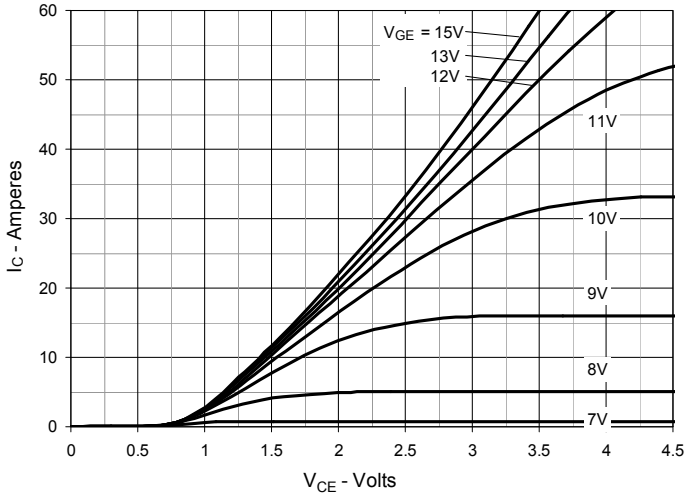

Fig. 2. Extended Output Characteristics @  $T_J = 25^\circ\text{C}$

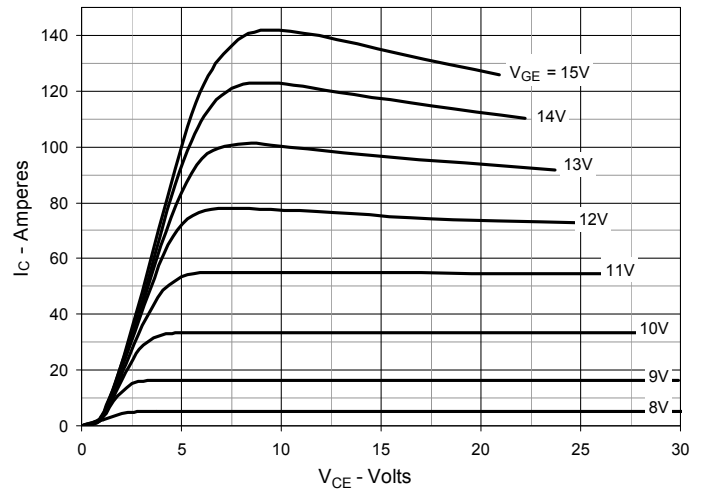

Fig. 3. Output Characteristics @  $T_J = 150^\circ\text{C}$

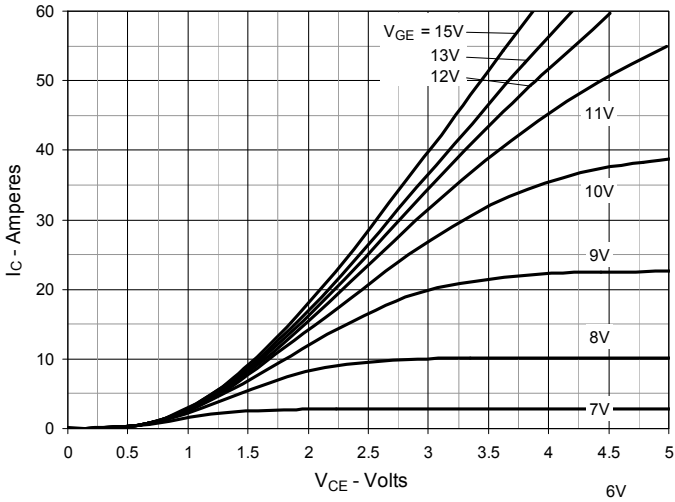

Fig. 4. Dependence of  $V_{CE(sat)}$  on Junction Temperature

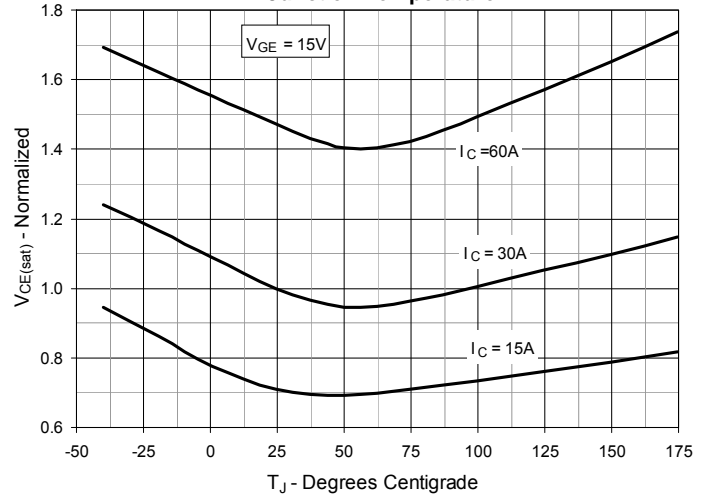

Fig. 5. Collector-to-Emitter Voltage vs. Gate-to-Emitter Voltage

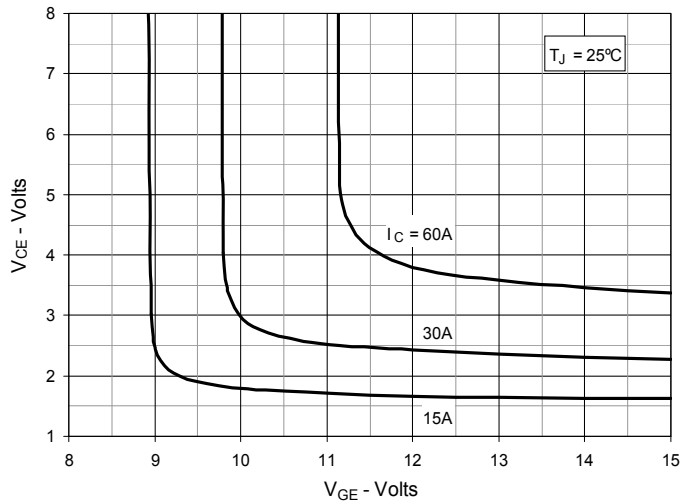

Fig. 6. Input Admittance

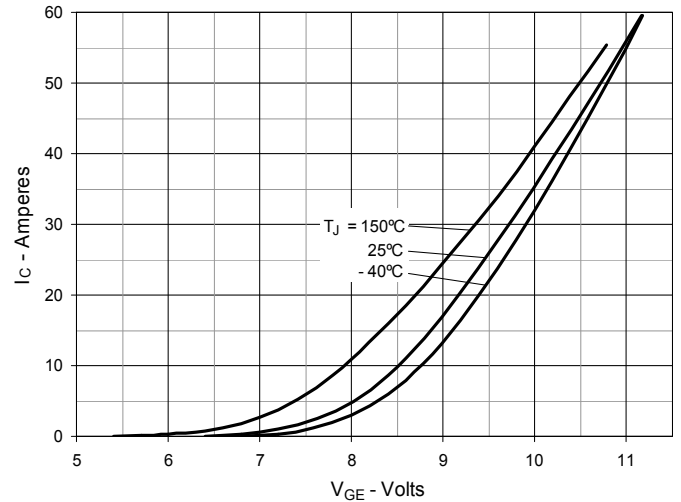

Fig. 7. Transconductance

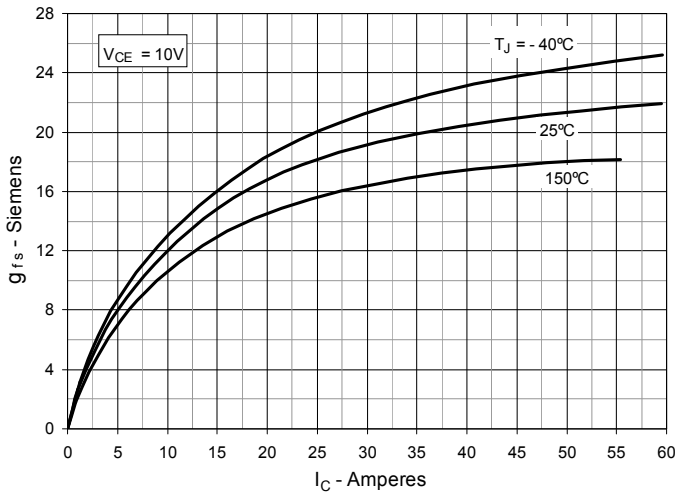

Fig. 8. Gate Charge

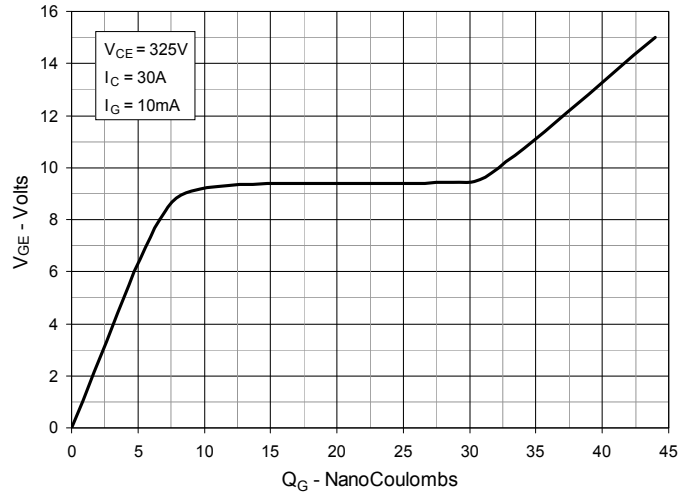

Fig. 9. Capacitance

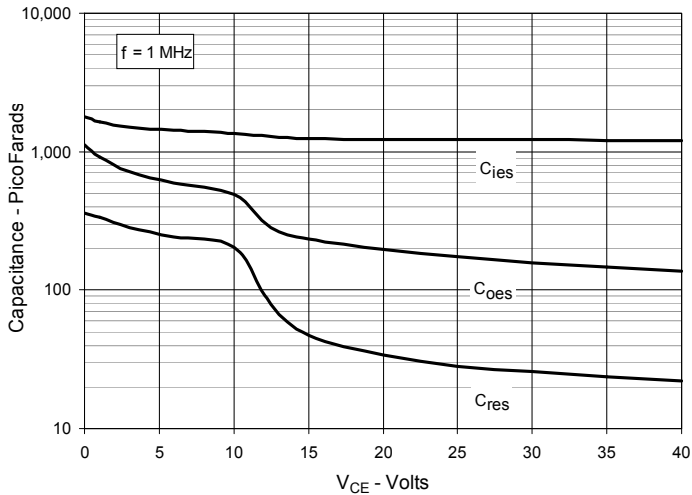

Fig. 10. Reverse-Bias Safe Operating Area

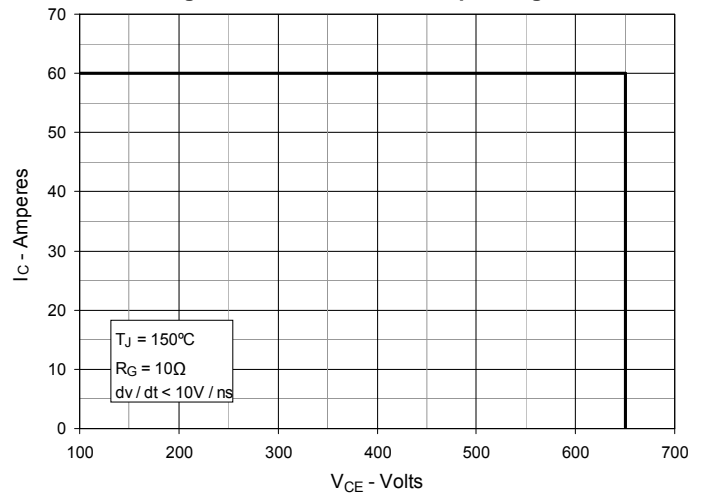
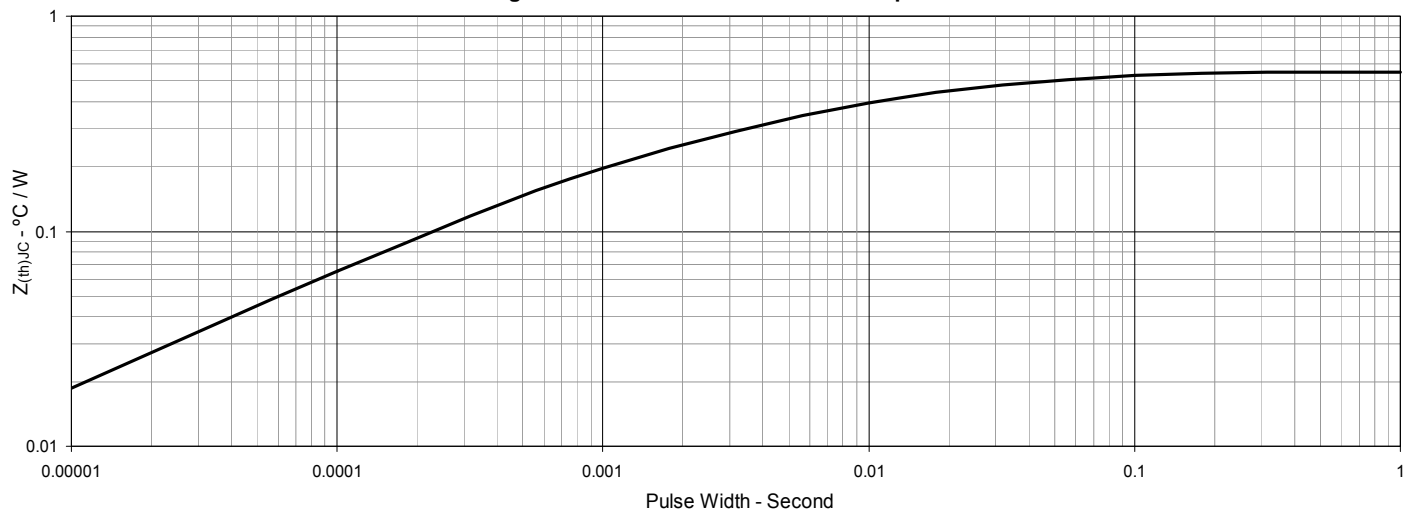
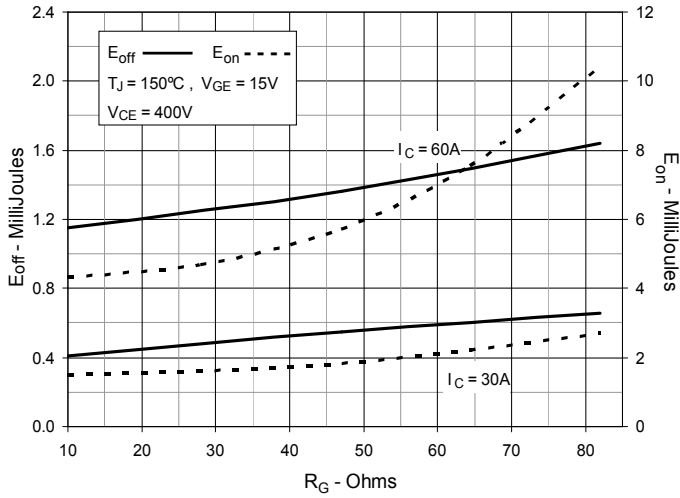

Fig. 11. Maximum Transient Thermal Impedance



**Fig. 12. Inductive Switching Energy Loss vs. Gate Resistance**



**Fig. 13. Inductive Switching Energy Loss vs. Collector Current**

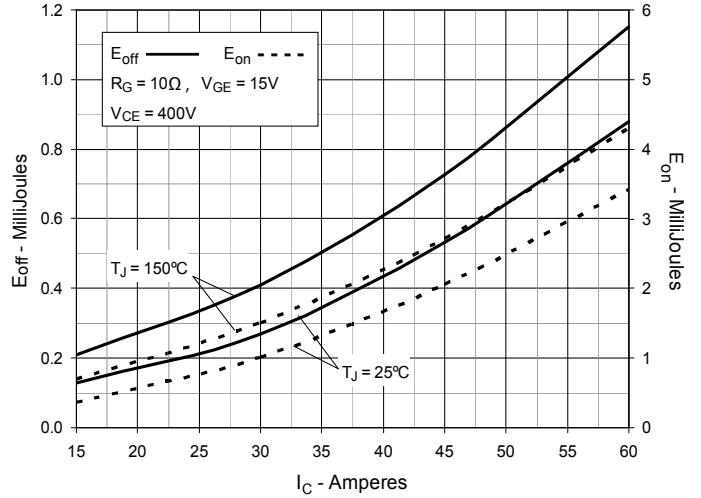

**Fig. 14. Inductive Switching Energy Loss vs. Junction Temperature**

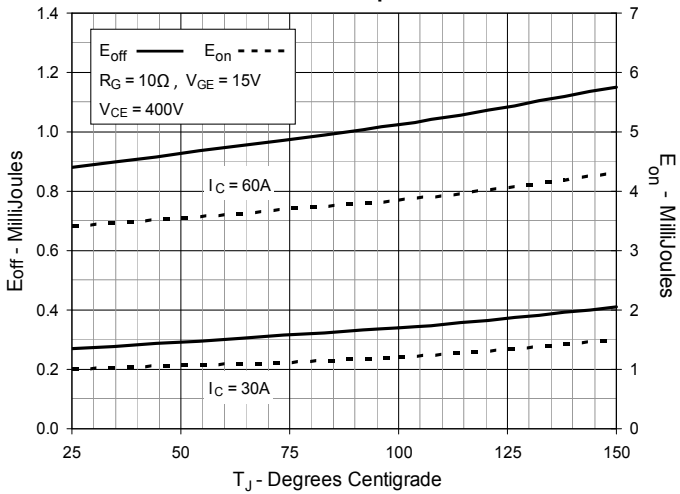

**Fig. 15. Inductive Turn-off Switching Times vs. Gate Resistance**

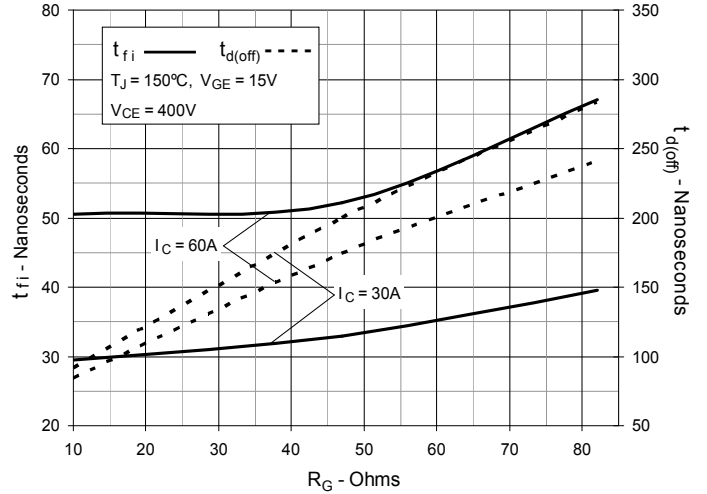

**Fig. 16. Inductive Turn-off Switching Times vs. Collector Current**

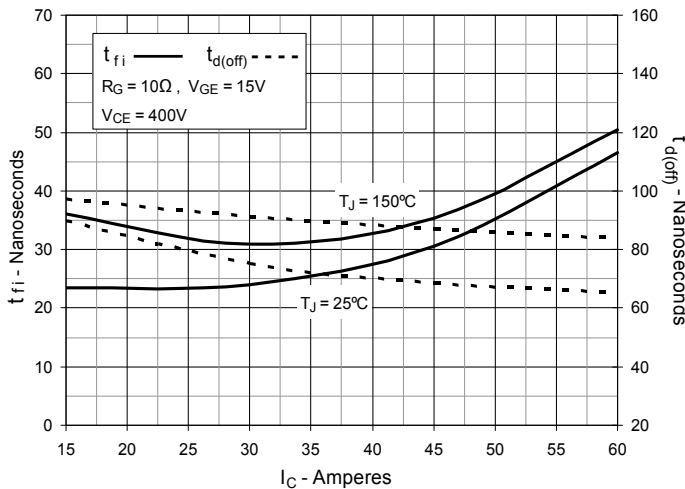

**Fig. 17. Inductive Turn-off Switching Times vs. Junction Temperature**

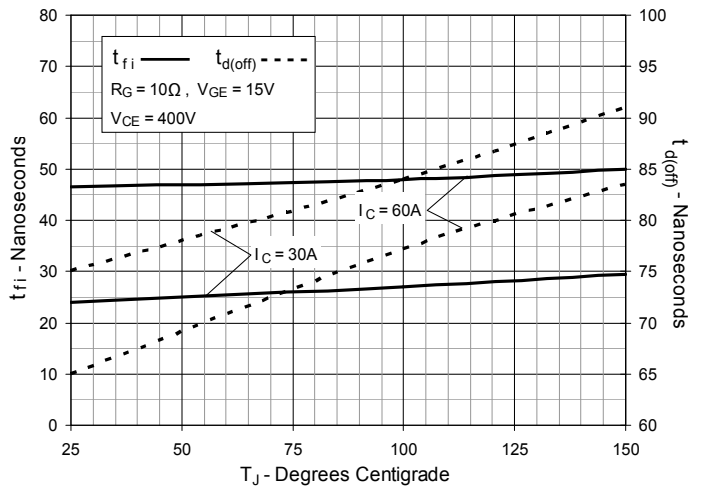

**Fig. 18. Inductive Turn-on Switching Times vs. Gate Resistance**

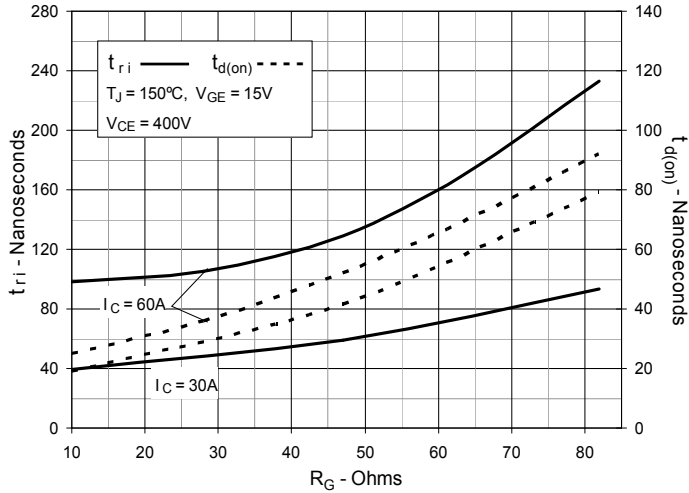

**Fig. 19. Inductive Turn-on Switching Times vs. Collector Current**

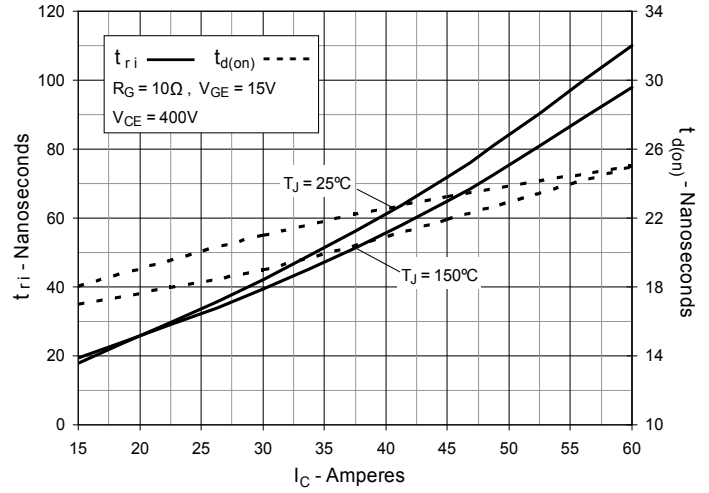

**Fig. 20. Inductive Turn-on Switching Times vs. Junction Temperature**

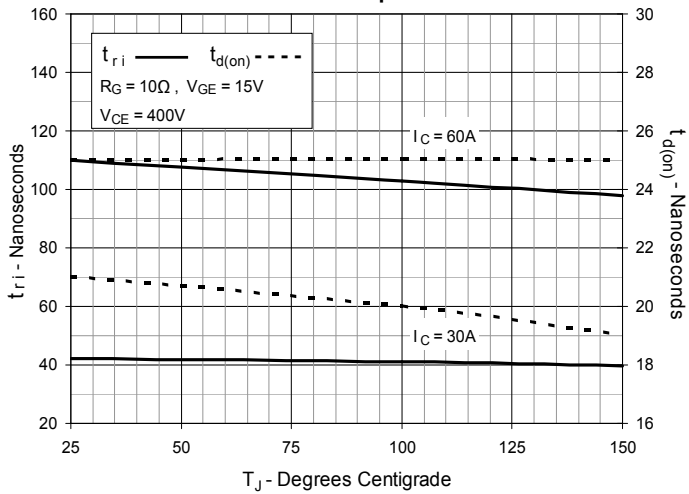

**Fig. 21. Maximum Peak Load Current vs. Frequency**

