

N-Channel JFETs

J108	SST108
J109	SST109
J110	SST110

PRODUCT SUMMARY				
Part Number	V_{GS(off)} (V)	r_{DS(on)} Max (Ω)	I_{D(off)} Typ (pA)	t_{ON} Typ (ns)
J/SST108	-3 to -10	8	20	4
J/SST109	-2 to -6	12	20	4
J/SST110	-0.5 to -4	18	20	4

FEATURES

- Low On-Resistance: J108 <8 Ω
- Fast Switching—t_{ON}: 4 ns
- Low Leakage: 20 pA
- Low Capacitance: 11 pF
- Low Insertion Loss

BENEFITS

- Low Error Voltage
- High-Speed Analog Circuit Performance
- Negligible “Off-Error” Excellent Accuracy
- Good Frequency Response
- Eliminates Additional Buffering

APPLICATIONS

- Analog Switches
- Choppers
- Sample-and-Hold
- Normally “On” Switches
- Current Limiters

DESCRIPTION

The J/SST108 series is designed with high-performance analog switching applications in mind. It features low on-resistance, good off-isolation, and fast switching.

The SST108 series is comprised of surface-mount devices featuring the lowest r_{DS(on)} of any TO-236 (SOT-23) JFET device.

The TO-226AA (TO-92) plastic package provides a low-cost option. Both the J and SST series are available in tape-and-reel for automated assembly (see Packaging Information). For similar products packaged in TO-206AC (TO-52), see the 2N5432/5433/5434 data sheet.

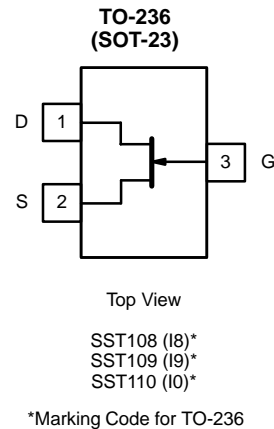
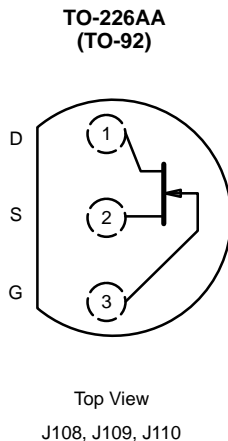



ABSOLUTE MAXIMUM RATINGS

Gate-Drain, Gate-Source Voltage -25 V
 Gate Current 50 mA
 Lead Temperature ($1/16''$ from case for 10 sec.) 300°C
 Storage Temperature -55 to 150°C

Operating Junction Temperature -55 to 150°C
 Power Dissipation^a 350 mW

Notes

a. Derate 2.8 mW/°C above 25°C

SPECIFICATIONS ($T_A = 25^\circ\text{C}$ UNLESS OTHERWISE NOTED)										
Parameter	Symbol	Test Conditions	Typ ^a	Limits						Unit
				J/SST108		J/SST109		J/SST110		
				Min	Max	Min	Max	Min	Max	
Static										
Gate-Source Breakdown Voltage	$V_{(BR)GSS}$	$I_G = -1 \mu\text{A}, V_{DS} = 0 \text{ V}$	-32	-25		-25		-25		V
Gate-Source Cutoff Voltage	$V_{GS(off)}$	$V_{DS} = 5 \text{ V}, I_D = 1 \mu\text{A}$		-3	-10	-2	-6	-0.5	-4	
Saturation Drain Current ^b	I_{DSS}	$V_{DS} = 15 \text{ V}, V_{GS} = 0 \text{ V}$		80		40		10		mA
Gate Reverse Current	I_{GSS}	$V_{GS} = -15 \text{ V}, V_{DS} = 0 \text{ V}$	-0.01		-3		-3		-3	nA
Gate Operating Current	I_G	$V_{DG} = 10 \text{ V}, I_D = 10 \text{ mA}$	-0.01							
Drain Cutoff Current	$I_{D(off)}$	$V_{DS} = 5 \text{ V}, V_{GS} = -10 \text{ V}$	0.02		3		3		3	
Drain-Source On-Resistance	$r_{DS(on)}$	$V_{GS} = 0 \text{ V}, V_{DS} \leq 0.1 \text{ V}$			8		12		18	Ω
Gate-Source Forward Voltage	$V_{GS(F)}$	$I_G = 1 \text{ mA}, V_{DS} = 0 \text{ V}$	0.7							V
Dynamic										
Common-Source Forward Transconductance	g_{fs}	$V_{DS} = 5 \text{ V}, I_D = 10 \text{ mA}, f = 1 \text{ kHz}$	17							mS
Common-Source Output Conductance	g_{os}		0.6							
Drain-Source On-Resistance	$r_{ds(on)}$	$V_{GS} = 0 \text{ V}, I_D = 0 \text{ mA}, f = 1 \text{ kHz}$			8		12		18	Ω
Common-Source Input Capacitance	C_{iss}	$V_{DS} = 0 \text{ V}$ $V_{GS} = 0 \text{ V}$ $f = 1 \text{ MHz}$	SST	60						pF
			J Series	60		85		85		
Common-Source Reverse Transfer Capacitance	C_{rss}	$V_{DS} = 0 \text{ V}$ $V_{GS} = -10 \text{ V}$ $f = 1 \text{ MHz}$	SST	11						
			J Series	11		15		15		
Equivalent Input Noise Voltage	\bar{e}_n	$V_{DG} = 5 \text{ V}, I_D = 10 \text{ mA}$ $f = 1 \text{ kHz}$	3.5							nV/ $\sqrt{\text{Hz}}$
Switching										
Turn-On Time	$t_{d(on)}$	$V_{DD} = 1.5 \text{ V}, V_{GS(H)} = 0 \text{ V}$ See Switching Diagram	3							ns
	t_r		1							
Turn-Off Time	$t_{d(off)}$		4							
	t_f		18							

Notes

a. Typical values are for DESIGN AID ONLY, not guaranteed nor subject to production testing.

b. Pulse test: $PW \leq 300 \mu\text{s}$ duty cycle $\leq 3\%$.

NIP



TYPICAL CHARACTERISTICS (T_A = 25°C UNLESS OTHERWISE NOTED)

On-Resistance and Drain Current vs. Gate-Source Cutoff Voltage

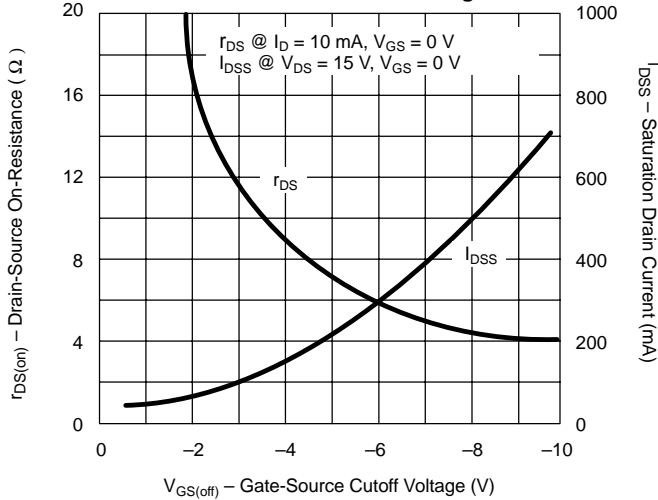

On-Resistance vs. Drain Current

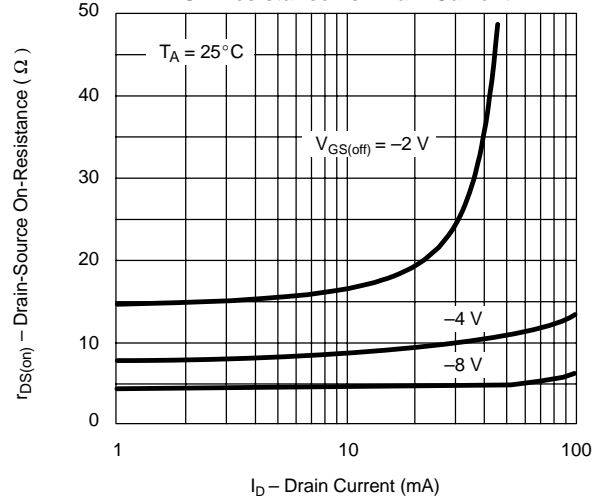

On-Resistance vs. Temperature

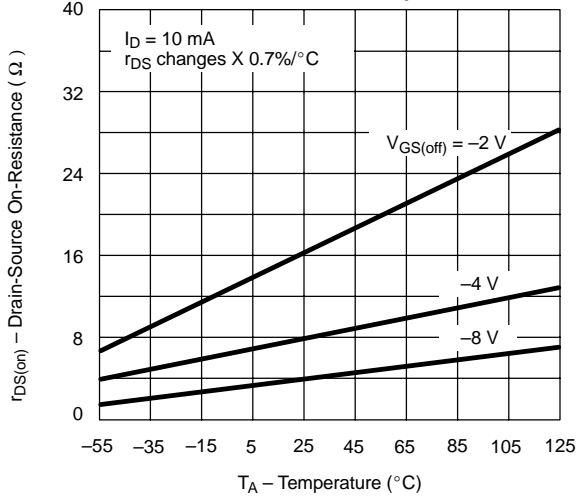

Output Characteristics

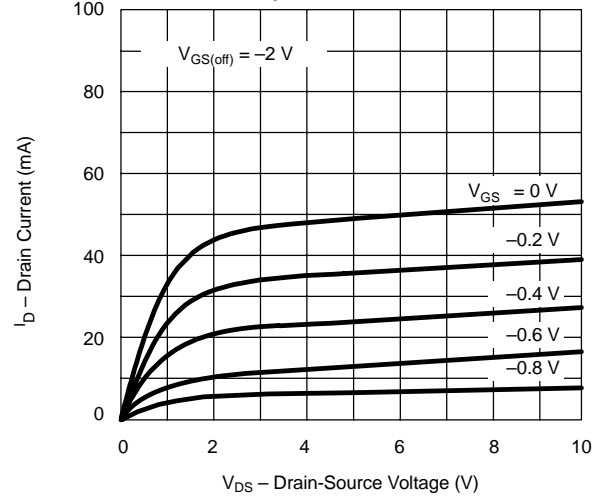

Turn-On Switching

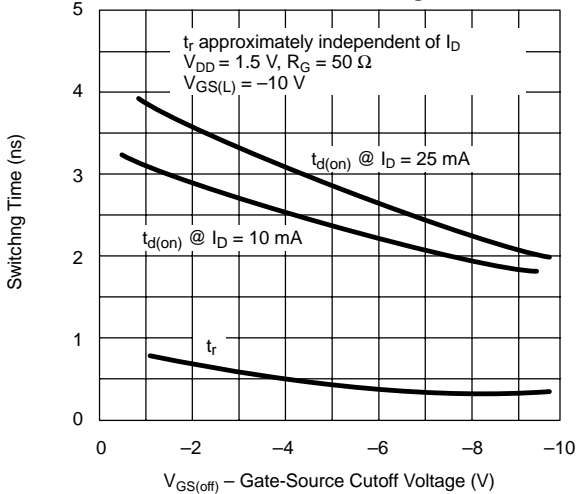

Turn-Off Switching

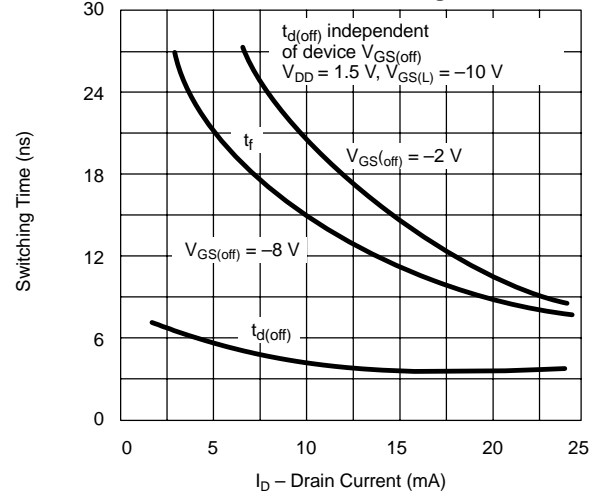



TYPICAL CHARACTERISTICS ($T_A = 25^\circ\text{C}$ UNLESS OTHERWISE NOTED)

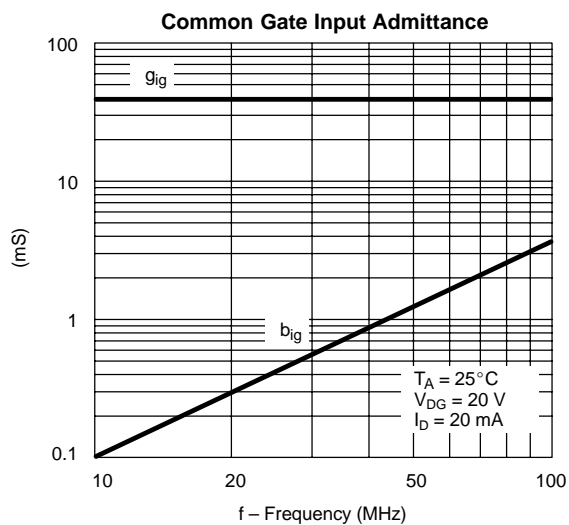
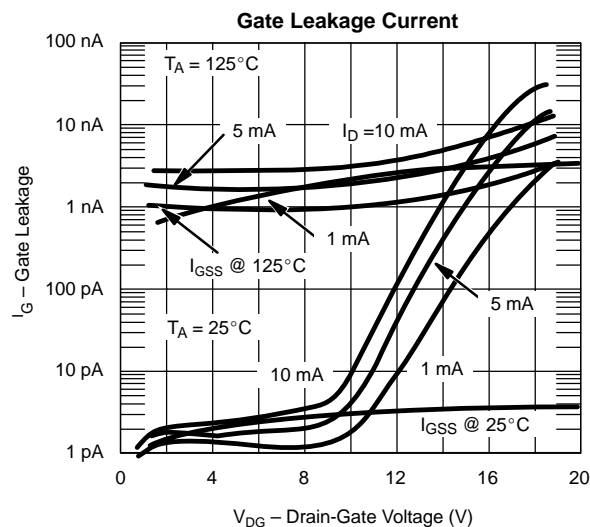
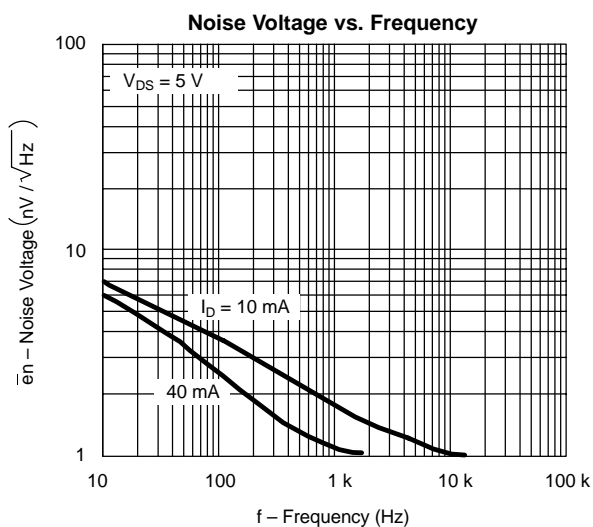
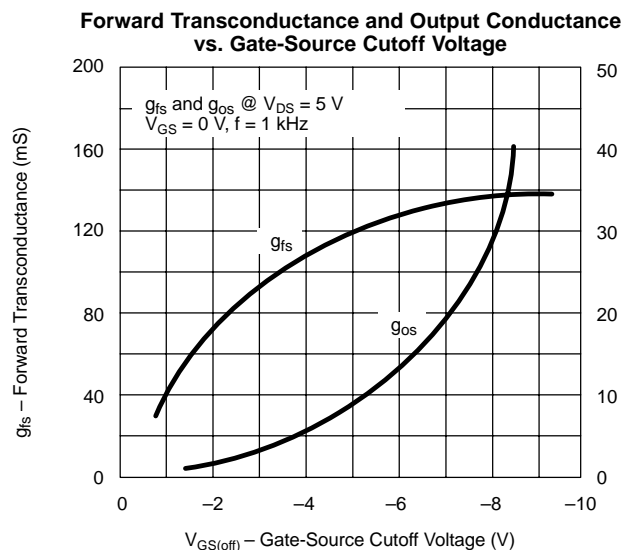
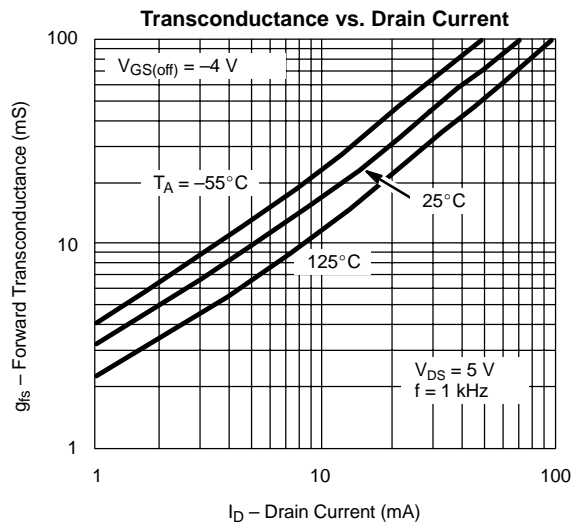
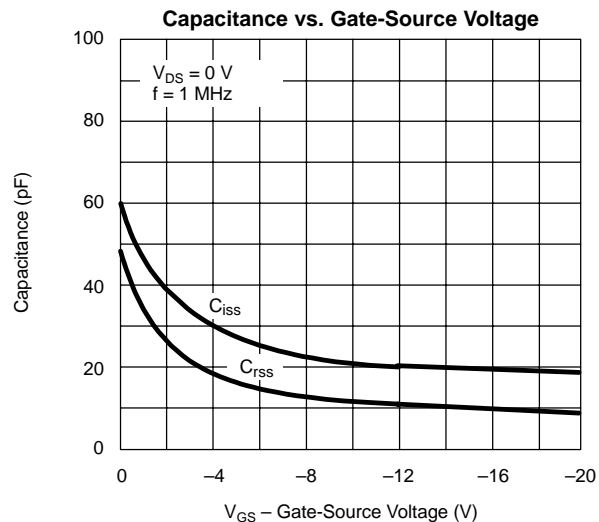



TYPICAL CHARACTERISTICS (T_A = 25°C UNLESS OTHERWISE NOTED)

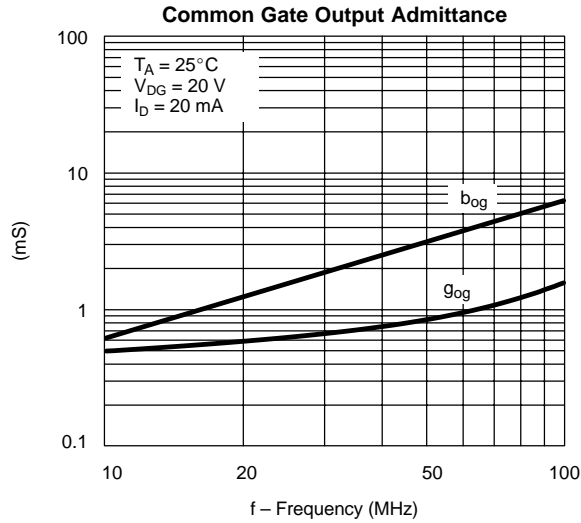
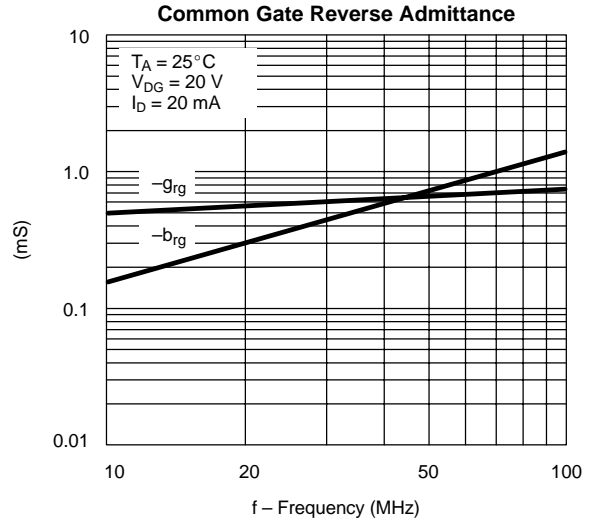
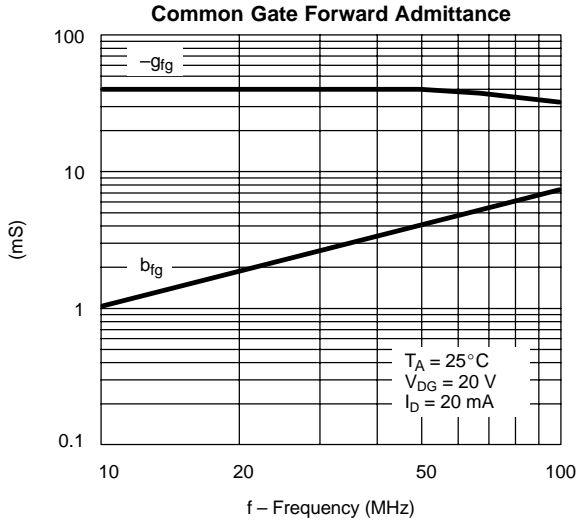

SWITCHING TIME TEST CIRCUIT			
	J/SST108	J/SST109	J/SST110
V _{GS(L)}	-12 V	-7 V	-5 V
R _L *	150 Ω	150 Ω	150 Ω
I _{D(on)}	10 mA	10 mA	10 mA

*Non-inductive

INPUT PULSE

Rise Time < 1 ns
Fall Time < 1 ns
Pulse Width 100 ns
PRF 1 MHz

SAMPLING SCOPE

Rise Time 0.4 ns
Input Resistance 10 MΩ
Input Capacitance 1.5 pF

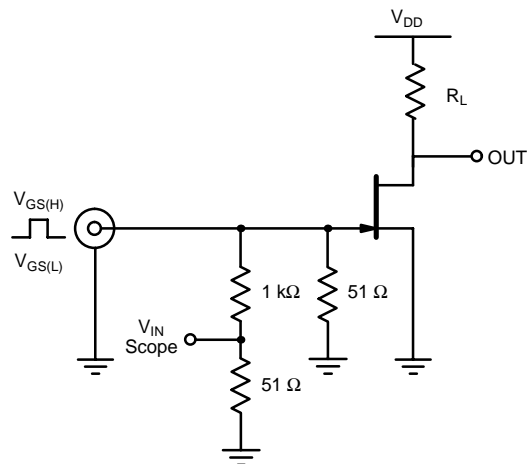



Disclaimer

All product specifications and data are subject to change without notice.

Vishay Intertechnology, Inc., its affiliates, agents, and employees, and all persons acting on its or their behalf (collectively, "Vishay"), disclaim any and all liability for any errors, inaccuracies or incompleteness contained herein or in any other disclosure relating to any product.

Vishay disclaims any and all liability arising out of the use or application of any product described herein or of any information provided herein to the maximum extent permitted by law. The product specifications do not expand or otherwise modify Vishay's terms and conditions of purchase, including but not limited to the warranty expressed therein, which apply to these products.

No license, express or implied, by estoppel or otherwise, to any intellectual property rights is granted by this document or by any conduct of Vishay.

The products shown herein are not designed for use in medical, life-saving, or life-sustaining applications unless otherwise expressly indicated. Customers using or selling Vishay products not expressly indicated for use in such applications do so entirely at their own risk and agree to fully indemnify Vishay for any damages arising or resulting from such use or sale. Please contact authorized Vishay personnel to obtain written terms and conditions regarding products designed for such applications.

Product names and markings noted herein may be trademarks of their respective owners.