

## J176, J177 P-Channel JFET

### Features

- InterFET [P0099F Geometry](#)
- Low noise: 2.0 nV/VHz typical
- High gain: 10mS typical
- Low gate leakage: 2.5pA typical @10V
- Typical  $I_{bss}$ : 10mA
- Typical  $BV_{GSS}$ : -55V
- High radiation tolerance
- RoHS, REACH, CMR compliant
- Custom test and binning options available
- SMT, TH, and bare die package options
- SPICE Edge case modeling: [InterFET SPICE](#)

### Industry Standard Crosses

- SST176, SST177, 2N5116, SST270, SST271

### InterFET Similar Parts

- 2N5019, 2N5114, 2N5115, 2N5116
- P1086, P1087, J270, J271, VCR3P
- IFN3993, IFN3994, U304, U305, U306

SOT23 Top View

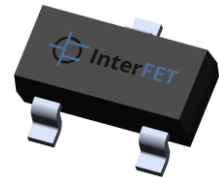
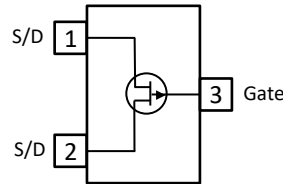

TO-92 Bottom View

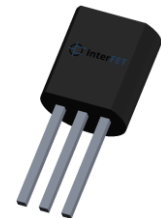
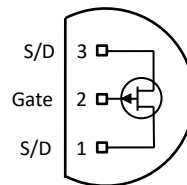

NOTE: S/D pins are interchangeable Source Drain connections

### Applications

- General: Amplifiers; Switches; Voltage regulators; Oscillators; Signal mixers; Noise generators
- Military/Aero: Radar; Communications; Satellites; Missiles guidance; Hydrophone preamplifiers
- Medical: Medical imaging systems; Medical monitors and recorders; Ultrasound equipment
- Audio: Tone control circuits; Headphone amplifiers; Audio filters; Electret Microphone

### Description

The 30V InterFET J176 and J177 are very low leakage low noise P-channel JFETs targeted for high gain switching, commutator, and chopper applications. Gate leakages are typically less 3pA at room temperatures. The J177 has a cutoff voltage of less than 2.25V ideal for low-level power supplies. Proprietary InterFET processes yield exceptionally high radiation tolerance.

### Ordering Information Custom Part and Binning Options Available

Part Number	Description	Case	Packaging
J176; J177	Through-Hole	TO-92	Bulk
SMPJ176; SMPJ177	Surface Mount	SOT23	Bulk
SMPJ176TR; SMPJ177TR	7" Tape and Reel: Max 3,000 Pieces 13" Tape and Reel: Max 9,000 Pieces	SOT23	Minimum 1,000 Pieces Tape and Reel
J176COT; J177COT	Chip Orientated Tray (COT Waffle Pack)	COT	400/Waffle Pack
J176CFT; J177CFT	Chip Face-up Tray (CFT Waffle Pack)	CFT	400/Waffle Pack



**NOTICE:** Please refer to the end of this document for information on product materials, compliance, safety, and legal statements.

## Electrical Characteristics

### Maximum Ratings (@ T<sub>A</sub> = 25°C, Unless otherwise specified)

Parameters	SOT-23	TO-92	Unit
V <sub>RGS</sub> Reverse Gate Source and Gate Drain Voltage	-20	-20	V
I <sub>FG</sub> Continuous Forward Gate Current	50	50	mA
P <sub>D</sub> Continuous Device Power Dissipation <sup>1</sup>	350	500	mW
P Power Derating <sup>1</sup>	2.8	4	mW/°C
T <sub>J</sub> Operating Junction Temperature	-55 to 150	-55 to 150	°C
T <sub>STG</sub> Storage Temperature	-55 to 150	-55 to 150	°C

<sup>1</sup> Thermal power dissipation and derating values obtained with gate pin (substrate) thermally connected to pad and/or internal layer.

### Static Characteristics (@ T<sub>A</sub> = 25°C, Unless otherwise specified)

Parameters	Conditions	J176		J177		Unit
		Min	Max	Min	Max	
V <sub>(BR)GSS</sub> Gate to Source Breakdown Voltage	V <sub>DS</sub> = 0V, I <sub>G</sub> = 1μA	30		30		V
I <sub>GSS</sub> Gate to Source Reverse Current	V <sub>GS</sub> = 20V, V <sub>DS</sub> = 0V		1		1	nA
V <sub>GS(OFF)</sub> Gate to Source Cutoff Voltage	V <sub>DS</sub> = -15V, I <sub>D</sub> = -10nA	1	4	0.8	2.25	V
I <sub>DSS</sub> Drain to Source Saturation Current	V <sub>GS</sub> = 0V, V <sub>DS</sub> = -15V (Pulsed)	-2	-35	-1.5	-20	mA
I <sub>D(OFF)</sub> Drain Cutoff Current	V <sub>DS</sub> = -15V, V <sub>GS</sub> = 10V		-1		-1	nA

### Dynamic Characteristics (@ T<sub>A</sub> = 25°C, Unless otherwise specified)

Parameters	Conditions	J176		J177		Unit
		Min	Max	Min	Max	
R <sub>DS(ON)</sub> Drain to Source ON Resistance	V <sub>DS</sub> <= 0.1V, V <sub>GS</sub> = 0V, f = 1kHz		250		300	Ω
C <sub>gd</sub> Drain Gate Capacitance	V <sub>DS</sub> = 0V, V <sub>GS</sub> = 10V, f = 1MHz	5.5 (typ)		5.5 (typ)		pF
C <sub>gs</sub> Input Capacitance	V <sub>DS</sub> = 0V, V <sub>GS</sub> = 10V, f = 1MHz	5.5 (typ)		5.5 (typ)		pF
C <sub>gd</sub> + C <sub>gs</sub> Drain + Source Gate Capacitance	V <sub>DS</sub> = V <sub>GS</sub> = 0V, f = 1MHz	32 (typ)		32 (typ)		pF
t <sub>d(ON)</sub> Turn ON Delay Time	V <sub>DD</sub> = -6V J176: V <sub>GS(OFF)</sub> = 6V, R <sub>L</sub> = 5600 Ω J177: V <sub>GS(OFF)</sub> = 3V, R <sub>L</sub> = 10000 Ω	15 (typ)		20 (typ)		ns
t <sub>r</sub> Rise Time		20 (typ)		25 (typ)		ns
t <sub>d(OFF)</sub> Turn OFF Delay Time		15 (typ)		20 (typ)		ns
t <sub>f</sub> Fall Time		20 (typ)		25 (typ)		ns

### Typical J176, J177 Characteristics

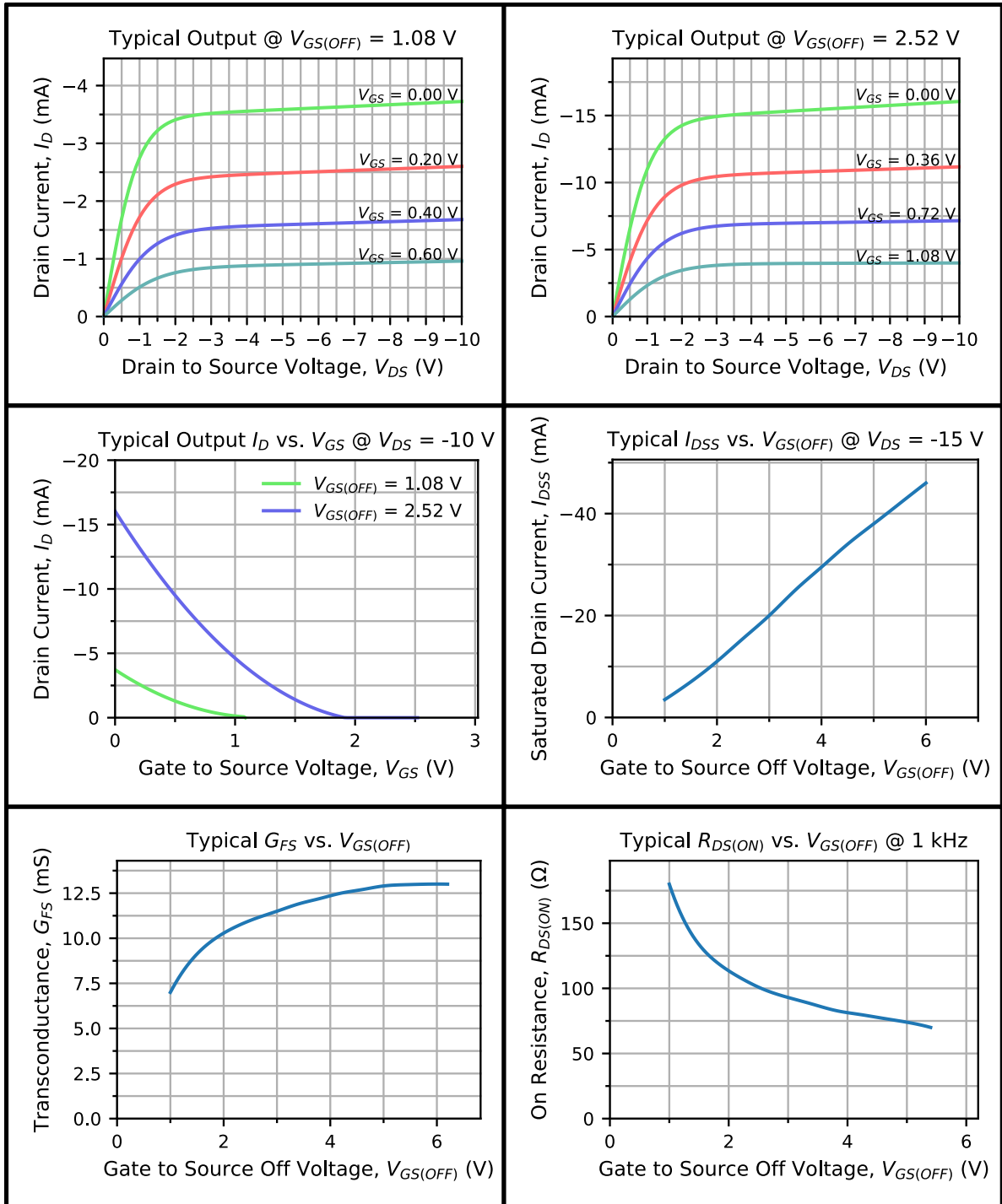

**Typical J176, J177 Characteristics (Continued)**

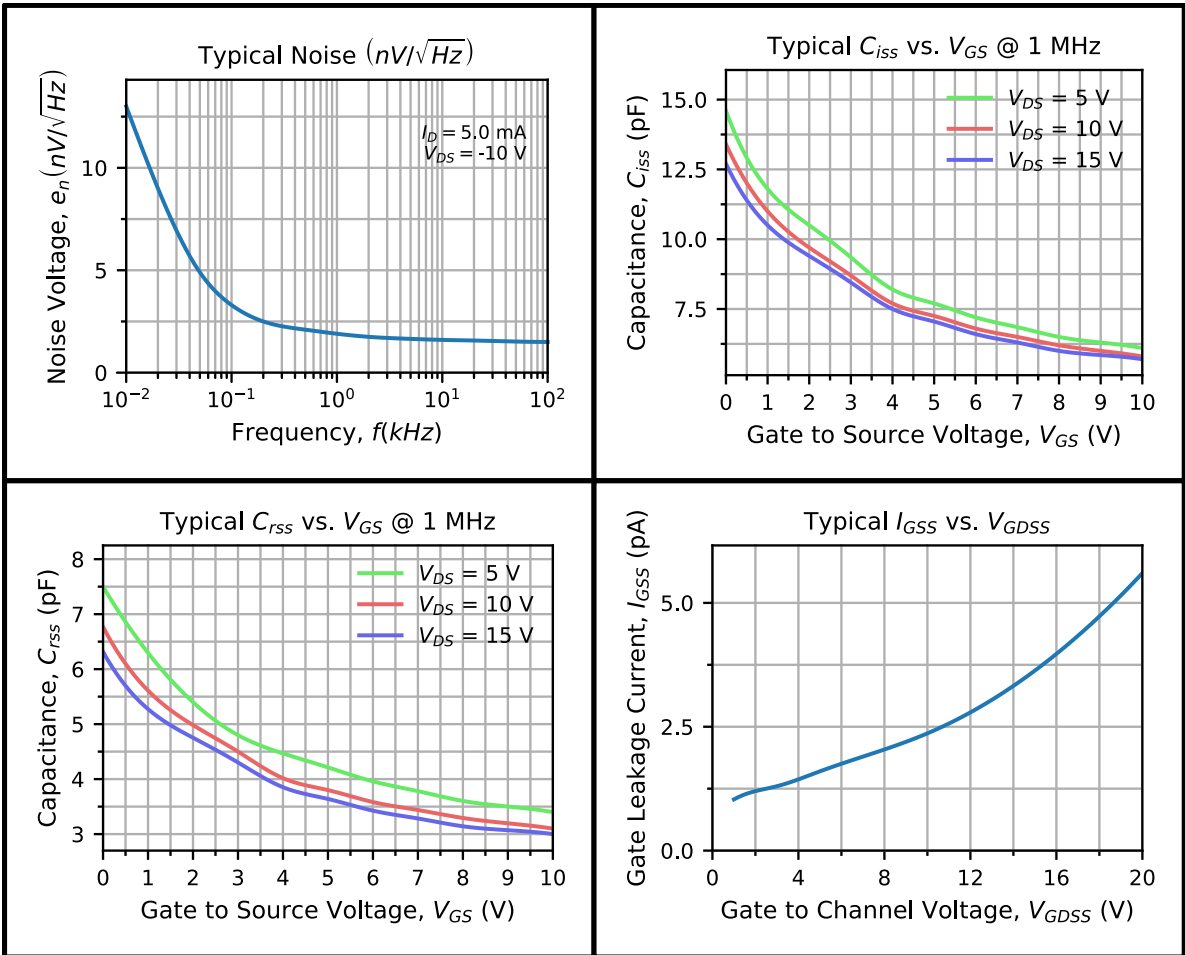

## SOT23 (TO-236AB) Mechanical and Layout Data

### Package Outline Data



1. All linear dimensions are in millimeters.
2. Package weight approximately 0.12 grams
3. Molded plastic case UL 94V-0 rated
4. For Tape and Reel specifications refer to InterFET CTC-021 Tape and Reel Specification, Document number: IF39002
5. Bulk product is shipped in standard ESD shipping material
6. Refer to JEDEC standards for additional information.

### Suggested Pad Layout



1. All linear dimensions are in millimeters.
2. The suggested land pattern dimensions have been provided for reference only. A more robust pattern may be desired for wave soldering.

## TO-92 Mechanical and Layout Data

### Package Outline Data

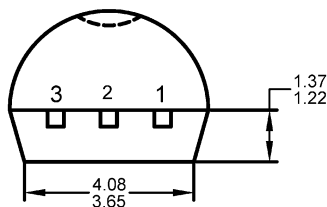
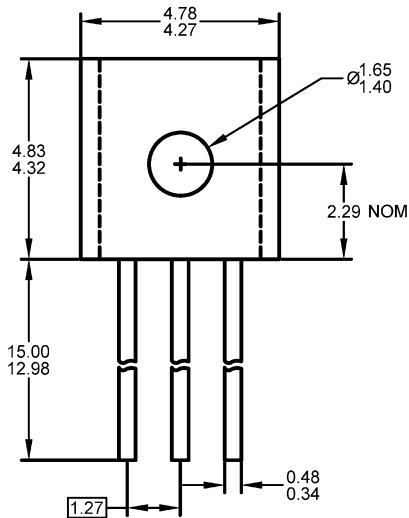

1. All linear dimensions are in millimeters.
2. Package weight approximately 0.19 grams
3. Molded plastic case UL 94V-0 rated
4. Bulk product is shipped in standard ESD shipping material
5. Refer to JEDEC standards for additional information.

### Suggested Through-Hole Layout

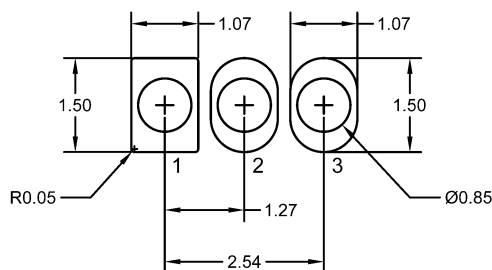

1. All linear dimensions are in millimeters.
2. The suggested land pattern dimensions have been provided as a straight lead reference only. A more robust pattern may be desired for wave soldering and/or bent lead configurations.

## Compliance and Legal

### Environment

InterFET parts follow the latest RoHS Compliance, REACH Compliance, Proposition 65 Statement, TSCA Statement, and Chemical Disposal and Waste Mitigation requirement and guidelines. For more on InterFET’s Environmental Commitment please visit [www.InterFET.com/environmental/](http://www.InterFET.com/environmental/).

### Package materials

Parameters	SOT23	SOIC8	TO-92	Metal Case
Alloy	CDA194	C194 1/2H	C194 1/2H	Kovar
Cu	Balance	97% min	97% min	
Fe	2.1 – 2.6%	2.1 – 2.6%	2.1 – 2.6%	53%
Zn	0.05 – 0.2%	0.05 – 0.2%	0.05 – 0.15%	
P	0.015 – 0.15%	0.015 – 0.15%	0.015 – 0.15%	
Pb	0.03% max	0.03% max	0.03% max	
Ni				29%
Co				17%
Mn				0.3%
Si				0.2%
C				<0.01%
Au				Plating

### Package tests

Parameters	SOT23	SOIC8	TO-92	Metal Case
MSL	Level 1	Level 2	N/A	N/A
ESD	Class M4 Machine Model Class 3B HBM	Class M4 Machine Model Class 3B HBM	Class M4 Machine Model Class 3B HBM	Class M4 Machine Model Class 3B HBM

### Legal Notice

InterFET Corporation reserves the right to make corrections, enhancements, improvements, modifications, and other changes to its semiconductor products without further notice to this document and any product described herein. InterFET does not assume any liability arising out of the application or use of this document or any product described herein. Unless InterFET has explicitly designated an individual product as meeting the requirements of a particular industry standard, InterFET is not responsible for any failure to meet such industry standard requirements.

InterFET Corporation assumes no liability for a customers product design or applications. Corporate designers and others who are developing systems that incorporate InterFET products understand and agree that they remain responsible for using their independent analysis, evaluation and judgment in designing their applications. Corporate designers and others have full and exclusive responsibility to assure the safety of Designers’ applications and compliance of their applications with all applicable regulations, laws and other applicable requirements.

InterFET Corporation resources are provided “as is” with potential faults. InterFET disclaims all other warranties or representations, express or implied, regarding resources or use thereof, including but not limited to accuracy or completeness, title, any widespread failure warranty and any implied warranties of merchantability, fitness for a particular purpose, and non-infringement of any third party intellectual property rights. InterFET shall not be liable for and shall not defend or indemnify designer against any claim, including but not limited to any infringement claim that relates to or is based on any combination of products even if described in InterFET resources or otherwise. In no event shall InterFET be liable for any actual, direct, special, collateral, indirect, punitive, incidental, consequential or exemplary damages in connection with or arising out of InterFET resources or use thereof, and regardless of whether InterFET has been advised of the possibility of such damages.