

## FJL6820

### High Voltage Color Display Horizontal Deflection Output

- High Collector-Base Breakdown Voltage :  $V_{CB0} = 1500V$
- Low Saturation Voltage :  $V_{CE(sat)} = 3V$  (Max.)
- For Color Monitor

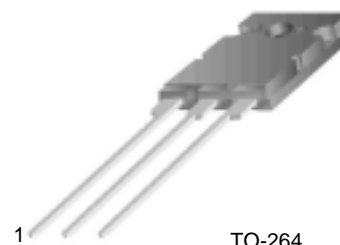

TO-264  
1.Base 2.Collector 3.Emitter

### NPN Triple Diffused Planar Silicon Transistor

#### Absolute Maximum Ratings $T_C=25^\circ C$ unless otherwise noted

Symbol	Parameter	Rating	Units
$V_{CB0}$	Collector-Base Voltage	1500	V
$V_{CEO}$	Collector-Emitter Voltage	750	V
$V_{EBO}$	Emitter-Base Voltage	6	V
$I_C$	Collector Current (DC)	20	A
$I_{CP}^*$	Collector Current (Pulse)	30	A
$P_C$	Collector Dissipation	200	W
$T_J$	Junction Temperature	150	$^\circ C$
$T_{STG}$	Storage Temperature	-55 ~ 150	$^\circ C$

\* Pulse Test:  $PW=300\mu s$ , duty Cycle=2% Pulsed

#### Electrical Characteristics $T_C=25^\circ C$ unless otherwise noted

Symbol	Parameter	Test Conditions	Min.	Typ.	Max.	Units
$I_{CES}$	Collector Cut-off Current	$V_{CB}=1400V, R_{BE}=0$			1	mA
$I_{CBO}$	Collector Cut-off Current	$V_{CB}=800V, I_E=0$			10	$\mu A$
$I_{EBO}$	Emitter Cut-off Current	$V_{EB}=4V, I_C=0$			1	mA
$V_{CB0}$	Collector-Base Breakdown Voltage	$I_C=500\mu A, I_E=0$	1500			V
$V_{CEO}$	Collector-Emitter Breakdown Voltage	$I_C=5mA, I_B=0$	750			V
$V_{EBO}$	Emitter-Base Breakdown Voltage	$I_E=500\mu A, I_C=0$	6			V
$h_{FE1}$	DC Current Gain	$V_{CE}=5V, I_C=1A$	8			
$h_{FE2}$		$V_{CE}=5V, I_C=8.5A$	6		10	
$h_{FE3}$		$V_{CE}=5V, I_C=11A$	5.5		8.5	
$V_{CE(sat)}$	Collector-Emitter Saturation Voltage	$I_C=11A, I_B=2.75A$			3	V
$V_{BE(sat)}$	Base-Emitter Saturation Voltage	$I_C=11A, I_B=2.75A$			1.5	V
$t_{STG}^*$	Storage Time	$V_{CC}=200V, I_C=10A, R_L=20\Omega$			3	$\mu s$
$t_F^*$	Fall Time	$I_{B1}=2.0A, I_{B2}=-4.0A$		0.15	0.2	$\mu s$

\* Pulse Test:  $PW=20\mu s$ , duty Cycle=1% Pulsed

#### Thermal Characteristics $T_C=25^\circ C$ unless otherwise noted

Symbol	Parameter	Typ	Max	Units
$R_{\theta JC}$	Thermal Resistance, Junction to Case		0.625	$^\circ C/W$

# Typical Characteristics

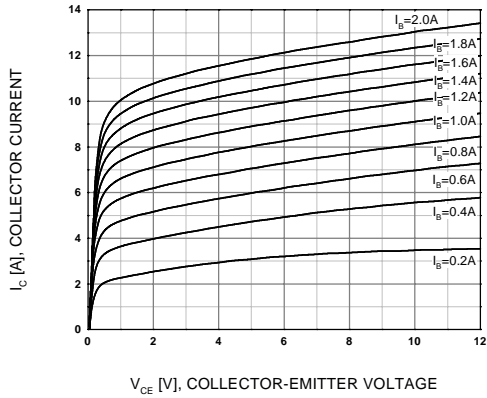

**Figure 1. Static Characteristics**

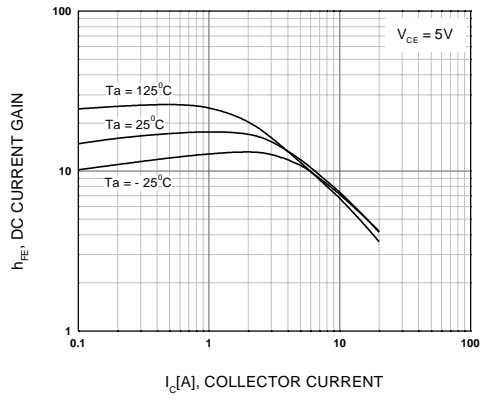

**Figure 2. DC Current Gain**

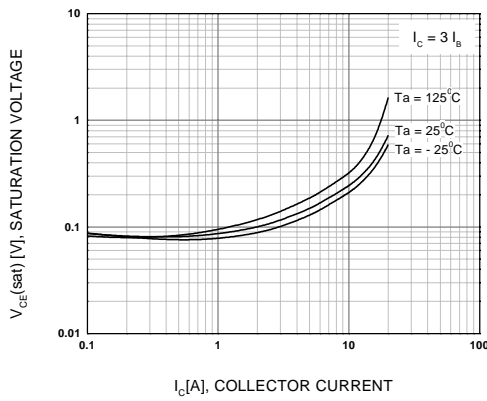

**Figure 3. Collector-Emitter Saturation Voltage**

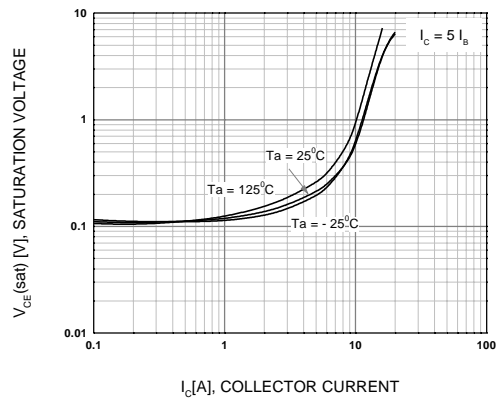

**Figure 4. Collector-Emitter Saturation Voltage**

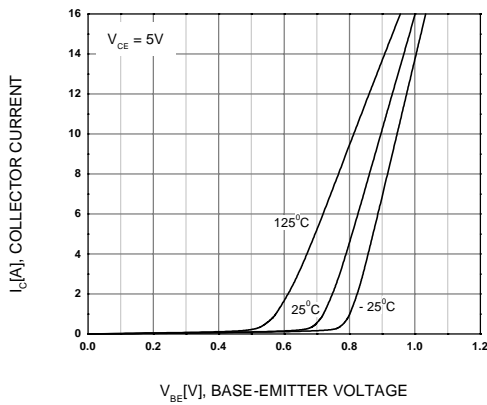

**Figure 5. Base-Emitter On Voltage**

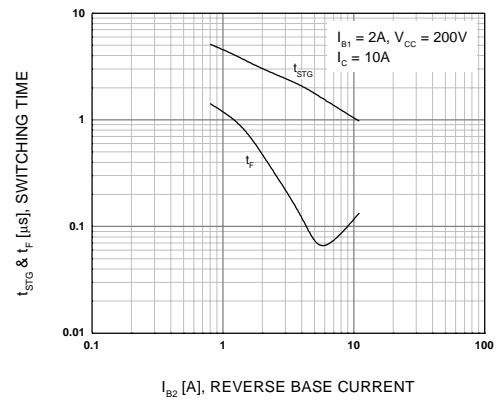

**Figure 6. Resistive Load Switching Time**

## Typical Characteristics (Continued)

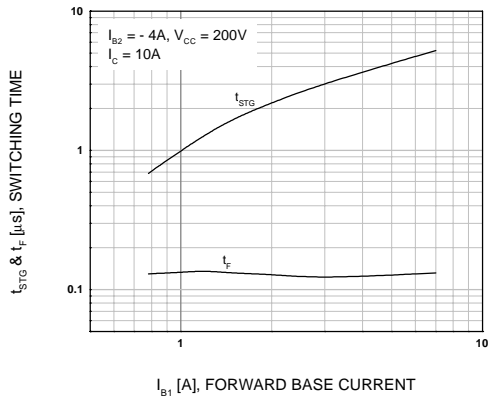

Figure 7. Resistive Load Switching Time

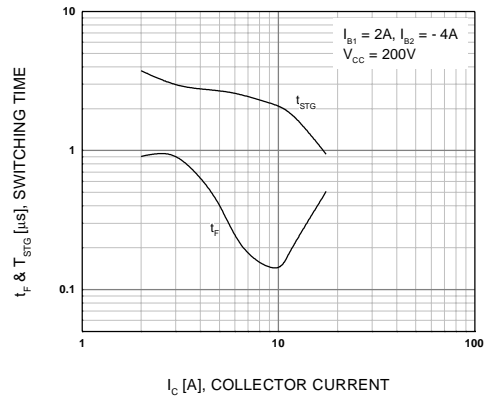

Figure 8. Resistive Load Switching Time

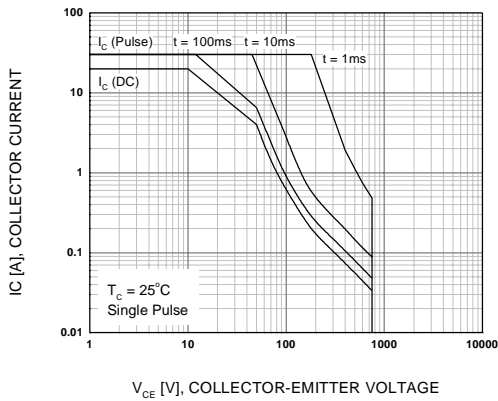

Figure 9. Forward Bias Safe Operating Area

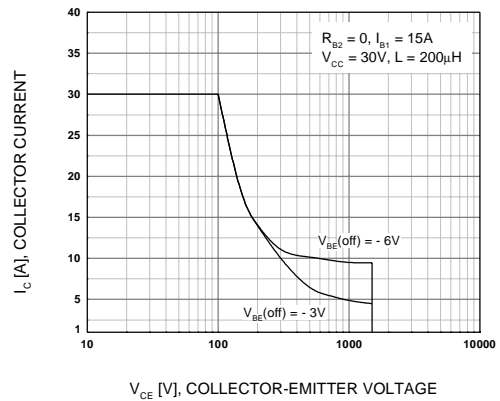

Figure 10. Reverse Bias Safe Operating Area

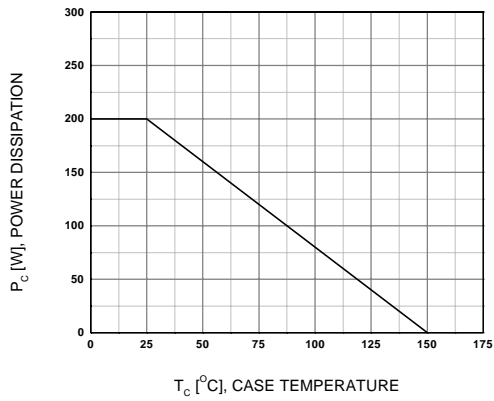
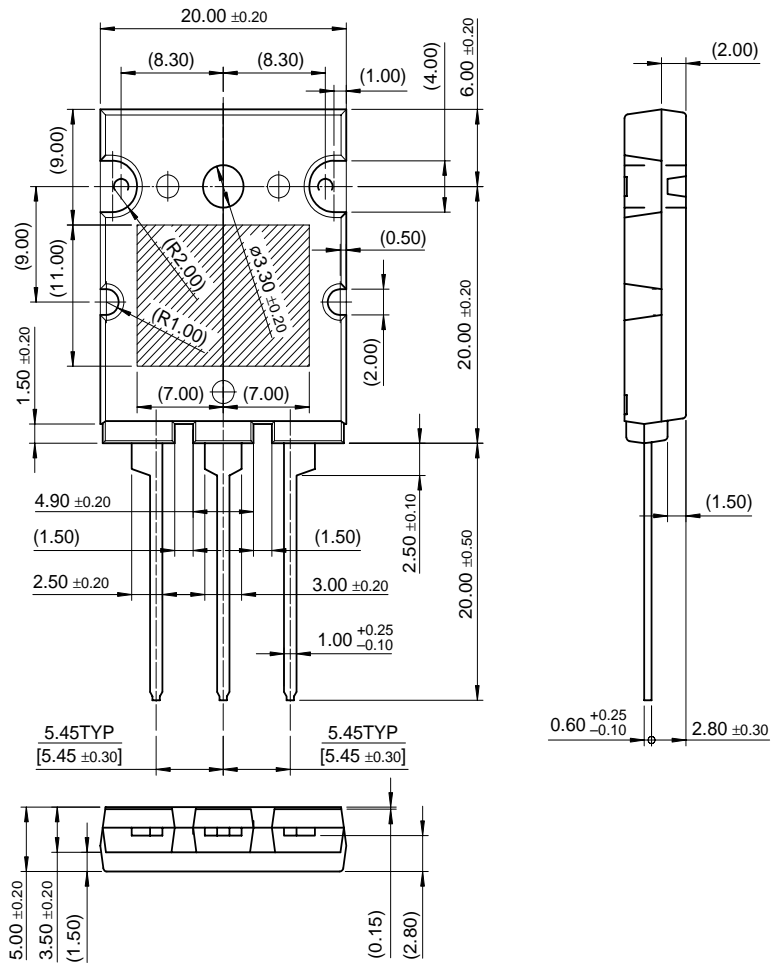

Figure 11. Power Derating

# Package Dimensions

## TO-264



Dimensions in Millimeters

## TRADEMARKS

The following are registered and unregistered trademarks Fairchild Semiconductor owns or is authorized to use and is not intended to be an exhaustive list of all such trademarks.

ACE <sup>x</sup> ™	FAST <sup>®</sup>	OPTOPLANAR™	SuperSOT™-3
Bottomless™	FAST <sup>r</sup> ™	PACMAN™	SuperSOT™-6
CoolFET™	FRFET™	POP™	SuperSOT™-8
CROSSVOLT™	GlobalOptoisolator™	PowerTrench <sup>®</sup>	SyncFET™
DenseTrench™	GTO™	QFET™	TinyLogic™
DOME™	HiSeC™	QS™	UHC™
EcoSPARK™	ISOPLANAR™	QT Optoelectronics™	UltraFET <sup>®</sup>
E <sup>2</sup> CMOS™	LittleFET™	Quiet Series™	VCX™
EnSigna™	MicroFET™	SLIENT SWITCHER <sup>®</sup>	
FACT™	MICROWIRE™	SMART START™	
FACT Quiet Series™	OPTOLOGIC™	Stealth™	

## DISCLAIMER

FAIRCHILD SEMICONDUCTOR RESERVES THE RIGHT TO MAKE CHANGES WITHOUT FURTHER NOTICE TO ANY PRODUCTS HEREIN TO IMPROVE RELIABILITY, FUNCTION OR DESIGN. FAIRCHILD DOES NOT ASSUME ANY LIABILITY ARISING OUT OF THE APPLICATION OR USE OF ANY PRODUCT OR CIRCUIT DESCRIBED HEREIN; NEITHER DOES IT CONVEY ANY LICENSE UNDER ITS PATENT RIGHTS, NOR THE RIGHTS OF OTHERS.

## LIFE SUPPORT POLICY

FAIRCHILD'S PRODUCTS ARE NOT AUTHORIZED FOR USE AS CRITICAL COMPONENTS IN LIFE SUPPORT DEVICES OR SYSTEMS WITHOUT THE EXPRESS WRITTEN APPROVAL OF FAIRCHILD SEMICONDUCTOR CORPORATION.

As used herein:

1. Life support devices or systems are devices or systems which, (a) are intended for surgical implant into the body, or (b) support or sustain life, or (c) whose failure to perform when properly used in accordance with instructions for use provided in the labeling, can be reasonably expected to result in significant injury to the user.
2. A critical component is any component of a life support device or system whose failure to perform can be reasonably expected to cause the failure of the life support device or system, or to affect its safety or effectiveness.

## PRODUCT STATUS DEFINITIONS

### Definition of Terms

Datasheet Identification	Product Status	Definition
Advance Information	Formative or In Design	This datasheet contains the design specifications for product development. Specifications may change in any manner without notice.
Preliminary	First Production	This datasheet contains preliminary data, and supplementary data will be published at a later date. Fairchild Semiconductor reserves the right to make changes at any time without notice in order to improve design.
No Identification Needed	Full Production	This datasheet contains final specifications. Fairchild Semiconductor reserves the right to make changes at any time without notice in order to improve design.
Obsolete	Not In Production	This datasheet contains specifications on a product that has been discontinued by Fairchild semiconductor. The datasheet is printed for reference information only.