



Compact Power Line Shelves

Model: J85480S1, L1 – L14

The 1U (1.75") high CPL family of shelves mount in 19-inch wide frames and provide up to 11kW of 48V output power per shelf. There are three or four slots for rectifiers, converters (PEMs). L1 accepts the CP843A full featured Pulsar controller for applications requiring plant control.

- Only 16.81" wide fits inside equipment that is designed into a 19" rack
- Two DC Outputs may be common or split. Each output bus is rated for 100A with two-hole lug landings for 2 AWG wire.
- Either IEC-320 or AMP Mate_N_Lok AC inputs
- Analog, RS485 or dual/redundant I²C communications.
- Adjustable mounting ears for flush or set back positions.
- Stackable up to 8 high with 32 paralleled power supplies.
- Optional CP843A controller w/display & interactive panel



Rectifier Shelves (AC Input, DC Output)									
List	Max Power	# AC Inputs	AC Input Plug	DC Output Bus	Max Rectifier Size	Communications Features		Ordering Codes	
						Shelf Controller	Protocol		
1	8kW	4	IEC-320, C13	Common	CP2000	CP843A	Analog, I ² C RS485	CC109143723	
4	8kW		IEC-320, C13	Common		No		Analog, I ² C	108994538
6	8kW		AMP Mate_N_Lok	Common			CP2725		Analog, I ² C
7	11kW		AMP Mate_N_Lok	Split	CP2000	Analog, I ² C		CC109121902	
9	8kW		IEC-320, C13	Split					
PEM Shelves (DC Input, DC Output)									
List	Capacity	# DC Inputs	DC Input Plug	DC Output Bus	Max PEM Size	Communications Features		Ordering Codes	
						Controller	Protocol		
14	8kW	2	AMP Power-Blade	Split	CP2000	No	Analog, I ² C	CC109124764	

Notes:

List 1 shelf allows side access to CP843A Pulsar Controller Outputs.

L7, L9: Split Bus Shelves cannot be paralleled. L1, L4, L6: Up to eight shelves may be paralleled.

Consult the factory for product availability

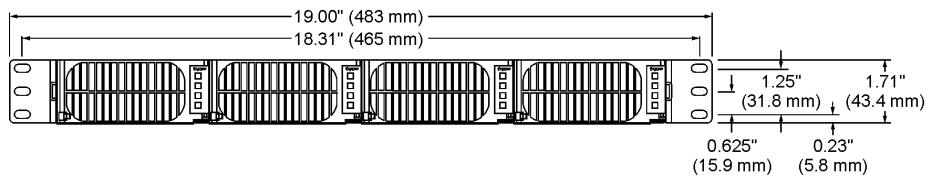
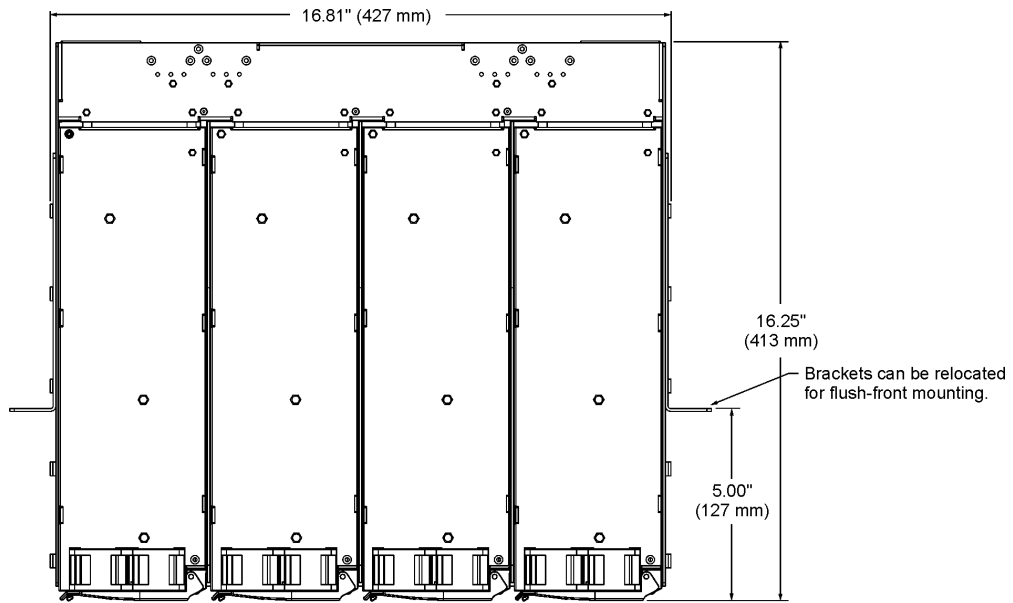

Package Outline

Rear Views

Lists 1, 4, 9

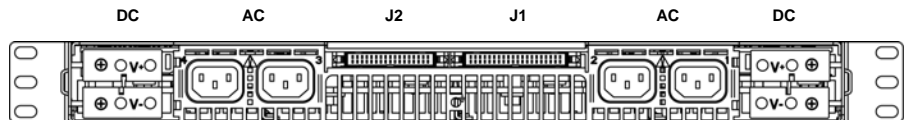

Lists 6, 7

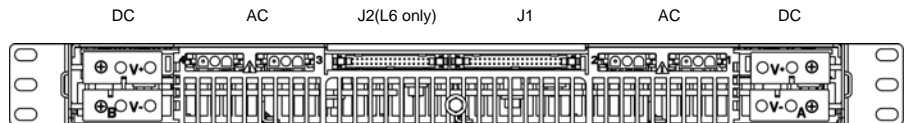

Lists 14

www.DataSheet4U.com

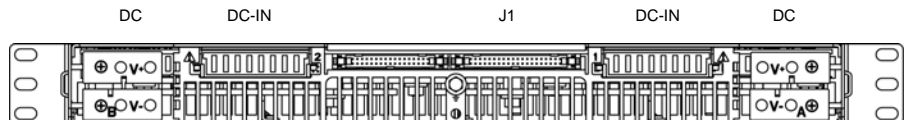

AC Input Connections

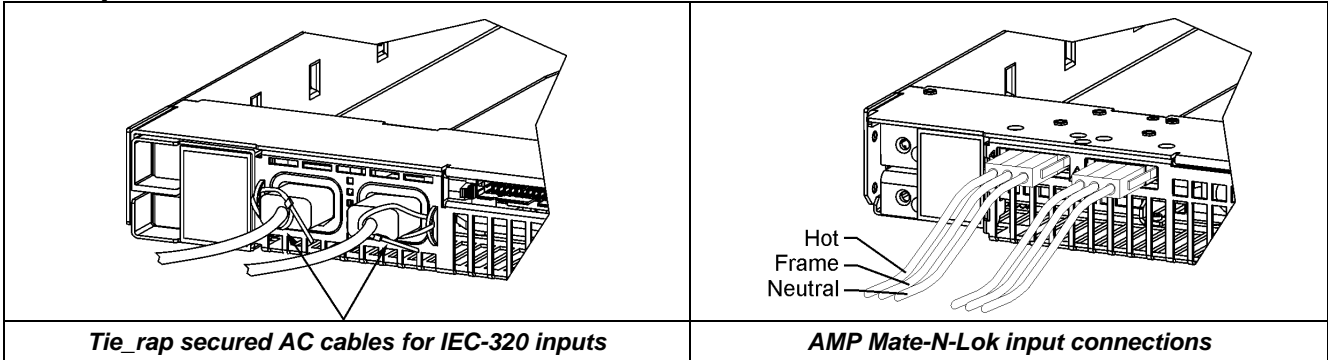

AMP Mate_N_Lok connector piece parts

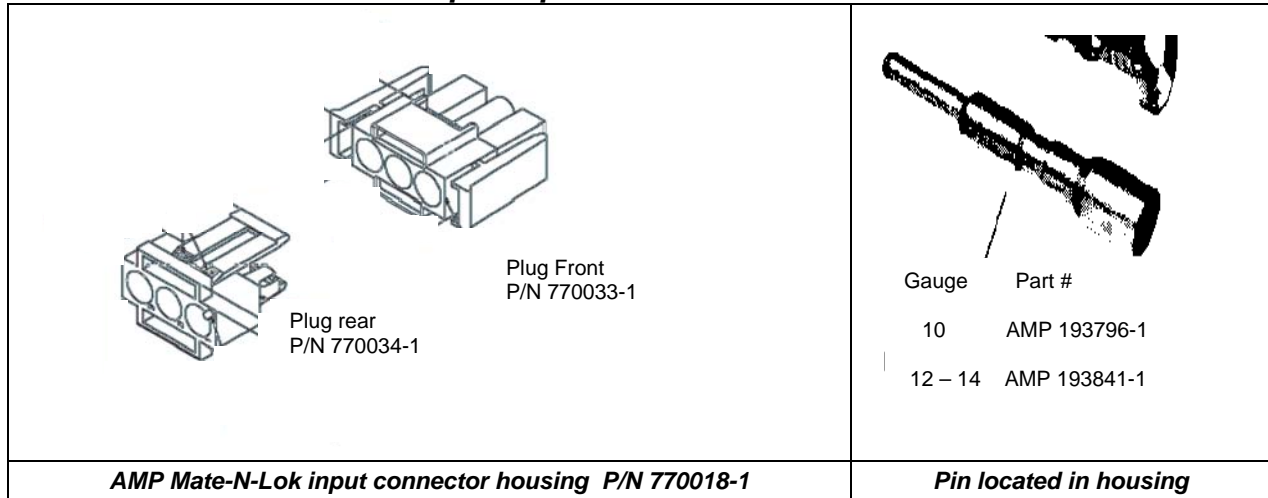

DC Input Connection – L14 shelf

Lineage orderable part #: CC848794908
Includes 4 feet of un-terminated #10ga stranded wires on one end and the AMP multi-beam connector on the other end.

Housing: AMP 1600798-6 multi-beam XL
Contacts: AMP 1-1600960-8
Wire: 10 ga stranded – 30A rated capacity

Pins	Color	Signal	Unit
1 – 2	Black	-48V	1
3 – 4	Red	RTN	
5 – 6	Black	-48V	2
7 – 8	Red	RTN	

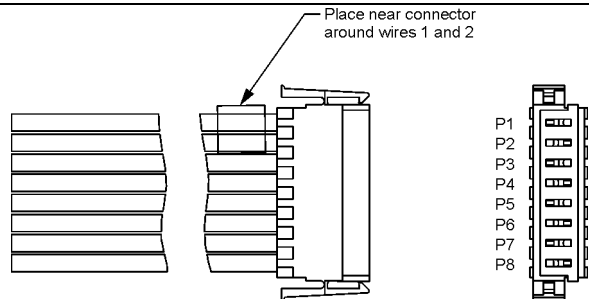

DC Output Connections

- Each Output Bus is rated for 100A and up to 2 gage two-hole lugs.
- M6 nuts with conical washers provided.
- Touch-Safe plastic covers around output buses.

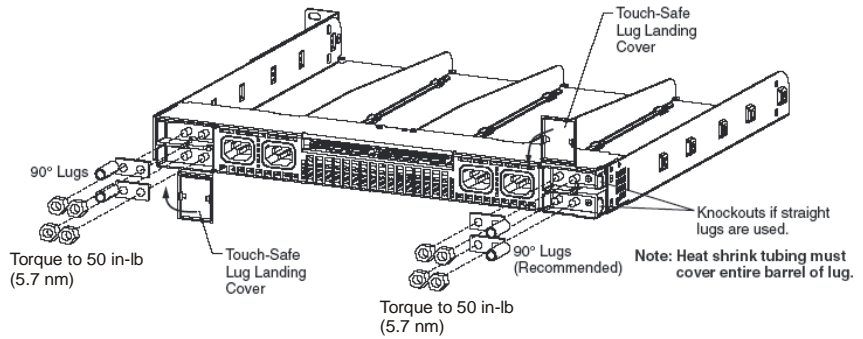

DC Split Output Bus Option

- Split Vout (-) buses on either side of the shelf. Vout (+) is common to both sections.
- +5V bias maintains I²C communications even during a feeder fault.
- Multiple shelves may not be paralleled together.

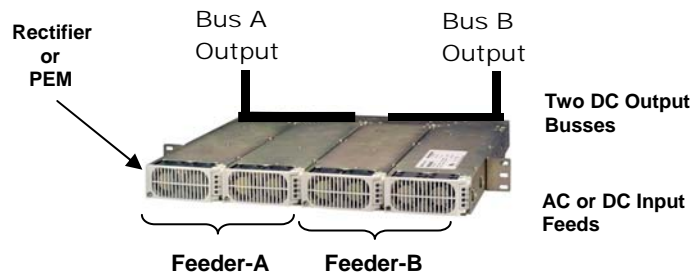

Controllerless Operation

- Lists 4 and 6 ship with a jumper installed on connector J1 pins 21 and 23. This allows the shelf to be powered without a controller. Remove this jumper if controller cable installed.
- CP843A controller ships with a connector that plugs into J1 on a List 1 shelf activating the controller.
- Lists 7, 9 and 14 require cc848836107 connector be installed in J1 to allow the shelf to power up without a controller.

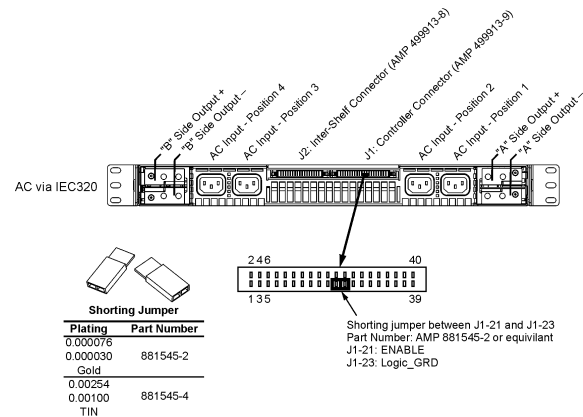

L7, L9, L14 P1 Mating connector (pin out is standard 40 position like L4)

Type	Housing	Mating pin	Crimping tool
Individual wire set	AMP 102387-9 RoHS	20-24 awg: 6-87523-9	91517-1
		22-26 awg: 6-87756-8	91517-1

www.DataSheet4U.com 40 position Ribbon cable AMP 1658621-9 e/w 499252-1 (strain relief) RoHS

This connector set is different because it can accept either a ribbon cable or an individual wire mate.

Communication Signals: J1 Connector

Pin out

Pin	Signal	Pin	Signal
1	POWER_CAP_4	21	Enable side A
2	POWER_CAP_3	22	5VA
3	POWER_CAP_2	23	Logic_GRD
4	POWER_CAP_1	24	Interrupt_1
5	MOD_PRES_4	25	Reset
6	MOD_PRES_3	26	Enable Side B
7	MOD_PRES_2	27	Spacing
8	MOD_PRES_1	28	Spacing
9	PFW_4	29	RS_485_Select
10	PFW_3	30	Shelf_Addr_A
11	PFW_2	31	Shelf_Addr_B
12	PFW_1	32	Shelf_Addr_C
13	SCL_0	33	Shelf_Addr_D
14	SCL_1	34	Shelf_Addr_E
15	SDA_0	35	Shelf_Addr_F
16	SDA_1	36	Shelf_Addr_G
17	OTW	37	Protocol_S
18	Margin	38	RS-485+
19	Fault	39	RS_485-
20	Interrupt_0	40	Ishare

Control Interface Connection (J1 - AMP 499913-9)

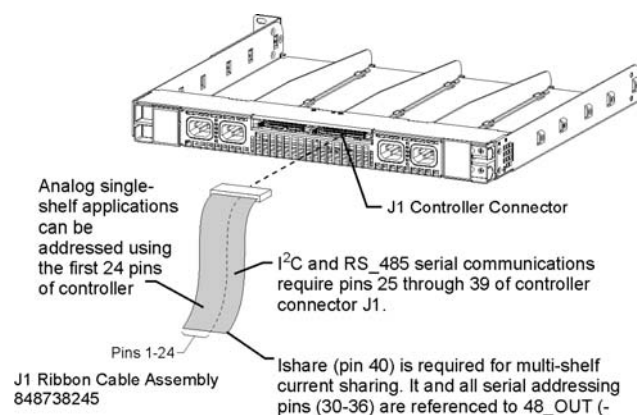

Communication Signals: J2 Connector (cannot be used in split shelves L7, L9, L14)

Pin out

Pin	Signal	Pin	Signal
1	PFW_4	18	Enable Side B
2	PFW_3	19	Spacing
3	PFW_2	20	Spacing
4	PFW_1	21	RS_485_Select
5	SCL_0	22	Shelf_Addr_B
6	SCL_1	23	Shelf_Addr_C
7	SDA_0	24	Shelf_Addr_D
8	SDA_1	25	Shelf_Addr_E
9	OTW	26	Shelf_Addr_F
10	Margin	27	Shelf_Addr_G
11	Fault	28	Shelf_Addr_H
12	Interrupt_0	29	Protocol_S
13	Enable side A	30	RS-485+
14	5VA	31	RS_485-
15	Logic_GRD	32	Ishare
16	Interrupt_1	33	Spare
17	Reset	34	Spare

Multi-shelf Connection (J2 – AMP 499913-8)

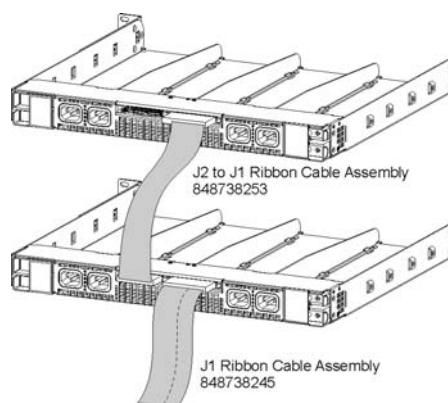

Note: Shelf addressing, current share and RS485 communications are all referenced to the most negative power output Vout(-) of the shelf. For paralleled shelves the Vout(-) terminations must be tied together in order to ensure proper operation of these functions. Modules could get damaged if this connection is not made. .



- CP843A installs in slot 1 of a J85480S1 List 1 shelf. Connections to the controller are made on the left side as shown.
- CP843A controller comes with wire set that plugs into J1 connector to enable the controller.



Specifications

Parameter	Min	Max	Notes
Input			
AC Input Current, per module		15A 30A	IEC-320, C13 type AMP Mate-N-Lok connectors
DC Input Current, per module		60A	
Output			
Programmable output set point	42Vdc	58Vdc	Minimum 44Vdc via hardware marginning
Max Output Current	J85480S1	200A	lugs for 2 ga wires, 2 pairs, 100Amax
Output Terminations			M6 threaded studs on 5/8-inch centers.
Environmental			
Operating Temperature Range	-40°C to 55°C, except J85480 L6, L7, L14 may be used up to 75°C		
Operating Relative Humidity	0 - 95% (non-condensing)		
Storage Temperature Range	-40°C to 85°C		
EMC	FCC, EN 55022, CISPR22, Level A, conducted and radiated		
Immunity	FCC and CISPR22 (EN55022) Class A2		
Safety/Standards Compliance			
Safety Standards	UL1950, EN60950 (IEC950), CSA*234/950		
Certification Marks	Lists 6,7,14: VDE, UL Recognized (Canada and U.S.) Lists 1,4,6,9: VDE, UL Listed (Canada and U.S.)		

Ordering Information

Part Number	Description	Comcode	Usage
Blank Slot Fillers			
	Central Office White	CC848822263	All
	Raven Black	CC848781534	
	Graphite	CC848825233	
Extensions and mounting brackets			
	CP 19 inch mounting bracket kit (includes two brackets and mounting hardware)	CC109145760	L8
	1U high extension bracket kit for 23" cabinets (includes two brackets and mounting hardware)	CC848844803	All
	2U high extension bracket kit for 23" cabinets (includes two brackets and mounting hardware)	848683009	All
Cables / Connectors for J85480S1 Shelves			
	Ribbon cable for attaching a controller to the power shelf – 10 ft. One end mates into J1 the other end not terminated.	848738245	L1, L4, L6
	Inter-shelf connector for daisy-chaining shelves – 9 in between J1 of 2 nd and J2 of 1 st shelf	848738253	L1, L4, L6
	2 AWG DC output cable set – 10 ft (1 RED and 1 BLACK cable)	848748987	All
	AC Input cable: High temperature IEC 320 C13 straight over-mold (one end), NEMA5-15P plug (one end), 14 AWG, 10 ft	CC848776105	L4, L5
	AC input cable: IEC 320 C13 plug (one end), other end not terminated , 14 AWG, 14 ft,	847861192	L1, L4, L9
	AC input cable: AMP 3-pin Mate-N-Lok, 14 AWG, 3 ft, other end not terminated	CC848763301	L6, L7, L8, L9
	AC input cable: AMP 3-pin Mate-N-Lok, 14 AWG, 10 ft, other end not terminated	CC848793026	L6, L7, L8, L9
	Inter-shelf cable for RS-485 specific shelf.	CC848786153	L8
	Office alarm cable for RS-485 specific shelf	CC848786161	L8
	DC input cable – 4 ft	CC848794908	L14
	Shorting jumper for J1 connector ENABLE for single output shelf (see locating picture)	AMP 881545-2	L4, L6,
	P1 connector ENABLE jumper for split shelf	CC848836107	L7, L9, L14
Pulsar Controllers for J85480S1 Shelves			Picture
NE843G	1U standalone Controller (Display, DB9 craft port and RJ45 ethernet)	CC109139358	
CP843A	CP Shelf Mounted Controller (Display and RJ45 ethernet)	CC109129895	
Cables for Pulsar Controllers			
	NE843G to CP Shelf Cable Kit (Includes 2ft power and communication cable)	CC109144820	
	J4 Output Alarm Cable 50ft – 24ga solid twisted pair	CC848817635	
	J4 Output Alarm Cable 150ft – 24ga solid twisted pair	CC848817643	
	J3 Input Alarm Cable 50ft – 24ga Stranded	CC848817651	
	J3 Input Alarm Cable 150ft – 24ga Stranded	CC848817668	

Safety

Safety Symbols and Guidelines

Read and understand all instructions before attempting any installation of this product. When installing, operating, or maintaining the J85480S1 Power System, basic safety precautions should always be followed to reduce the risk of fire, electric shock, and injury to persons. Such precautions include the following:



This symbol identifies the need to refer to the equipment instructions for important information.



This symbol identifies the presence of hazardous AC or DC voltages or hazardous energy levels. In the context of this product

- The DC output cables contain electrical energy levels capable of causing heating and arcing if shorted to metal objects. Make connections with the power disconnected.
- Hazardous AC voltage and DC electrical energy is contained within the enclosure of the power shelf. No user or field serviceable parts inside.



This symbol is used to identify safety earth ground connection points within the equipment.

Product Labeling

Follow all warnings and instructions marked on the product. Some of the safety symbols used with the CP1800 Rectifier and J85480S1 Shelf may include the following. They may also be accompanied by instructions:

Mounting and Installation

- This product shall be installed in compliance with mounting requirements for the ultimate application.
- This product must be installed, serviced, and operated only by skilled and qualified personnel who have the necessary knowledge and practical experience with electrical equipment and who understand the hazards that can arise when working on this type of equipment. This product is intended for use in a Restricted Access Location.
- This equipment is to be used in controlled environments (an area where the humidity is maintained at levels that cannot cause condensation on the equipment, the contaminating dust is controlled, and the steady-state ambient temperature is within the range specified).
- This equipment has been evaluated for use in a continuous ambient temperature of up to 55°C and the application environment should not exceed 55°C.
- The CE mark if provided on the product is applied to show conformance to the requirements outlined in the European Union's Low Voltage Directive {72/73/EEC} and EMC Directive {89/336/EEC}, as amended by the CE Mark Directive {93/ 68/EEC}.
- The J85480S1 shelf, when used with the CP1800 rectifiers, has been evaluated for hot swapping.
- A separate protective Earthing terminal is provided at the reach of the shelf
 - the building installation shall provide a means for connection to protective earth; and
 - the equipment is to be connected to that means; and
 - a SERVICE PERSON shall check whether or not the socket-outlet from which the equipment is to be powered provides a connection to the building protective earth. If not, the SERVICE PERSON shall arrange for the installation of a PROTECTIVE EARTHING CONDUCTOR from the separate protective Earthing terminal to the protective earth wire in the building.

www.DataSheet4U.com

Output Connections

- All field wiring should comply with the U.S. National Electrical Code (NEC) and/or applicable local codes/standards.
- Routing of the DC output cables should guarantee that cables are not in contact with sources of heat and surfaces that may damage the cable insulation.
- The DC output is not provided with a fuse or circuit breaker suitable for branch circuit protection. Therefore, the power shelf should be mounted in the same rack or cabinet as the equipment being powered. Use interconnecting power cables suitable for the application and sized to carry the rated output current. The interconnecting cables should be capable of carrying the overload current and short circuit current without damage or risk of fire.
- The output for the system is SELV and has available power greater than 240VA.
- Insulation on output field-wired conductors should be rated no less than 90°C. Wiring internal to enclosed equipment cabinets should be rated at 105°C (minimum). The provided DC output cords (red and black wires) are rated for 105°C.
- Before opening the insulating cover to gain access to load and ground connections, ensure all power supplies are disconnected from the AC MAINS.

AC Input Connections

- AC branch circuits to this equipment must be protected with fuses or circuit breakers sized as required by the U.S. National Electric Code (NEC) and/or local codes. Up to four AC mains power cords are required to power the shelf (one for each rectifier). Each power cord should be connected to a separate AC mains branch circuit with an overcurrent protector rated at no more than 20A.
- The power supply mains inlet may be used as the means to provide AC protective earthing.
- An accessible AC disconnect/protection device to remove AC power from the equipment in the event of an emergency must be provided. An accessible socket-outlet/receptacle installed near the equipment is also acceptable as a disconnect.
- The equipment is powered by multiple AC inputs (one per rectifier). Disconnect all AC sources of power before servicing.
- These units are to be used with TN-S power systems only.

German Safety Guidelines

Installationsanleitung

- Alle Ausgänge des Gerätes erfüllen die Anforderungen für SELV nach IEC/EN60950-1.
- Die Ausgänge des Gerätes liegen über den Limits für Energiegefahr nach IEC/EN60950-1 (>240 VA). Das Gerät ist zum Einbau in ein Montage-Rack bestimmt. Siehe Einbaubestimmungen in der Montageanleitung, um eine Gefährdung des Benutzers während der Installation zu vermeiden.

ACHTUNG:

Hoher Ableitstrom Vor Anschluss an den Versorgungsstromkreis unbedingt Erdungsverbinding herstellen

- Das Produkt ist zum Gebrauch in einer Umgebungstemperatur von max. 55°C bestimmt.
- Die Gerätestecker des Produktes sind dazu bestimmt, eine sichere Erdung des Gerätes herzustellen.
- Das Produkt ist zum Gebrauch in einer Umgebung mit Verschmutzungsgrad 2 nach IEC/EN60950 bestimmt.
- Die Netzteile des Gerätes können während des Betriebes einzeln ausgetauscht werden (Hot Swapping).
- Das Gerät wurde zusammen mit den Anschlussleitungen (ohne Anschlussstecker) geprüft. Die Installation eines Steckers des jeweiligen Landes, sollte nur durch geschultes Service Personal durchgeführt werden. Als alternative könnte eine Vorinstallation des Steckers bereits bei der Herstellung erfolgt sein.



World Wide Headquarters

Lineage Power
3000 Skyline Drive, Mesquite, TX 75149, USA
+1-800-843-1797
power.lineagepower.com

Europe, Middle-East and Africa Headquarters

Lineage Power (UK)
Tel: +44 (0) 1344 469 300, Fax: +44 (0) 1344 469 301

Caribbean-Latin America-Brazil Headquarters

Lineage Power
Tel: +56 2 209 8211, Fax: +56 2 223 1477

Asia-Pacific Headquarters

Lineage Power Singapore
Tel: +65 6416 4283, Fax: +66 6416 4299

India

Lineage Power India
Tel: +91 80 841 1633 x3001

Lineage Power reserves the right to make changes to the product(s) or information contained herein without notice. No liability is assumed as a result of their use or application. No rights under any patent accompany the sale of any such product(s) or information.

©2010 Lineage Power (Mesquite, Texas) All International Rights Reserved.

www.DataSheet4U.com

GGs – March 2010