

12CLQ150 (JANS1N7039CCU1)

PD-20532H

Schottky Rectifier High Efficiency Series Surface Mount (SMD-1) 150V, 35A

Features

- Hermetically sealed
- Center Tap
- Low forward voltage drops
- High frequency operation
- Guard ring for enhanced ruggedness and long term reliability
- Surface Mount
- Light weight
- ESD Rating: Class 1B per MIL-STD-750, Method 1020

Potential Applications

- DC-DC converter
- Protection circuits
- Motor drives

Product Validation

Fully qualified according to MIL-PRF-19500 for space applications

Description

The 12CLQ150 (1N7039CCU1) center tap Schottky rectifier has been expressly designed to meet the rigorous requirements of IR HiRel environments. It is packaged in the hermetic surface mount SMD-1 ceramic package. The device's forward voltage drop and reverse leakage current are optimized for the lowest power loss and the highest circuit efficiency for typical high frequency switching power supplies and resonant power converters. Full MIL-PRF-19500 quality conformance testing is available on source control drawings to TX, TXV and S quality levels.

Ordering Information

Table 1 Ordering options

Part number	Package	Screening Level
12CLQ150	SMD-1	COTS
12CLQ150SCS	SMD-1	S-Level
12CLQ150SCX	SMD-1	TX-Level
12CLQ150SCV	SMD-1	TXV-Level
JANS1N7039CCU1	SMD-1	JANS
JANTX1N7039CCU1	SMD-1	JANTX
JANTXV1N7039CCU1	SMD-1	JANTXV

Product Summary

- **V_{RRM}**: 150V
- **I_{F(AV)}**: 35A
- **V_F @ 15Apk, T_J = 125°C**: 0.86V
- **I_{FSM} @ t_p = 8.3ms half-sine**: 200A
- **REF**: MIL-PRF-19500/737

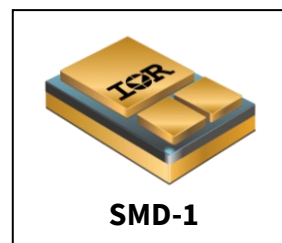

Table of contents

Table of contents

Features	1
Potential Applications.....	1
Product Validation.....	1
Description	1
Ordering Information.....	1
Table of contents.....	2
1 Absolute Maximum Ratings	3
2 Device Characteristics	4
2.1 Electrical Characteristics	4
2.2 Thermal-Mechanical Specifications	4
3 Electrical Characteristics Curves.....	5
4 Package Outline.....	7
Revision history.....	8

Absolute Maximum Ratings**1 Absolute Maximum Ratings****Table 2 Absolute Maximum Ratings**

Symbol	Parameter	Value	Unit
V_R	Max. DC reverse voltage (Per Leg)	150	V
V_{RWM}	Max. Working peak reverse voltage (Per Leg)	150	V
$I_{F(AV)}$	Max. average forward current - Refer to Fig. 5 ¹	35	A
I_{FSM}	Max. peak one cycle non-repetitive surge current ²	200	A
T_J T_{STG}	Operating Junction and Storage Temperature Range	-65 to 150	°C
	Weight	2.6 (Typical)	g

¹ 50% duty cycle @ $T_c = 95^\circ\text{C}$, square waveform² $t_p = 8.3$ ms half-sine

Device Characteristics

2 Device Characteristics

2.1 Electrical Characteristics

Table 3 Electrical Characteristics

Symbol	Parameter	Max.	Unit	Test Conditions	
V_F	Forward Voltage Drop (Per Leg) See Fig. 1 ¹	1.35	V	@ 15A	$T_J = -55^\circ\text{C}$
		1.13	V	@ 15A	$T_J = 25^\circ\text{C}$
		1.60	V	@ 35A	
		0.86	V	@ 15A	$T_J = 125^\circ\text{C}$
		1.20	V	@ 35A	
I_R	Reverse Leakage Current (Per Leg) See Fig. 2 ¹	0.5	mA	$T_J = 25^\circ\text{C}$	$V_R = \text{rated } V_R$
		15	mA	$T_J = 125^\circ\text{C}$	
C_J	Junction Capacitance (Per Leg)	405	pF	$V_R = 5V_{DC}$ (1MHz, 25°C)	
L_S	Series Inductance (Per Leg)	5.9 (Typical)	nH	Measured from center of cathode pad to center of anode pad	

2.2 Thermal-Mechanical Specifications

Table 4 Thermal-Mechanical Specifications

Symbol	Parameter	Max.	Unit	Test Conditions
$R_{\theta JC}$	Max. Thermal Resistance, Junction to Case (Per Leg)	1.67	$^\circ\text{C}/\text{W}$	DC operation See Fig. 4
$R_{\theta JC}$	Max. Thermal Resistance, Junction to Case (Per Package)	0.83	$^\circ\text{C}/\text{W}$	DC operation
	Die Size (Typical)	125 x 125	mils	

¹ Pulse Width < 300 μs , Duty Cycle < 2%

Electrical Characteristics Curves

3 Electrical Characteristics Curves

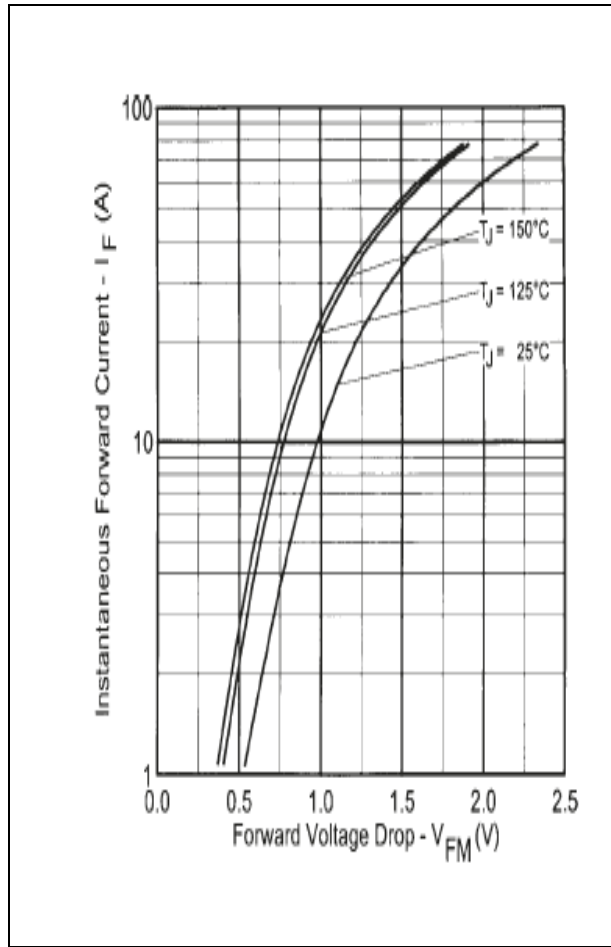

Figure 1 Maximum Forward Voltage Drop Characteristics (Per Leg)

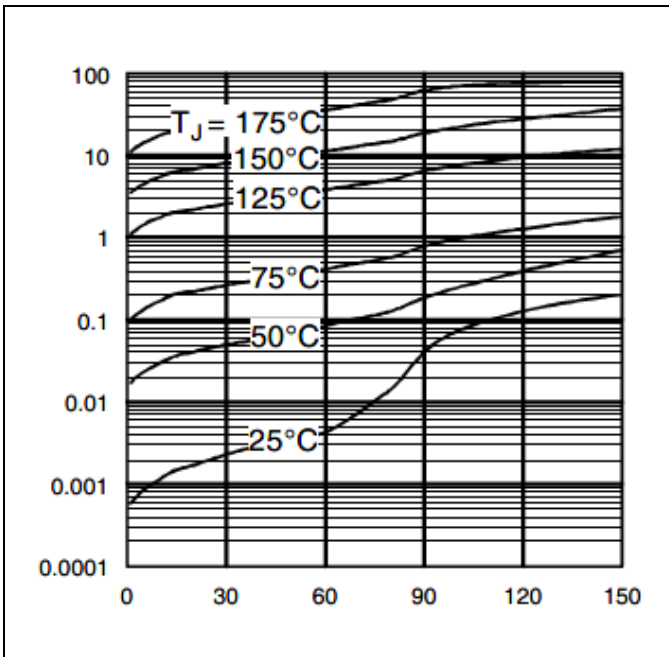

Figure 2 Typical Values of Reverse Current Vs. Reverse Voltage (Per Leg)

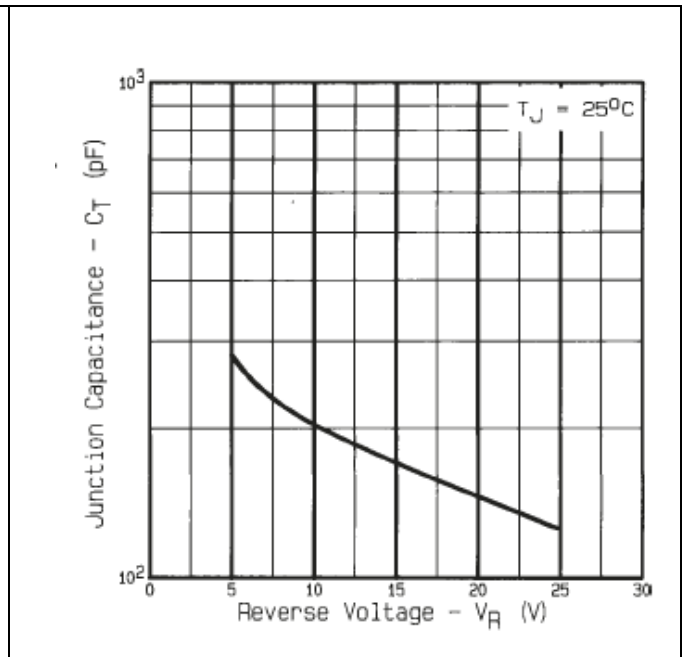

Figure 3 Typical Junction Capacitance Vs. Reverse Voltage (Per Leg)

12CLQ150 (JANS1N7039CCU1)

Schottky Rectifier High Efficiency Series Surface Mount (SMD-1)

Electrical Characteristics Curves

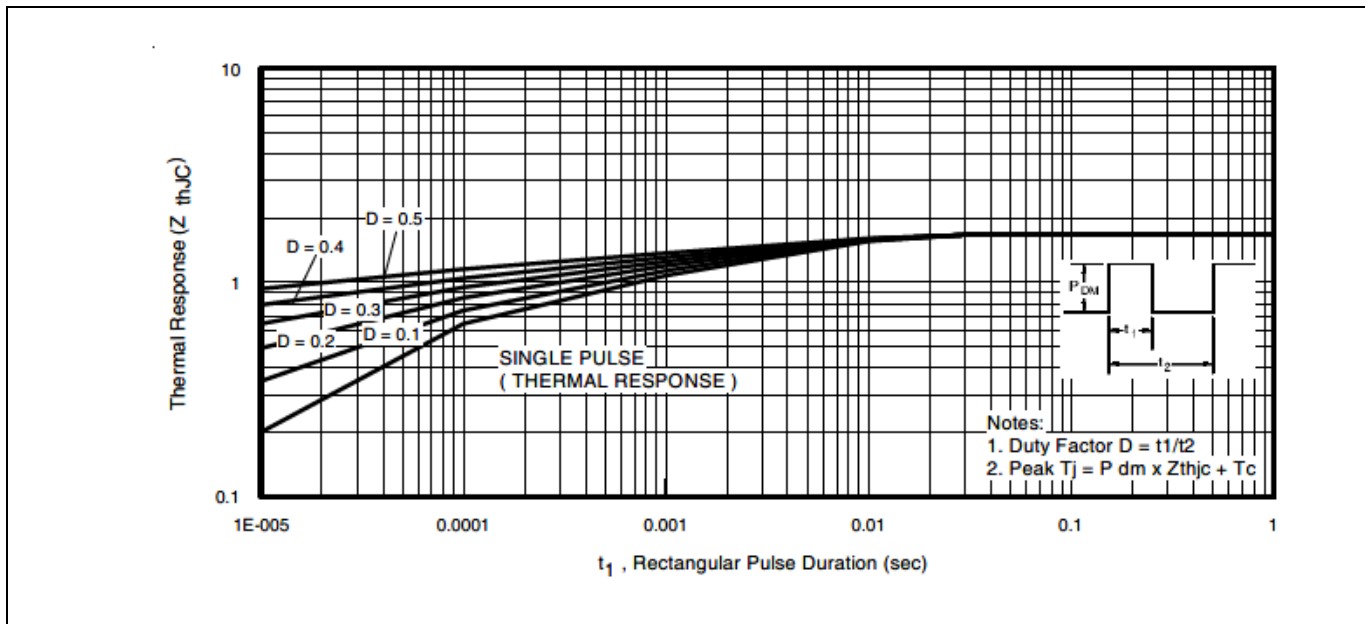

Figure 4 Maximum Thermal Impedance Z_{thJC} Characteristics (Per Leg)

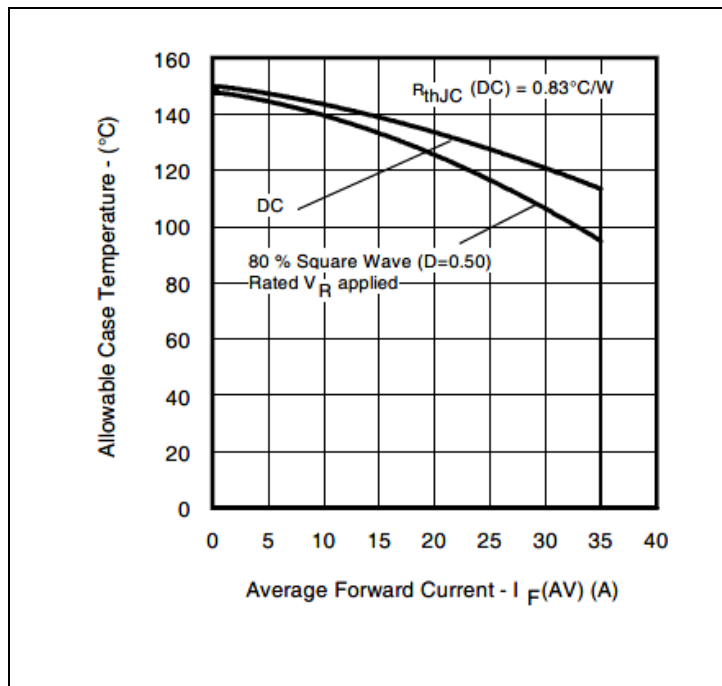

Figure 5 Maximum Allowable Case Temperature Vs. Average Forward Current (Per Leg)

12CLQ150 (JANS1N7039CCU1)

Schottky Rectifier High Efficiency Series Surface Mount (SMD-1)

Package Outline

4 Package Outline

Note: For the most updated package outline, please see the website: [SMD-1](#)

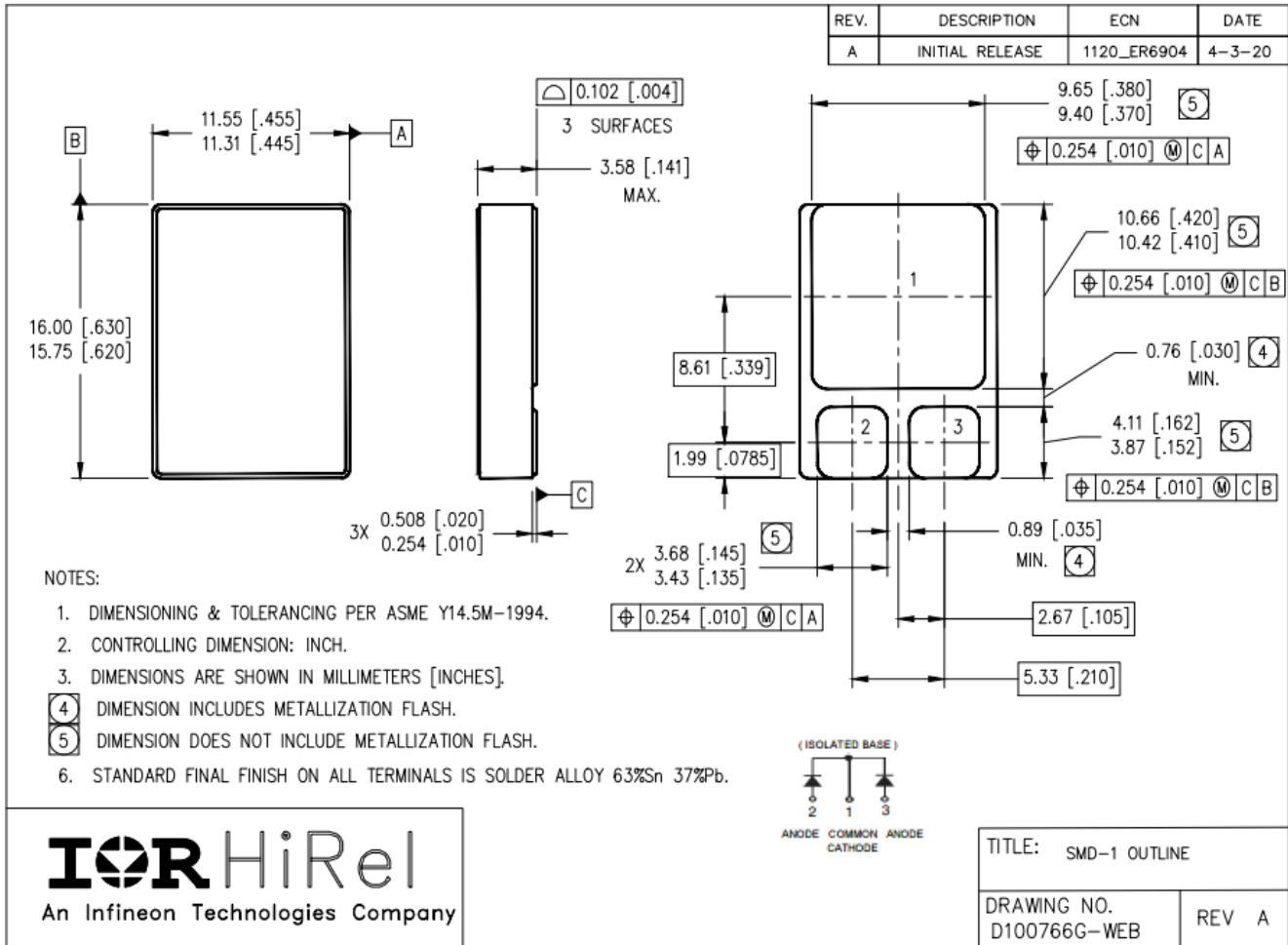

12CLQ150 (JANS1N7039CCU1)

Schottky Rectifier High Efficiency Series Surface Mount (SMD-1)

Revision history

Revision history

Document version	Date of release	Description of changes
	09/15/1997	Final datasheet (PD-20532)
Rev A	03/05/1999	Updated VFM
Rev B	03/01/2000	Updated Case style
Rev C	02/25/2002	Updated new format
Rev D	09/17/2002	Updated schematic
Rev E	10/07/2002	Updated Zth curve
Rev F	06/13/2008	Updated per ECN-16064
Rev G	10/03/2012	Added ESD
Rev H	06/20/2024	Updated per ECN-1120_09965

Trademarks

All referenced product or service names and trademarks are the property of their respective owners.

Edition 2024-06-20

Published by

**International Rectifier HiRel Products,
Inc.**

**An Infineon Technologies company
El Segundo, California 90245 USA**

**© 2024 Infineon Technologies AG.
All Rights Reserved.**

**Do you have a question about this
document?**

Email: erratum@infineon.com

Document reference

IMPORTANT NOTICE

The information given in this document shall in no event be regarded as a guarantee of conditions or characteristics ("Beschaffheitsgarantie").

With respect to any examples, hints or any typical values stated herein and/or any information regarding the application of the product, Infineon Technologies hereby disclaims any and all warranties and liabilities of any kind, including without limitation warranties of non-infringement of intellectual property rights of any third party.

In addition, any information given in this document is subject to customer's compliance with its obligations stated in this document and any applicable legal requirements, norms and standards concerning customer's products and any use of the product of Infineon Technologies in customer's applications.

The data contained in this document is exclusively intended for technically trained staff. It is the responsibility of customer's technical departments to evaluate the suitability of the product for the intended application and the completeness of the product information given in this document with respect to such application.

For further information on the product, technology, delivery terms and conditions and prices please contact your nearest Infineon Technologies office (www.infineon.com).

WARNINGS

Due to technical requirements components may contain dangerous substances. For information on the types in question please contact your nearest International Rectifier HiRel Products, Inc., an Infineon Technologies company, office.

International Rectifier HiRel Components may only be used in life-support devices or systems with the expressed written approval of International Rectifier HiRel Products, Inc., an Infineon Technologies company, if failure of such components can reasonably be expected to cause the failure of that life-support device or system, or to affect the safety and effectiveness of that device or system.

Life support devices or systems are intended to be implanted in the human body, or to support and/or maintain and sustain and/or protect human life. If they fail, it is reasonable to assume that the health of the user or other persons may be endangered.