

**RADIATION HARDENED  
 POWER MOSFET  
 THRU-HOLE (TO-39)**

**IRHF9230  
 JANSR2N7390  
 200V, P-CHANNEL  
 REF: MIL-PRF-19500/630  
 RAD-Hard™ HEXFET® TECHNOLOGY**

**Product Summary**

Part Number	Radiation Level	R <sub>DS(on)</sub>	I <sub>D</sub>	QPL Part Number
IRHF9230	100K Rads (Si)	0.80Ω	-4.0A	JANSR2N7390
IRHF93230	300K Rads (Si)	0.80Ω	-4.0A	JANSF2N7390

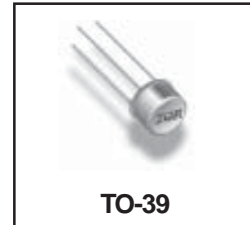

International Rectifier's RAD-Hard HEXFET™ technology provides high performance power MOSFETs for space applications. This technology has over a decade of proven performance and reliability in satellite applications. These devices have been characterized for both Total Dose and Single Event Effects (SEE). The combination of low R<sub>ds(on)</sub> and low gate charge reduces the power losses in switching applications such as DC to DC converters and motor control. These devices retain all of the well established advantages of MOSFETs such as voltage control, fast switching, ease of paralleling and temperature stability of electrical parameters.

**Features:**

- Single Event Effect (SEE) Hardened
- Low R<sub>DS(on)</sub>
- Low Total Gate Charge
- Proton Tolerant
- Simple Drive Requirements
- Ease of Paralleling
- Hermetically Sealed
- Ceramic Package
- Light Weight

**Absolute Maximum Ratings**

**Pre-Irradiation**

	Parameter		Units
I <sub>D</sub> @ V <sub>GS</sub> = -12V, T <sub>C</sub> = 25°C	Continuous Drain Current	-4.0	A
I <sub>D</sub> @ V <sub>GS</sub> = -12V, T <sub>C</sub> = 100°C	Continuous Drain Current	-2.4	
I <sub>DM</sub>	Pulsed Drain Current ①	-16	
P <sub>D</sub> @ T <sub>C</sub> = 25°C	Max. Power Dissipation	25	W
	Linear Derating Factor	0.2	W/°C
V <sub>GS</sub>	Gate-to-Source Voltage	±20	V
E <sub>AS</sub>	Single Pulse Avalanche Energy ②	171	mJ
I <sub>AR</sub>	Avalanche Current ①	-4.0	A
E <sub>AR</sub>	Repetitive Avalanche Energy ①	2.5	mJ
dv/dt	Peak Diode Recovery dv/dt ③	-27	V/ns
T <sub>J</sub>	Operating Junction	-55 to 150	°C
T <sub>STG</sub>	Storage Temperature Range		
	Lead Temperature	300 ( 0.063 in. (1.6mm) from case for 10s)	
	Weight	0.98 (typical)	g

For footnotes refer to the last page

**Electrical Characteristics @ T<sub>j</sub> = 25°C (Unless Otherwise Specified)**

	Parameter	Min	Typ	Max	Units	Test Conditions
BV <sub>DSS</sub>	Drain-to-Source Breakdown Voltage	-200	—	—	V	V <sub>GS</sub> = 0V, I <sub>D</sub> = -1.0mA
ΔBV <sub>DSS</sub> /ΔT <sub>J</sub>	Temperature Coefficient of Breakdown Voltage	—	-0.25	—	V/°C	Reference to 25°C, I <sub>D</sub> = -1.0mA
R <sub>DS(on)</sub>	Static Drain-to-Source On-State Resistance	—	—	0.80	Ω	V <sub>GS</sub> = -12V, I <sub>D</sub> = -2.4A <sup>④</sup>
		—	—	0.92		V <sub>GS</sub> = -12V, I <sub>D</sub> = -4.0A <sup>④</sup>
V <sub>GS(th)</sub>	Gate Threshold Voltage	-2.0	—	-4.0	V	V <sub>DS</sub> = V <sub>GS</sub> , I <sub>D</sub> = -1.0mA
g <sub>fs</sub>	Forward Transconductance	2.5	—	—	S (r)	V <sub>DS</sub> > -15V, I <sub>DS</sub> = -4.0A <sup>④</sup>
I <sub>DSS</sub>	Zero Gate Voltage Drain Current	—	—	-25	μA	V <sub>DS</sub> = -160V, V <sub>GS</sub> = 0V
		—	—	-250		V <sub>DS</sub> = -160V, V <sub>GS</sub> = 0V, T <sub>J</sub> = 125°C
I <sub>GSS</sub>	Gate-to-Source Leakage Forward	—	—	-100	nA	V <sub>GS</sub> = -20V
I <sub>GSS</sub>	Gate-to-Source Leakage Reverse	—	—	100		V <sub>GS</sub> = 20V
Q <sub>g</sub>	Total Gate Charge	—	—	45	nC	V <sub>GS</sub> = -12V, I <sub>D</sub> = -4.0A V <sub>DS</sub> = -100V
Q <sub>gs</sub>	Gate-to-Source Charge	—	—	10		
Q <sub>gd</sub>	Gate-to-Drain ('Miller') Charge	—	—	25		
t <sub>d(on)</sub>	Turn-On Delay Time	—	—	30	ns	V <sub>DD</sub> = -100V, I <sub>D</sub> = -4.0A, V <sub>GS</sub> = -12V, R <sub>G</sub> = 7.5Ω
t <sub>r</sub>	Rise Time	—	—	30		
t <sub>d(off)</sub>	Turn-Off Delay Time	—	—	75		
t <sub>f</sub>	Fall Time	—	—	65		
L <sub>S</sub> + L <sub>D</sub>	Total Inductance	—	7.0	—	nH	Measured from drain lead (6mm/0.25in. from package) to source lead (6mm/0.25in. from package)
C <sub>iss</sub>	Input Capacitance	—	1200	—	pF	V <sub>GS</sub> = 0V, V <sub>DS</sub> = -25V f = 1.0MHz
C <sub>oss</sub>	Output Capacitance	—	190	—		
C <sub>rss</sub>	Reverse Transfer Capacitance	—	45	—		

**Source-Drain Diode Ratings and Characteristics**

	Parameter	Min	Typ	Max	Units	Test Conditions
I <sub>S</sub>	Continuous Source Current (Body Diode)	—	—	-4.0	A	
I <sub>SM</sub>	Pulse Source Current (Body Diode) <sup>①</sup>	—	—	-16		
V <sub>SD</sub>	Diode Forward Voltage	—	—	-5.0	V	T <sub>j</sub> = 25°C, I <sub>S</sub> = -4.0A, V <sub>GS</sub> = 0V <sup>④</sup>
t <sub>rr</sub>	Reverse Recovery Time	—	—	400	nS	T <sub>j</sub> = 25°C, I <sub>F</sub> = -4.0A, di/dt ≤ -100A/μs
Q <sub>RR</sub>	Reverse Recovery Charge	—	—	1.6	μC	V <sub>DD</sub> ≤ -100V <sup>④</sup>
t <sub>on</sub>	Forward Turn-On Time	Intrinsic turn-on time is negligible. Turn-on speed is substantially controlled by L <sub>S</sub> + L <sub>D</sub> .				

**Thermal Resistance**

	Parameter	Min	Typ	Max	Units	Test Conditions
R <sub>thJC</sub>	Junction-to-Case	—	—	5.0	°C/W	Typical socket mount
R <sub>thJA</sub>	Junction-to-Ambient	—	—	175		

Note: Corresponding Spice and Saber models are available on the G&S Website.

For footnotes refer to the last page

## Radiation Characteristics

IRHF9230

International Rectifier Radiation Hardened MOSFETs are tested to verify their radiation hardness capability. The hardness assurance program at International Rectifier is comprised of two radiation environments. Every manufacturing lot is tested for total ionizing dose (per notes 5 and 6) using the TO-3 package. Both pre- and post-irradiation performance are tested and specified using the same drive circuitry and test conditions in order to provide a direct comparison.

**Table 1. Electrical Characteristics @ Tj = 25°C, Post Total Dose Irradiation ⑤⑥**

	Parameter	100K Rads(Si) <sup>1</sup>		300K Rads (Si) <sup>2</sup>		Units	Test Conditions
		Min	Max	Min	Max		
BV <sub>DSS</sub>	Drain-to-Source Breakdown Voltage	-200	—	-200	—	V	V <sub>GS</sub> = 0V, I <sub>D</sub> = -1.0mA
V <sub>GS(th)</sub>	Gate Threshold Voltage	-2.0	-4.0	-2.0	-5.0		V <sub>GS</sub> = V <sub>DS</sub> , I <sub>D</sub> = -1.0mA
I <sub>GSS</sub>	Gate-to-Source Leakage Forward	—	-100	—	-100	nA	V <sub>GS</sub> = -20V
I <sub>GSS</sub>	Gate-to-Source Leakage Reverse	—	100	—	100		V <sub>GS</sub> = 20 V
I <sub>DSS</sub>	Zero Gate Voltage Drain Current	—	-25	—	-25	μA	V <sub>DS</sub> = -160V, V <sub>GS</sub> = 0V
R <sub>DS(on)</sub>	Static Drain-to-Source ④ On-State Resistance (TO-3)	—	0.8	—	0.8	Ω	V <sub>GS</sub> = -12V, I <sub>D</sub> = -2.4A
R <sub>DS(on)</sub>	Static Drain-to-Source ④ On-State Resistance (TO-39)	—	0.8	—	0.8	Ω	V <sub>GS</sub> = -12V, I <sub>D</sub> = -2.4A
V <sub>SD</sub>	Diode Forward Voltage ④	—	-5.0	—	-5.0	V	V <sub>GS</sub> = 0V, I <sub>S</sub> = -4.0A

1. Part number IRHF9230 (JANSR2N7390)

2. Part number IRHF93230 (JANSF2N7390)

International Rectifier radiation hardened MOSFETs have been characterized in heavy ion environment for Single Event Effects (SEE). Single Event Effects characterization is illustrated in Fig. a and Table 2.

**Table 2. Single Event Effect Safe Operating Area**

Ion	LET MeV/(mg/cm <sup>2</sup> )	Energy (MeV)	Range (μm)	V <sub>DS</sub> (V)				
				@V <sub>GS</sub> =0V	@V <sub>GS</sub> =5V	@V <sub>GS</sub> =10V	@V <sub>GS</sub> =15V	@V <sub>GS</sub> =20V
Cu	28.0	285	43.0	-200	-200	-200	-200	—
Br	36.8	305	39.0	-200	-200	-125	-75	—

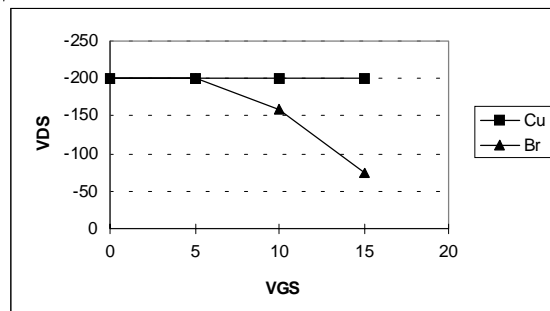

**Fig a. Single Event Effect, Safe Operating Area**

For footnotes refer to the last page

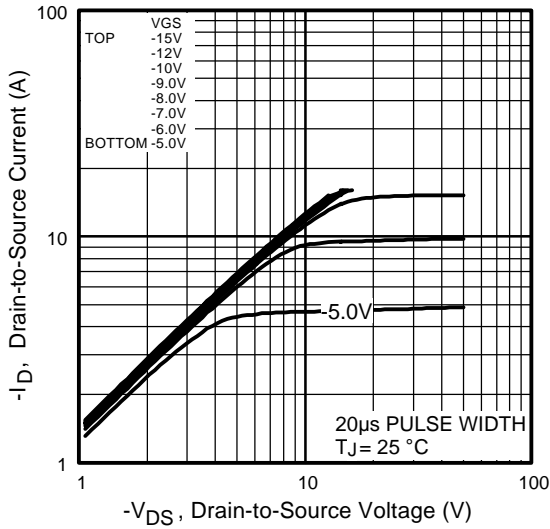

Fig1. Typical Output Characteristics

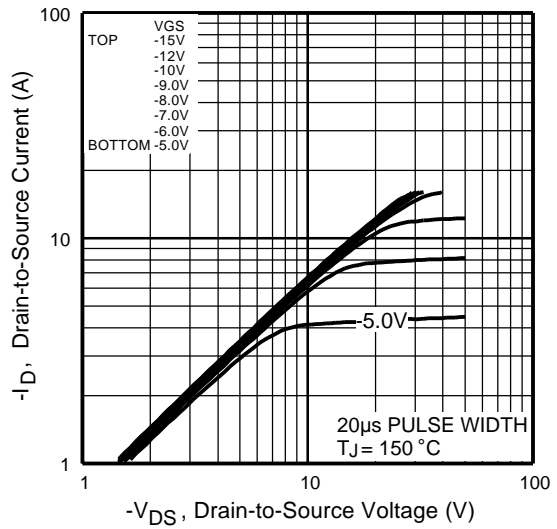

Fig2. Typical Output Characteristics

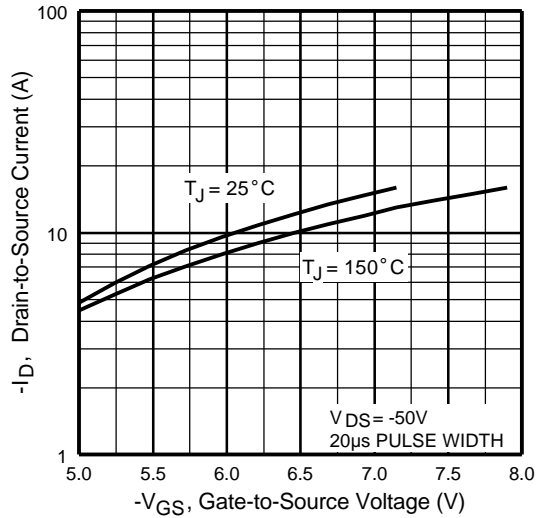

Fig3. Typical Transfer Characteristics

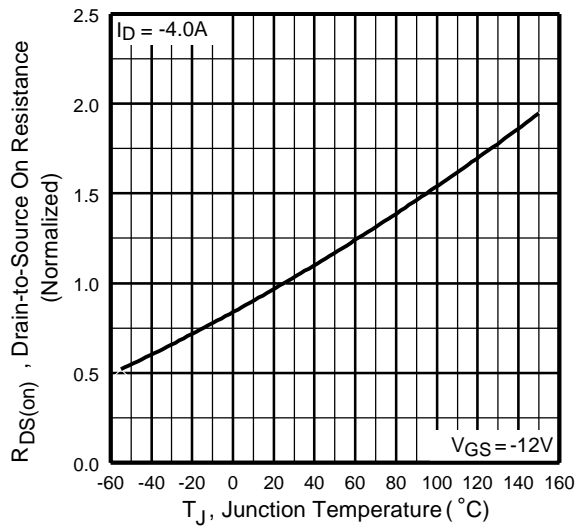
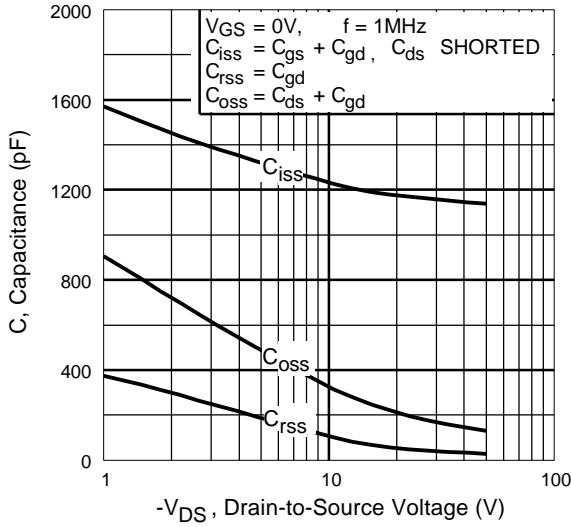
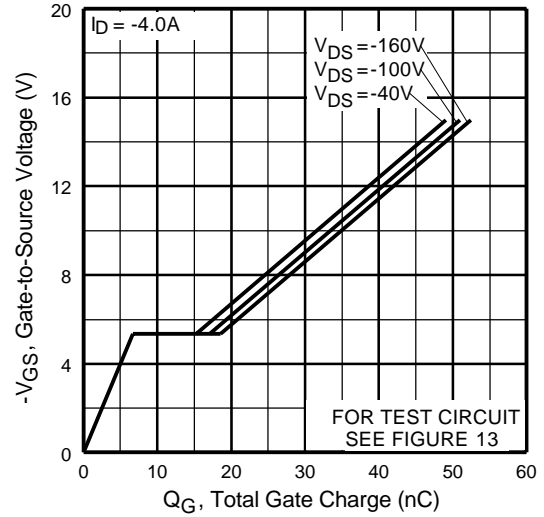

Fig4. Normalized On-Resistance Vs. Temperature



**Fig5.** Typical Capacitance Vs. Drain-to-Source Voltage



**Fig6.** Typical Gate Charge Vs. Gate-to-Source Voltage

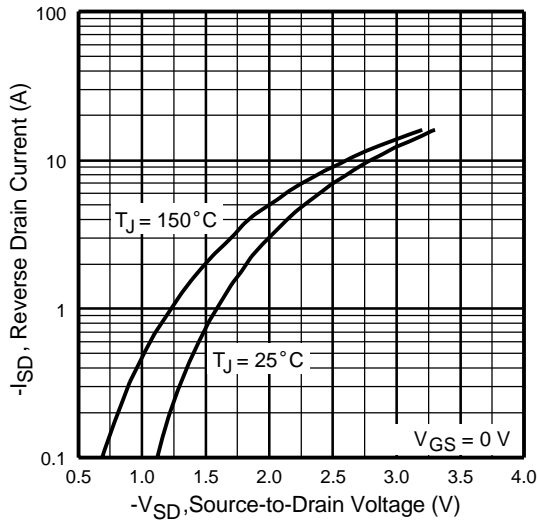

**Fig7.** Typical Source-Drain Diode Forward Voltage

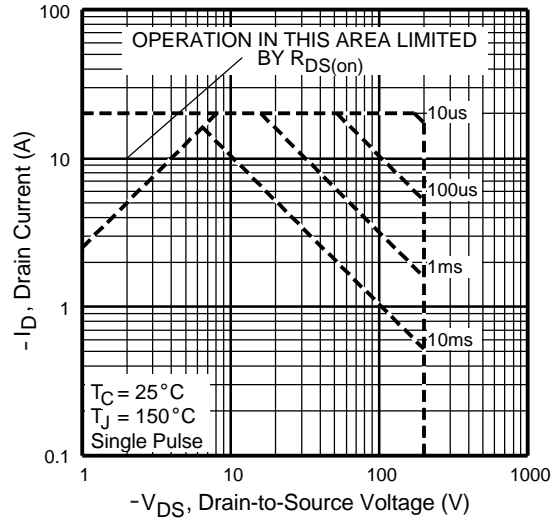

**Fig8.** Maximum Safe Operating Area

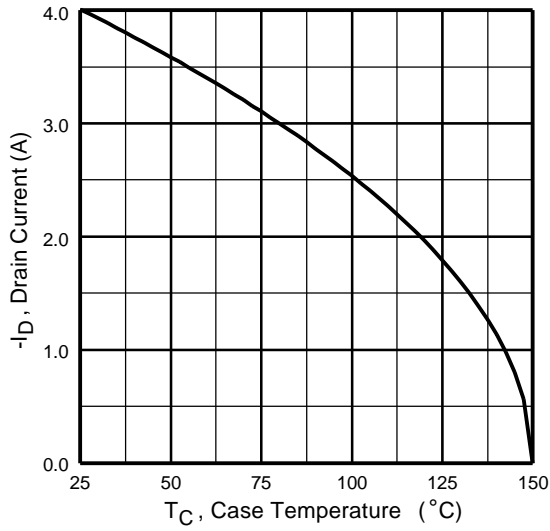

**Fig9.** Maximum Drain Current Vs. Case Temperature

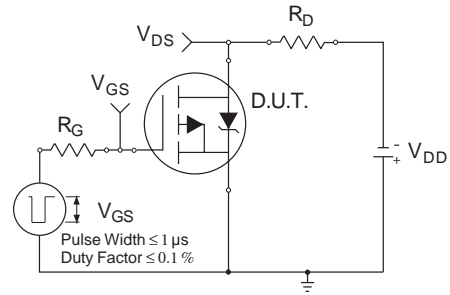

**Fig10a.** Switching Time Test Circuit

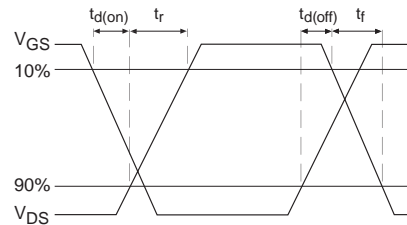

**Fig10b.** Switching Time Waveforms

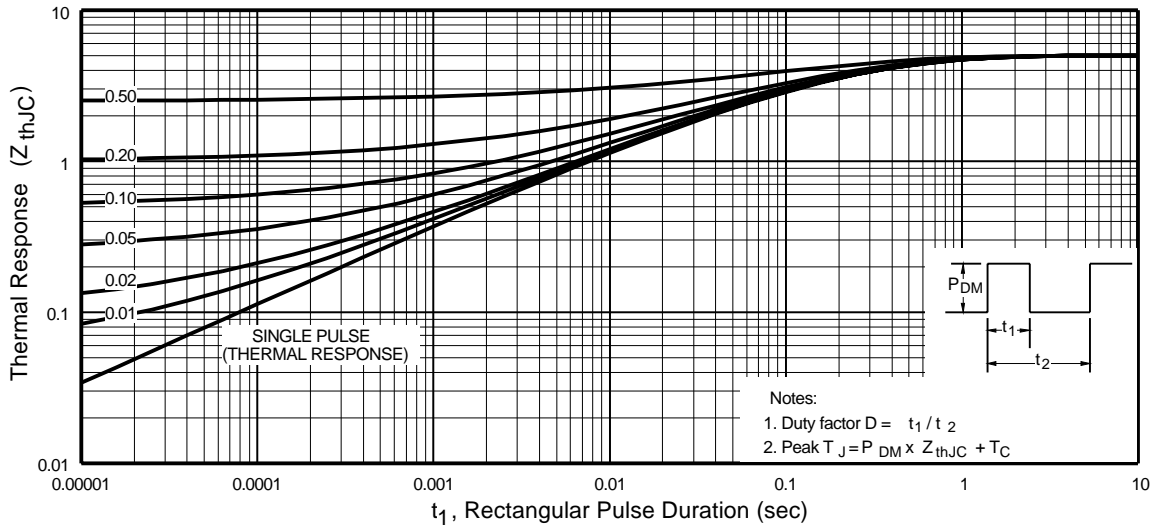

**Fig11.** Maximum Effective Transient Thermal Impedance, Junction-to-Case

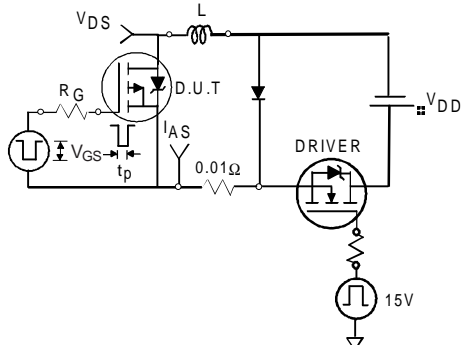

Fig12a. Unclamped Inductive Test Circuit

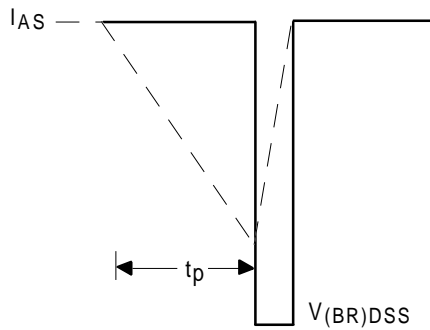

Fig12b. Unclamped Inductive Waveforms

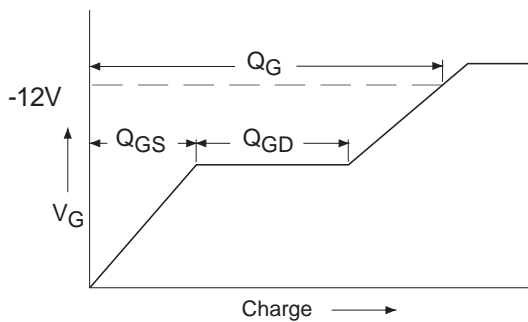

Fig13a. Basic Gate Charge Waveform

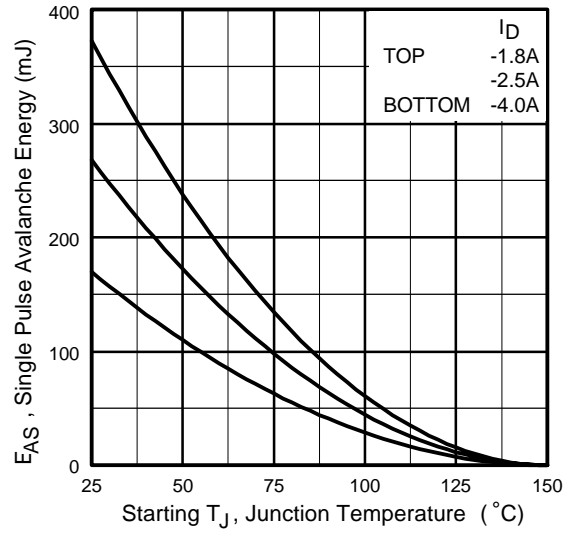

Fig12c. Maximum Avalanche Energy Vs. Drain Current

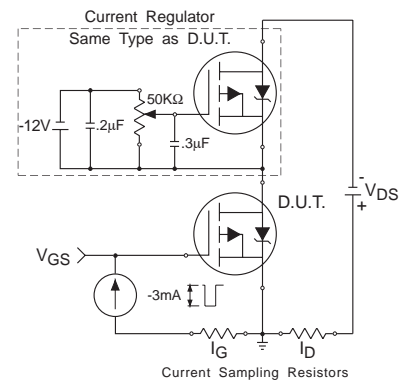

Fig13b. Gate Charge Test Circuit

# IRHF9230

# Pre-Irradiation

## Foot Notes:

- ① Repetitive Rating; Pulse width limited by maximum junction temperature.
- ② VDD = -50V, starting T<sub>J</sub> = 25°C, L=21.4mH  
Peak I<sub>L</sub> = -4.0A, V<sub>GS</sub> = -12V
- ③ I<sub>SD</sub> ≤ -4.0A, di/dt ≤ -150A/μs,  
VDD ≤ -200V, T<sub>J</sub> ≤ 150°C
- ④ Pulse width ≤ 300 μs; Duty Cycle ≤ 2%
- ⑤ **Total Dose Irradiation with V<sub>GS</sub> Bias.**  
-12 volt V<sub>GS</sub> applied and V<sub>DS</sub> = 0 during irradiation per MIL-STD-750, method 1019, condition A.
- ⑥ **Total Dose Irradiation with V<sub>DS</sub> Bias.**  
-160 volt V<sub>DS</sub> applied and V<sub>GS</sub> = 0 during irradiation per MIL-STD-750, method 1019, condition A.

## Case Outline and Dimensions — TO-205AF(Modified TO-39)

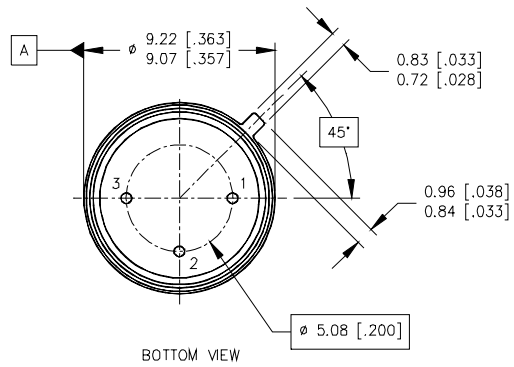
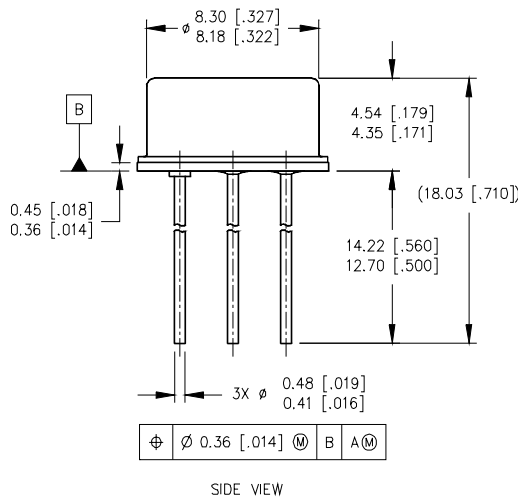

### NOTES:

1. DIMENSIONING AND TOLERANCING PER ASME 14.5M-1994.
2. DIMENSIONS ARE SHOWN IN MILLIMETERS [INCHES].
3. CONTROLLING DIMENSION: INCH.
4. CONFORMS TO JEDEC OUTLINE TO-205AF (TO-39).

### LEGEND

- 1- SOURCE
- 2- GATE
- 3- DRAIN

International  
**IR** Rectifier

IR WORLD HEADQUARTERS: 233 Kansas St., El Segundo, California 90245, USA Tel: (310) 252-7105  
TAC Fax: (310) 252-7903

Visit us at [www.irf.com](http://www.irf.com) for sales contact information.  
Data and specifications subject to change without notice. 02/03