

**REPETITIVE AVALANCHE AND dv/dt RATED
 HEXFET® TRANSISTORS
 THRU-HOLE (TO-204AA/AE)**

**IRF150
 JANTX2N6764
 JANTXV2N6764
 [REF:MIL-PRF-19500/543]
 100V, N-CHANNEL**

Product Summary

Part Number	BVDSS	RDS(on)	ID
IRF150	100V	0.055Ω	38A

The HEXFET® technology is the key to International Rectifier's advanced line of power MOSFET transistors. The efficient geometry and unique processing of this latest "State of the Art" design achieves: very low on-state resistance combined with high transconductance; superior reverse energy and diode recovery dv/dt capability.

The HEXFET transistors also feature all of the well established advantages of MOSFETs such as voltage control, very fast switching, ease of paralleling and temperature stability of the electrical parameters.

They are well suited for applications such as switching power supplies, motor controls, inverters, choppers, audio amplifiers and high energy pulse circuits.



Features:

- Repetitive Avalanche Ratings
- Dynamic dv/dt Rating
- Hermetically Sealed
- Simple Drive Requirements
- Ease of Paralleling

Absolute Maximum Ratings

	Parameter		Units
ID @ VGS = 10V, TC = 25°C	Continuous Drain Current	38	A
ID @ VGS = 10V, TC = 100°C	Continuous Drain Current	24	
IDM	Pulsed Drain Current ①	152	
PD @ TC = 25°C	Max. Power Dissipation	150	W
	Linear Derating Factor	1.2	W/°C
VGS	Gate-to-Source Voltage	±20	V
EAS	Single Pulse Avalanche Energy ②	150	mJ
IAR	Avalanche Current ①	38	A
EAR	Repetitive Avalanche Energy ①	15	mJ
dv/dt	Peak Diode Recovery dv/dt ③	5.5	V/ns
TJ	Operating Junction	-55 to 150	°C
TSTG	Storage Temperature Range		
	Lead Temperature	300 (0.063 in. (1.6mm) from case for 10s)	
	Weight	11.5 (typical)	g

For footnotes refer to the last page

Electrical Characteristics @ T_j = 25°C (Unless Otherwise Specified)

	Parameter	Min	Typ	Max	Units	Test Conditions
BV _{DSS}	Drain-to-Source Breakdown Voltage	100	—	—	V	V _{GS} = 0V, I _D = 1.0mA
ΔBV _{DSS} /ΔT _J	Temperature Coefficient of Breakdown Voltage	—	0.13	—	V/°C	Reference to 25°C, I _D = 1.0mA
R _{DS(on)}	Static Drain-to-Source On-State Resistance	—	—	0.055	Ω	V _{GS} = 10V, I _D = 24A④
		—	—	0.065		V _{GS} = 10V, I _D = 38A ④
V _{GS(th)}	Gate Threshold Voltage	2.0	—	4.0	V	V _{DS} = V _{GS} , I _D = 250μA
g _{fs}	Forward Transconductance	9.0	—	—	S (r̄)	V _{DS} > 15V, I _{DS} = 24A④
I _{DSS}	Zero Gate Voltage Drain Current	—	—	25	μA	V _{DS} = 80V, V _{GS} = 0V
		—	—	250		V _{DS} = 80V V _{GS} = 0V, T _J = 125°C
I _{GSS}	Gate-to-Source Leakage Forward	—	—	100	nA	V _{GS} = 20V
I _{GSS}	Gate-to-Source Leakage Reverse	—	—	-100	nA	V _{GS} = -20V
Q _g	Total Gate Charge	50	—	125	nC	V _{GS} = 10V, I _D = 38A V _{DS} = 50V
Q _{gs}	Gate-to-Source Charge	8.0	—	22		
Q _{gd}	Gate-to-Drain ('Miller') Charge	25	—	65		
t _{d(on)}	Turn-On Delay Time	—	—	35	ns	V _{DD} = 50V, I _D = 38A, V _{GS} = 10V, R _G = 2.35Ω
t _r	Rise Time	—	—	190		
t _{d(off)}	Turn-Off Delay Time	—	—	170		
t _f	Fall Time	—	—	130		
L _S + L _D	Total Inductance	—	6.1	—	nH	Measured from the center of drain pad to center of source pad
C _{iss}	Input Capacitance	—	3700	—	pF	V _{GS} = 0V, V _{DS} = 25V f = 1.0MHz
C _{oss}	Output Capacitance	—	1100	—		
C _{rss}	Reverse Transfer Capacitance	—	200	—		

Source-Drain Diode Ratings and Characteristics

	Parameter	Min	Typ	Max	Units	Test Conditions
I _S	Continuous Source Current (Body Diode)	—	—	38	A	
I _{SM}	Pulse Source Current (Body Diode) ①	—	—	152		
V _{SD}	Diode Forward Voltage	—	—	1.9	V	T _j = 25°C, I _S = 38A, V _{GS} = 0V ④
t _{rr}	Reverse Recovery Time	—	—	500	rS	T _j = 25°C, I _F = 38A, di/dt ≤ 100A/μs
Q _{RR}	Reverse Recovery Charge	—	—	2.9	μC	V _{DD} ≤ 30V ④
t _{on}	Forward Turn-On Time	Intrinsic turn-on time is negligible. Turn-on speed is substantially controlled by L _S + L _D .				

Thermal Resistance

	Parameter	Min	Typ	Max	Units	Test Conditions
R _{thJC}	Junction to Case	—	—	0.83	°C/W	Typical socket mount
R _{thJA}	Junction to Ambient	—	—	30		

For footnotes refer to the last page

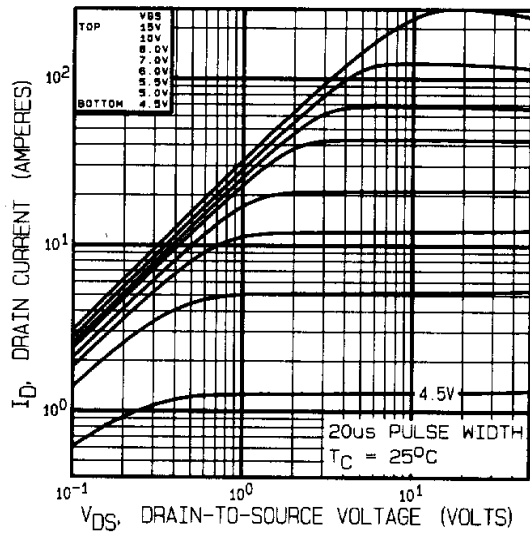

Fig 1. Typical Output Characteristics

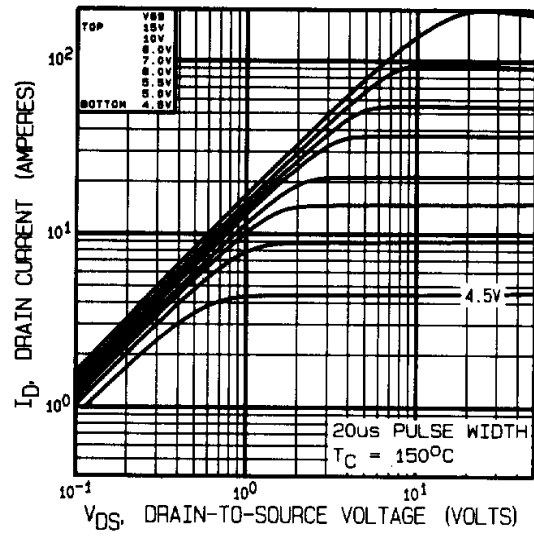

Fig 2. Typical Output Characteristics

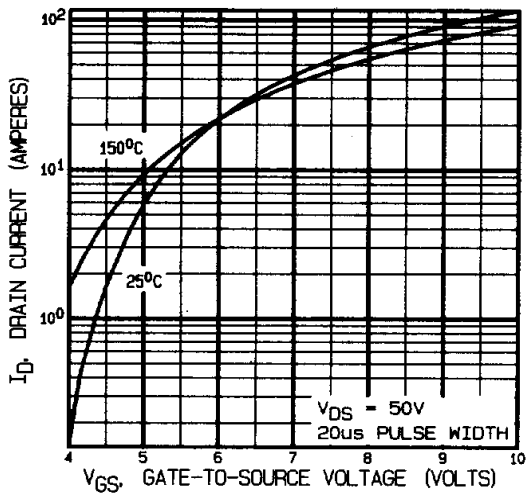

Fig 3. Typical Transfer Characteristics

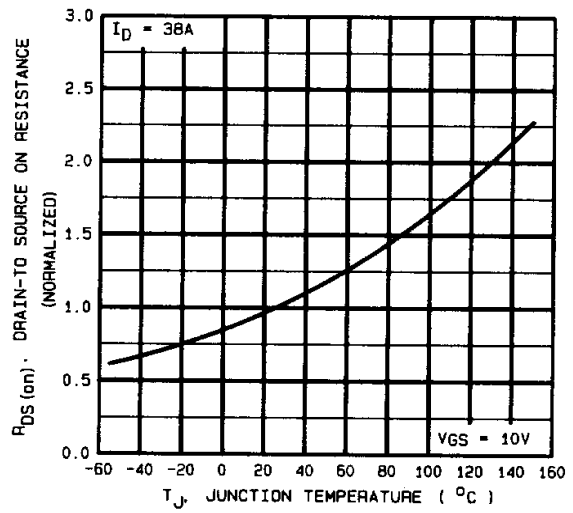

Fig 4. Normalized On-Resistance Vs. Temperature

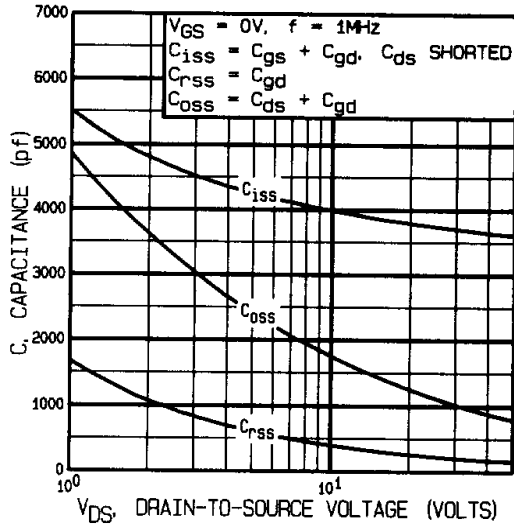

Fig 5. Typical Capacitance Vs. Drain-to-Source Voltage

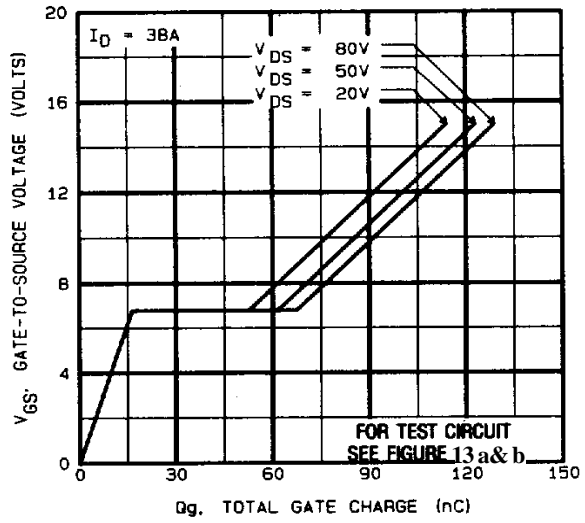

Fig 6. Typical Gate Charge Vs. Gate-to-Source Voltage

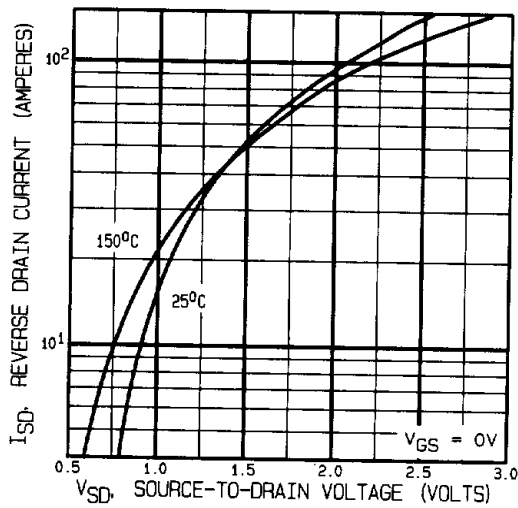

Fig 7. Typical Source-Drain Diode Forward Voltage

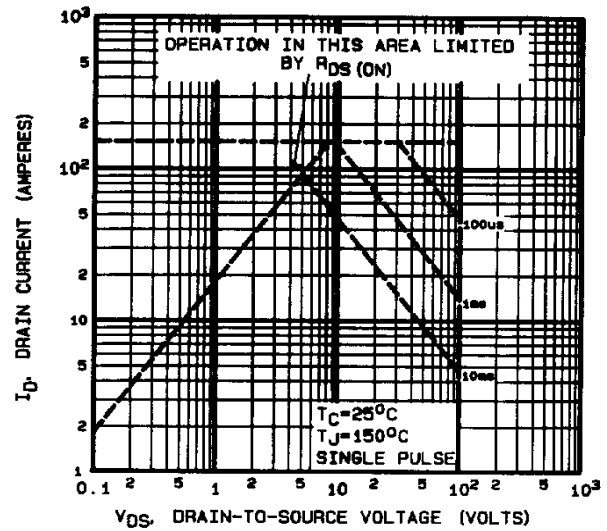

Fig 8. Maximum Safe Operating Area

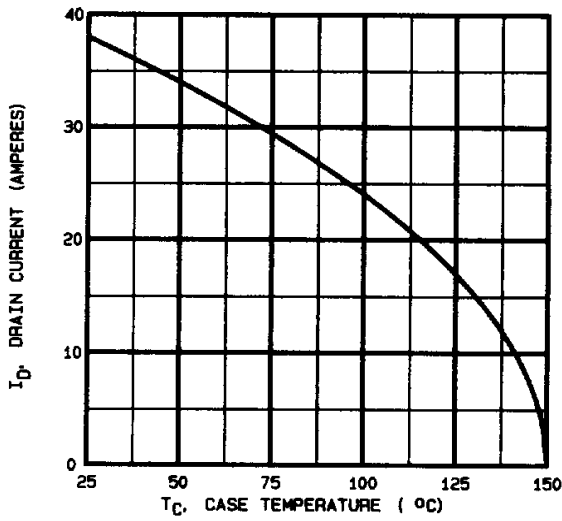

Fig 9. Maximum Drain Current Vs. Case Temperature

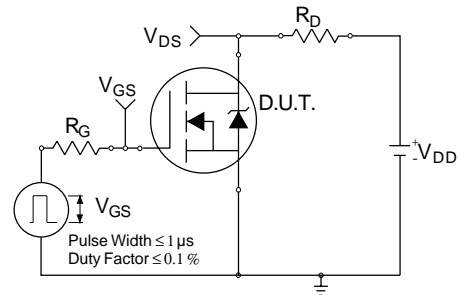

Fig 10a. Switching Time Test Circuit

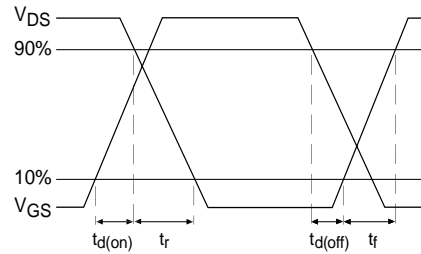

Fig 10b. Switching Time Waveforms

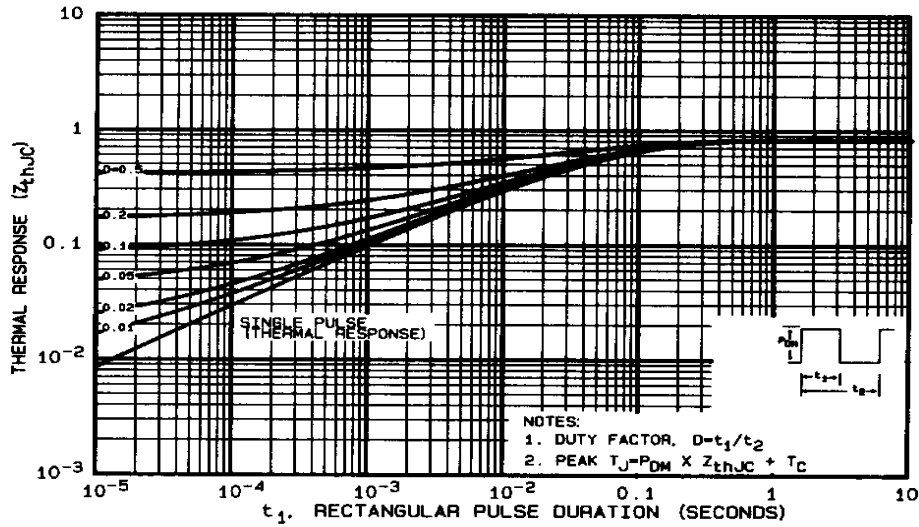

Fig 11. Maximum Effective Transient Thermal Impedance, Junction-to-Case

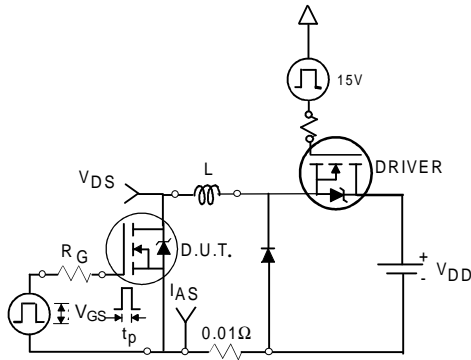

Fig 12a. Unclamped Inductive Test Circuit

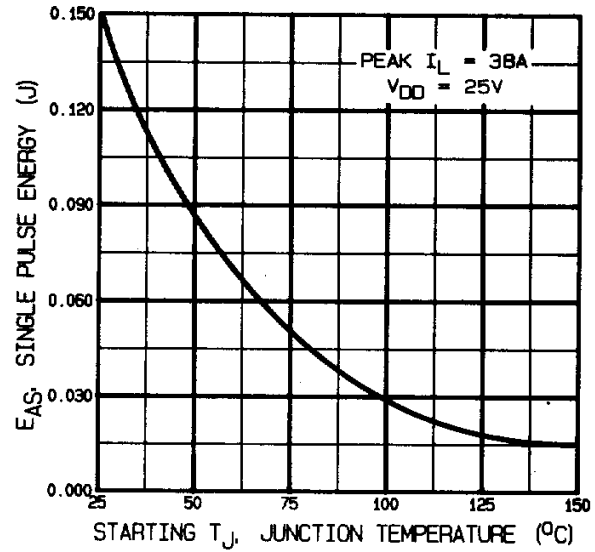

Fig 12c. Maximum Avalanche Energy Vs. Drain Current

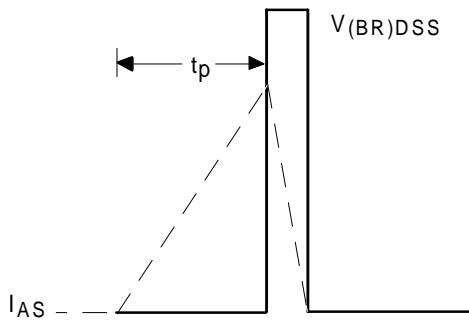

Fig 12b. Unclamped Inductive Waveforms

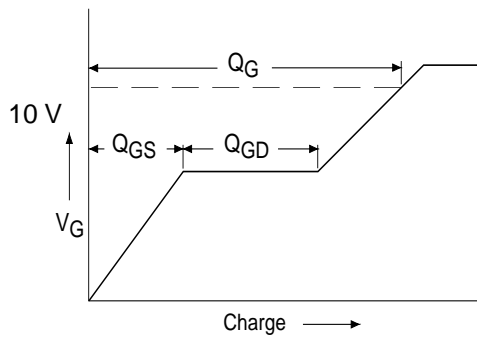

Fig 13a. Basic Gate Charge Waveform

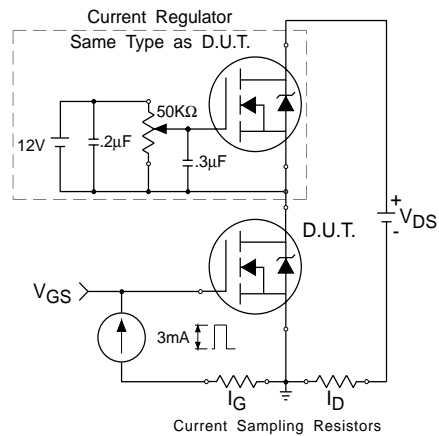
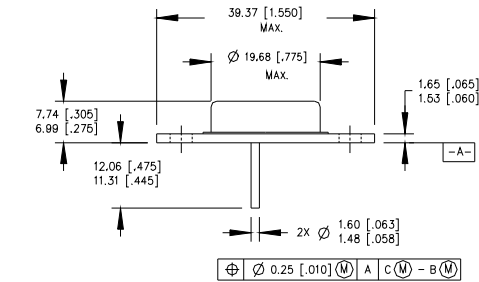

Fig 13b. Gate Charge Test Circuit

Foot Notes:

- ① Repetitive Rating; Pulse width limited by maximum junction temperature.
- ② $V_{DD} = 50V$, starting $T_J = 25^\circ C$,
Peak $I_L = 38A$, $V_{GS} = 10V$
- ③ $I_{SD} \leq 38A$, $di/dt \leq 300A/\mu s$,
 $V_{DD} \leq 100V$, $T_J \leq 150^\circ C$
Suggested $R_G = 2.35 \Omega$
- ④ Pulse width $\leq 300 \mu s$; Duty Cycle $\leq 2\%$

Case Outline and Dimensions —TO-204AE (Modified TO-3)



PIN ASSIGNMENTS

- 1 - SOURCE
- 2 - GATE
- 3 - DRAIN (CASE)

NOTES:

1. DIMENSIONING & TOLERANCING PER ANSI Y14.6M-1982.
2. CONTROLLING DIMENSION: INCH.
3. DIMENSIONS ARE SHOWN IN MILLIMETERS [INCHES].
4. OUTLINE CONFORMS TO JEDEC OUTLINE TO-204AE.

