

JUMBO BUTTON AUTOMOTIVE RECTIFIER

JAR7005 THRU JAR706

VOLTAGE RANGE 50 to 600 Volts

CURRENT 70.0 Amperes

FEATURES

- Low Leakage
- Low forward voltage drop
- High current capability
- High forward surge current capacity

MECHANICAL DATA

- Case: transfer molded plastic
- Epoxy: UL94V-0 rate flame retardant
- Lead: Plated slug , solderable per MIL-STD-202E method 208C
- Polarity: Color ring denotes cathode end
- Mounting Position: any
- Weight: 0.085 ounces, 2.40 grams

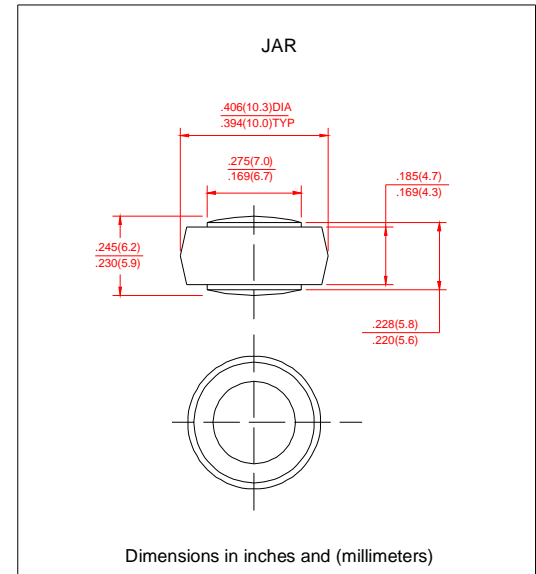

MAXIMUM RATINGS AND ELECTRICAL CHARACTERISTICS

- Ratings at 25°C ambient temperature unless otherwise specified
- Single Phase, half wave, 60HZ, resistive or inductive load
- For capacitive load derate current by 20%

	SYMBOLS	JAR7005	JAR701	JAR702	JAR704	JAR706	UNIT
Maximum Repetitive Peak Reverse Voltage	V_{RRM}	50	100	200	400	600	Volts
Maximum RMS Voltage	V_{RMS}	35	70	140	280	420	Volts
Maximum DC Blocking Voltage	V_{DC}	50	100	200	400	600	Volts
Maximum Average Forward Rectified Current, At $T_c=110^\circ\text{C}$	I_O	70.0					Amps
Peak Forward Surge Current 3.3mS single half sine wave superimposed on Rated load (JEDEC method)	I_{FSM}	700					Amps
Maximum instantaneous Forward Voltage at 100A	V_F	1.05					Volts
Maximum DC Reverse Current at Rated $T_A=25^\circ\text{C}$ DC Blocking Voltage per element $T_A=100^\circ\text{C}$	I_R	5.0					UA
		400					
Typical Thermal Resistance	$R_{\theta JC}$	0.8					$^\circ\text{C}/\text{W}$
Operating and Storage Temperature Range	T_J, T_{STG}	(-65 to +175)					$^\circ\text{C}$
Polarity and voltage demotion color band		Red	Yellow	Silver	Orange	Green	

Notes:

1. Enough heatsink must be considered in application.



JUMBO BUTTON AUTOMOTIVE RECTIFIER

JAR7005 THRU JAR706

VOLTAGE RANGE 50 to 600 Volts

CURRENT 70.0 Amperes

RATINGS AND CHARACTERISTIC CURVES JAR7005 THRU JAR706

F1G.1 TYPICAL FORWARD CURRENT DERATING CURVE

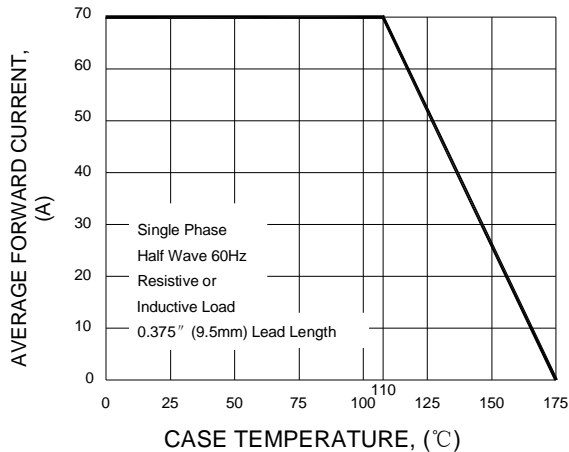

F1G.2 MAXIMUM NON-REPETITIVE PEAK FORWARD SURGE CURRENT

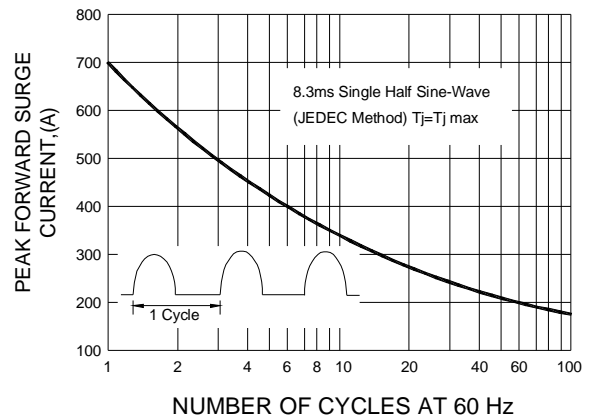

F1G.3 TYPICAL INSTANTANEOUS FORWARD CHARACTERISTICS

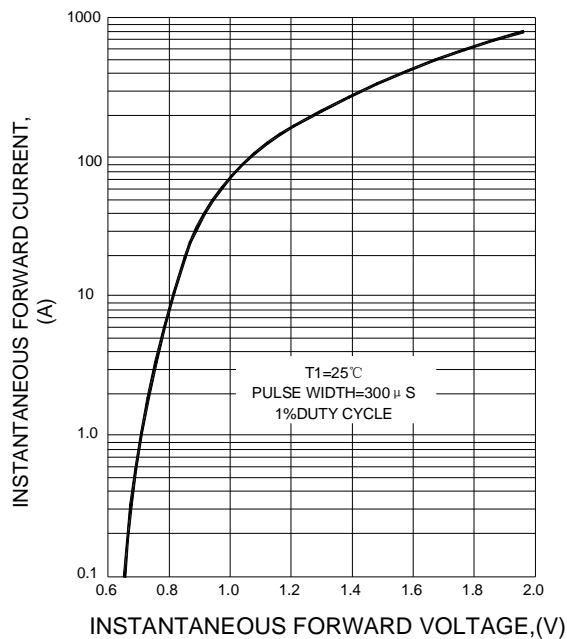

F1G.4 FORWARD POWER DISSIPATION

