

DUAL HIGH CURRENT OPERATIONAL AMPLIFIER

■ GENERAL DESCRIPTION

The NJM4556A integrated circuit is a high-gain, high output current dual operational amplifier capable of driving $\pm 70\text{mA}$ into 150Ω loads ($\pm 10.5\text{V}$ output voltage), and operating low supply voltage ($V^+V^-=\pm 2\text{V}\sim$).

The NJM4556A combines many of the features of the popular NJM4558 as well as having the capability of driving 150Ω loads. In addition, the wide band-width, low noise, high slew rate and low distortion of the NJM4556A make it ideal for many audio, telecommunications and instrumentation applications.

■ FEATURES

- Operating Voltage ($\pm 2\text{V}\sim\pm 18\text{V}$)
- High Output Current ($I_o=70\text{mA}$)
- Slew Rate ($3\text{V}/\mu\text{s}$ typ.)
- Gain Band Width Product (8MHz typ.)
- Equivalent Input Noise Voltage ($10\text{nV}/\sqrt{\text{Hz}}$ typ.)
- Package Outline DIP8, DMP8, SIP8, SSOP8
- Bipolar Technology

■ PACKAGE OUTLINE

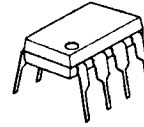

NJM4556AD



NJM4556AM



NJM4556AV

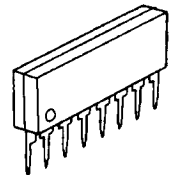

NJM4556AL

■ PIN CONFIGURATION

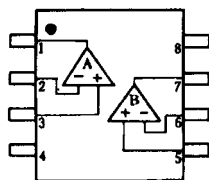

NJM4556AD
NJM4556AM
NJM4556AV

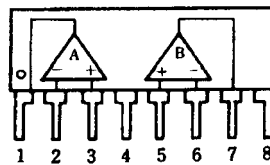

NJM4556AL

- PIN FUNCTION**
- 1.A OUTPUT
 - 2.A -INPUT
 - 3.A +INPUT
 - 4.V⁻
 - 5.B +INPUT
 - 6.B -INPUT
 - 7.B OUTPUT
 - 8.V⁺

■ EQUIVALENT CIRCUIT (1/2 Shown)

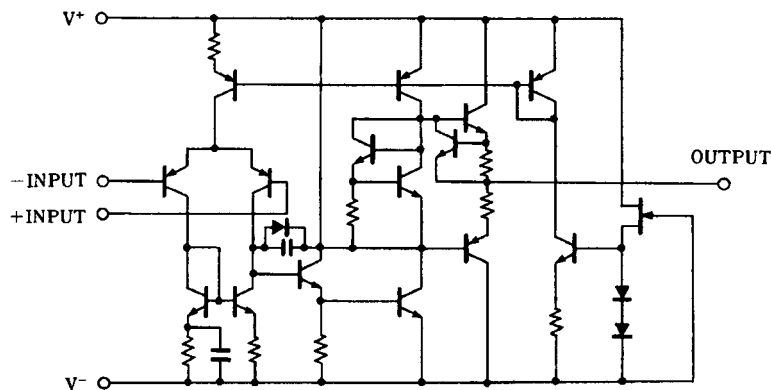

NJM4556A

■ ABSOLUTE MAXIMUM RATINGS

(Ta=25°C)

PARAMETER	SYMBOL	RATINGS	UNIT
Supply Voltage	V^+ / V^-	± 18	V
Differential Input Voltage	V_{ID}	± 30	V
Input Voltage	V_{IC}	± 15 (note)	V
Power Dissipation	P_D	(DIP8) 700 (DMP8) 300 (SSOP8) 250 (SIP8) 800	mW
Operating Temperature Range	T_{opr}	-40~+85	°C
Storage Temperature Range	T_{stg}	-40~+125	°C

(note) For supply voltage less than ±15V, the absolute maximum input voltage is equal to the supply voltage.

■ ELECTRICAL CHARACTERISTICS (NJM4556AD / NJM4556AL)

($V^+ / V^- = \pm 15V, Ta = 25^\circ C$)

PARAMETER	SYMBOL	TEST CONDITION	MIN.	TYP.	MAX.	UNIT
Input Offset Voltage	V_{IO}	$R_S \leq 10k\Omega$	-	0.5	6.0	mV
Input Offset Current	I_{IO}		-	5	60	nA
Input Bias Current	I_B		-	50	500	nA
Input Resistance	R_{IN}		0.3	5	-	MΩ
Large Signal Voltage Gain	A_V	$R_L \geq 2k\Omega, V_O = \pm 10V$	86	100	-	dB
Maximum Output Voltage Swing 1	V_{OM1}	$R_L \geq 2k\Omega$	± 12	± 13.5	-	V
Maximum Output Voltage Swing 2	V_{OM2}	$R_L \geq 150\Omega$	± 10.5	± 11	-	V
Input Common Mode Voltage Range	V_{ICM}		± 13.5	± 14	-	V
Common Mode Rejection Ratio	CMR	$R_S \leq 10k\Omega$	70	90	-	dB
Supply Voltage Rejection Ratio	SVR	$R_S \leq 10k\Omega$	76.5	90	-	dB
Operating Current	I_{CC}		-	9	12	mA
Slew Rate	SR		-	3	-	V/μs
Gain Bandwidth Product	GB		-	8	-	MHz

■ ELECTRICAL CHARACTERISTICS (NJM4556AM / NJM4556AV)

($V^+ / V^- = \pm 15V, Ta = 25^\circ C$)

PARAMETER	SYMBOL	TEST CONDITION	MIN.	TYP.	MAX.	UNIT
Input Offset Voltage	V_{IO}	$R_S \leq 10k\Omega$	-	0.5	6.0	mV
Input Offset Current	I_{IO}		-	5	60	nA
Input Bias Current	I_B		-	50	500	nA
Large Signal Voltage Gain	A_V	$R_L \geq 2k\Omega, V_O = \pm 10V$	86	100	-	dB
Maximum Output Voltage Swing 1	V_{OM1}	$V_{IN}^+ = 4V, V_{IN}^- = 3V, V^+ = 9V, V^- = 0V$ $I_{SOURCE} = 40mA$	7.5	-	-	V
Maximum Output Voltage Swing 2	V_{OM2}	$V_{IN}^+ = 3V, V_{IN}^- = 4V, V^+ = 9V, V^- = 0V$ $I_{SINK} = 40mA$	-	-	2.1	V
Input Common Mode Voltage Range 1	V_{ICM1}	$V^+ = 9V, V^- = 0V, V_{IL}$	-	-	1.5	V
Input Common Mode Voltage Range 2	V_{ICM2}	$V^+ = 9V, V^- = 0V, V_{IH}$	8	-	-	V
Common Mode Rejection Ratio	CMR	$R_S \leq 10k\Omega$	70	90	-	dB
Supply Voltage Rejection Ratio	SVR	$R_S \leq 10k\Omega$	76.5	90	-	dB
Supply Current	I_{CC}	$V^+ = 9V, V^- = 0V$	-	8	12	mA
Slew Rate	SR		-	3	-	V/μs
Gain Bandwidth Product	GB		-	8	-	MHz

■ TYPICAL CHARACTERISTICS

Maximum Output Voltage Swing vs. Frequency

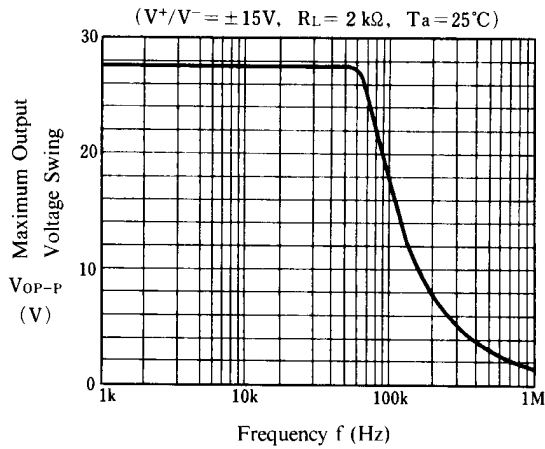

Maximum Output Voltage Swing vs. Frequency

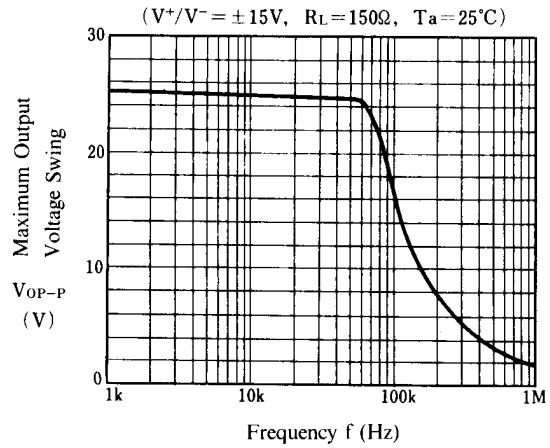

Maximum Output Voltage Swing vs. Output Current

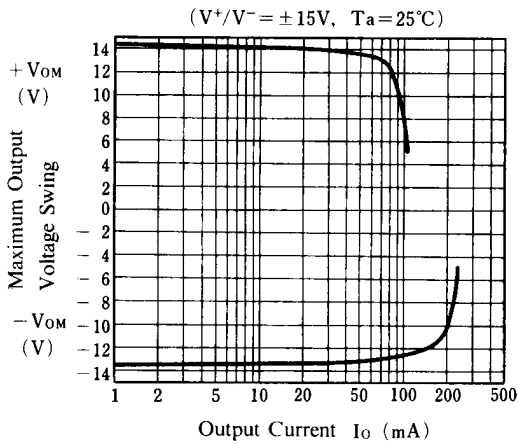

Voltage Gain, Phase Shift vs. Frequency

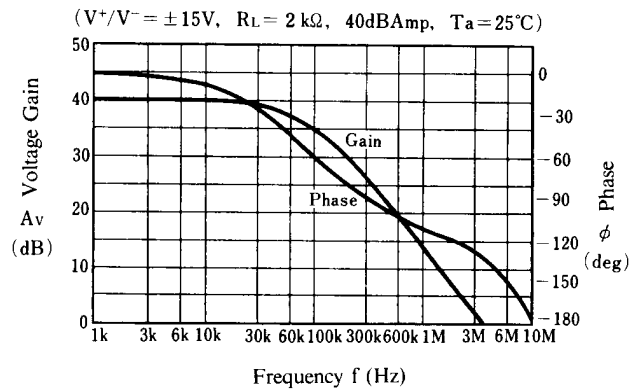

Maximum Output Voltage Swing vs. Operating Voltage

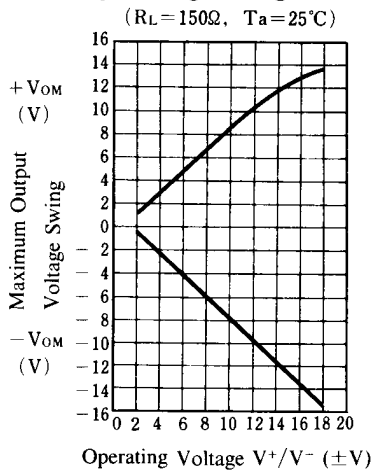

Total Harmonic Distortion vs. Output Voltage

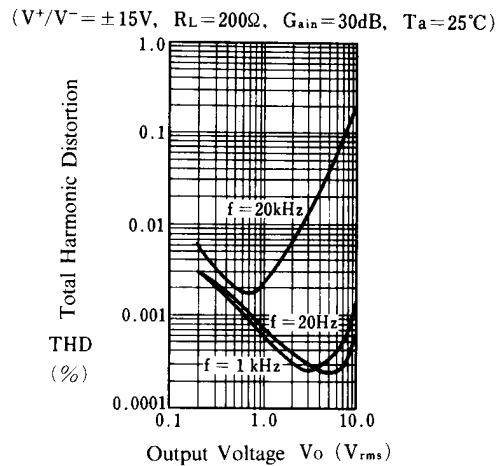

■ TYPICAL CHARACTERISTICS

Maximum Output Voltage Swing vs. Temperature
($V^+/V^- = \pm 15V$, $R_L = 2\text{ k}\Omega$)

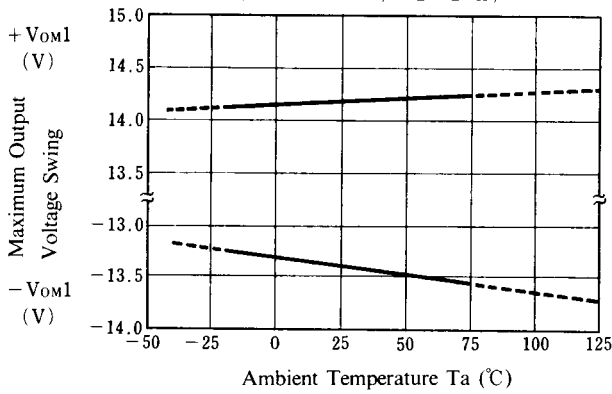

Maximum Output Voltage Swing vs. Temperature
($V^+/V^- = \pm 15V$, $R_L = 150\Omega$)

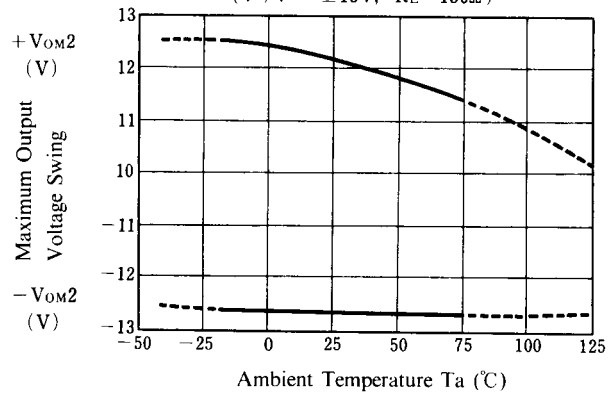

Input Offset Voltage vs. Temperature
($V^+/V^- = \pm 15V$)

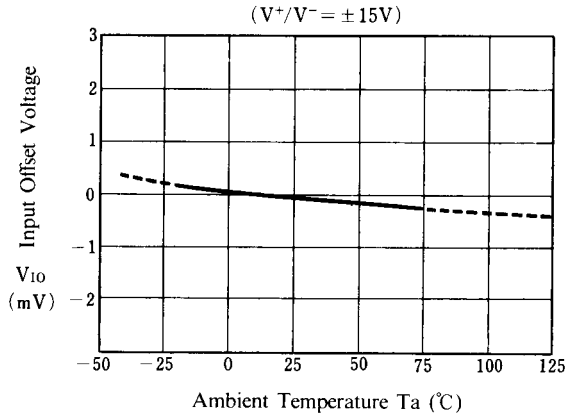

Supply Current vs. Temperature
($V^+/V^- = \pm 15V$)

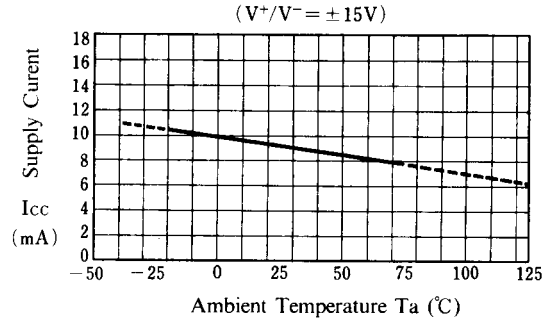

Equivalent Input Noise Voltage vs. Frequency
($V^-/V^+ = \pm 15V$, $R_s = 100\Omega$, $A_v = 40\text{dB}$, $T_a = 25^\circ\text{C}$)

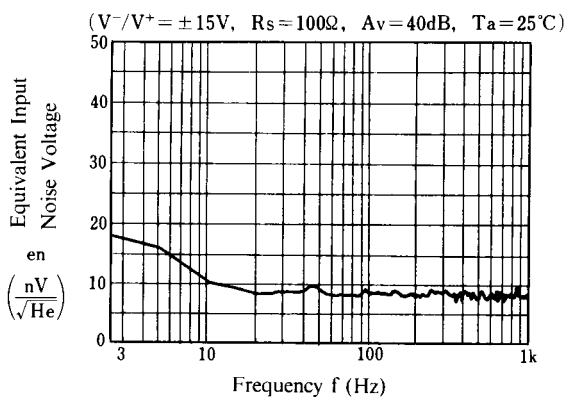

Operating Current vs. Operating Voltage
($T_a = 25^\circ\text{C}$)

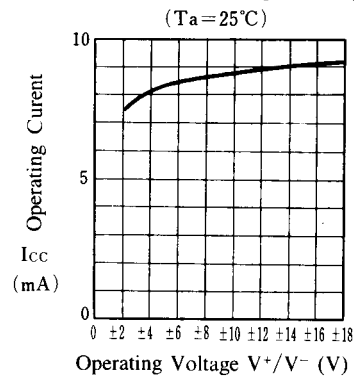

[CAUTION]

The specifications on this databook are only given for information, without any guarantee as regards either mistakes or omissions. The application circuits in this databook are described only to show representative usages of the product and not intended for the guarantee or permission of any right including the industrial rights.