

# Specification

**Product Model: JD567M03-AT056TN52 V.3**

**Driver Board's Version: VER:1.02**

**LCD Screen's Model: AT056TN52 V.3**

USER			MANUFACTURER		
QA	Project	Approved by	Prepared by	Checked by	Approved by

## Catalogue

Content .....	2
Version .....	3
1. Profile .....	4
2. Main parameter .....	4
3. Product picture .....	4
4. Wiring diagram .....	5-6
5. Connector definition of driver board .....	6-7
6. Structural diagram .....	8-9
7. Product logo .....	10
8. Packing & shipping .....	10
9. Caution .....	10
10.5.6"TFT- LCD PANEL Inspection standard .....	11-12

### Version

Date	Version	Content
2011-6-15	RD001	The First Version
2011-7-13	VER:1.00	The Second Version
2012-6-1	VER:1.01	The Third Version(optimize circuit)
2012-8-30	VER:1.02	The Fourth Version(increase power light circuit)

### 1. Profile:

JD567M03 VER:1.02-AT056TN52 V.3 Color digital module is composed by JD567M03 VER:1.02 driver board and AT056TN52 V.3 Lcd panel . it can input CVBS、VGA signal . with PAL and NTSC (auto switch), pushbutton adjustment , OSD menu display , it is main used for video door phone and other display equipments .

### 2.Main Parameter:

No.	Item	Description	Remarks
1	LCD display size	5.6 inch	
2	LCD aspect ratio	4:3	
3	backlight	LED	
4	Brightness	200±50 cd/m <sup>2</sup>	
5	Resolution	640×(RGB)×480	
6	View angle(U、 D、 L、 R)	(50/70/70/70)	
7	LCD screen dimension	126.5 (W) ×100 (H) ×5.7 (D) mm	
8	Effective display area	112.896 ( W ) ×84.672 ( H ) mm	
9	Driver board dimension	102.0 (W)×50.0(H) × 6.8 (D) mm	
10	Working voltage (Power supply <=0.3VP-P)	Min: DC9V; S: DC12V; Max: DC15V;	
11	Working current (DC 12V power supply)	DC200mA±20mA	
12	Power consume	2.4W (TYP)	
13	Start time	2.5s	
14	Operation temperature	0°C~60°C	
15	Storage temperature	-20°C~70°C	
16	Relative humidity	5~95%RH	

### 3.Product picture:



### 4.Wiring Diagram:

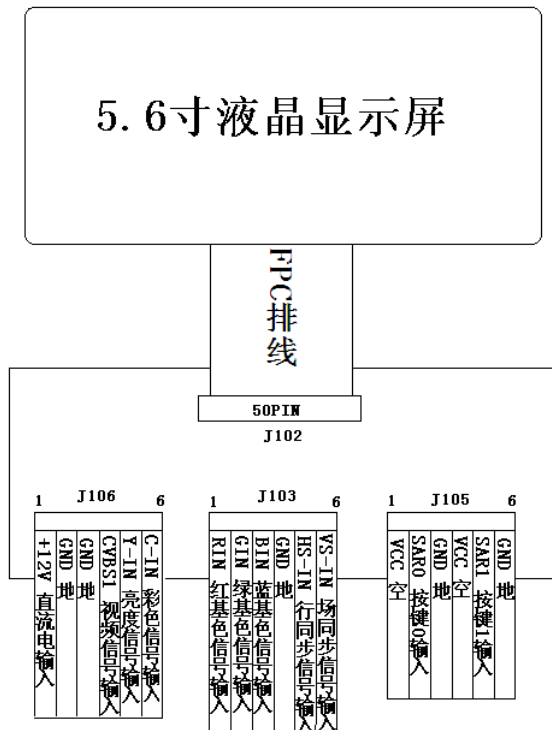

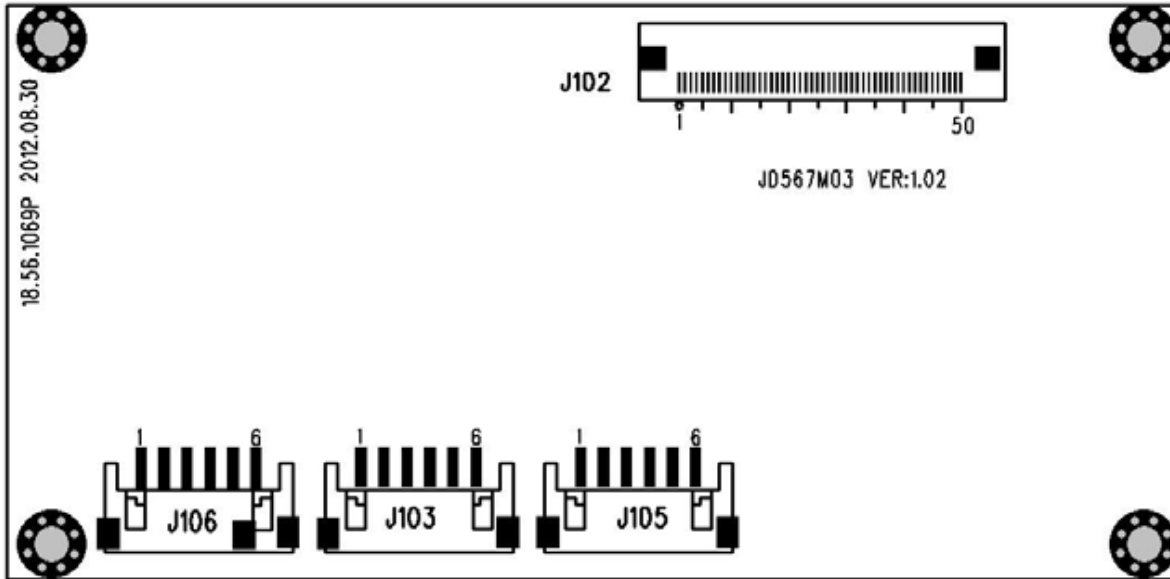

### 5.Connector definition of driver board:

#### 5.1 J106:

Pin No.	Symbol	I/O	Description	Remarks
1	+12VIN	I	DC12V input	
2	GND	-	Ground	
3	GND	-	Ground	
4	VIDEO	I	Video input	
5	Y-IN	I	Brightness input	
6	C-IN	I	Color input	

#### 5.2 J103:

Pin No.	Symbol	I/O	Description	Remarks
1	RIN	I	Red primary color signal input	
2	GIN	I	Green primary color signal input	
3	BIN	I	Blue primary color signal input	

4	GND	-	Ground
5	HS-IN	I	Line sync signal input
6	VS-IN	I	Field sync signal input

### 5.3 105:

Pin No.	Symbol	I/O	Description	Remarks
1	VCC		No Connect	
2	SAR0	I	Key-press 0 input	
3	GND	-	Ground	
4	VCC		No connect	
5	SAR1	I	Key-press 1 input	
6	GND	-	Ground	

### Pushbutton Board JDKEY VER:1.00:



### Pushbutton board connection diagram:

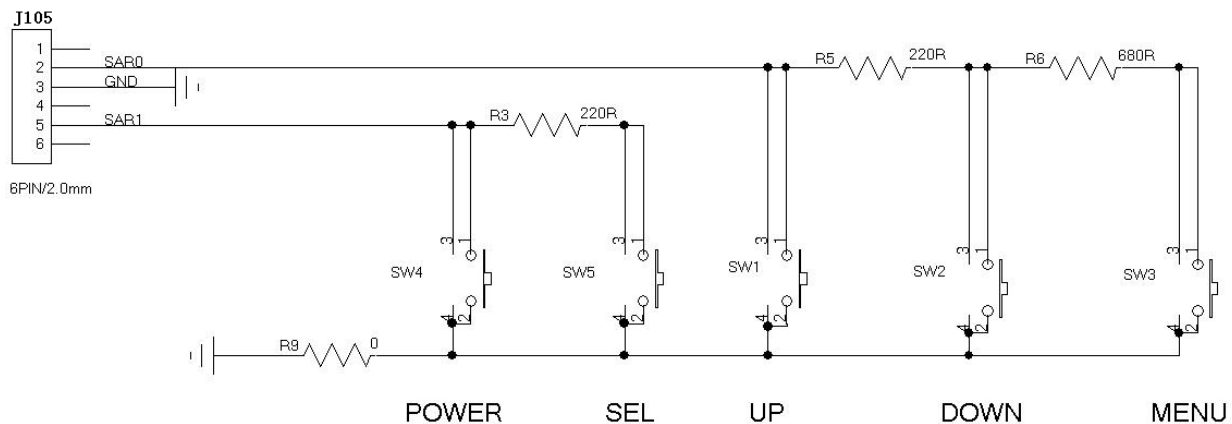

### 6. Structural Diagram:

#### 6.1 TFT LCD Panel:

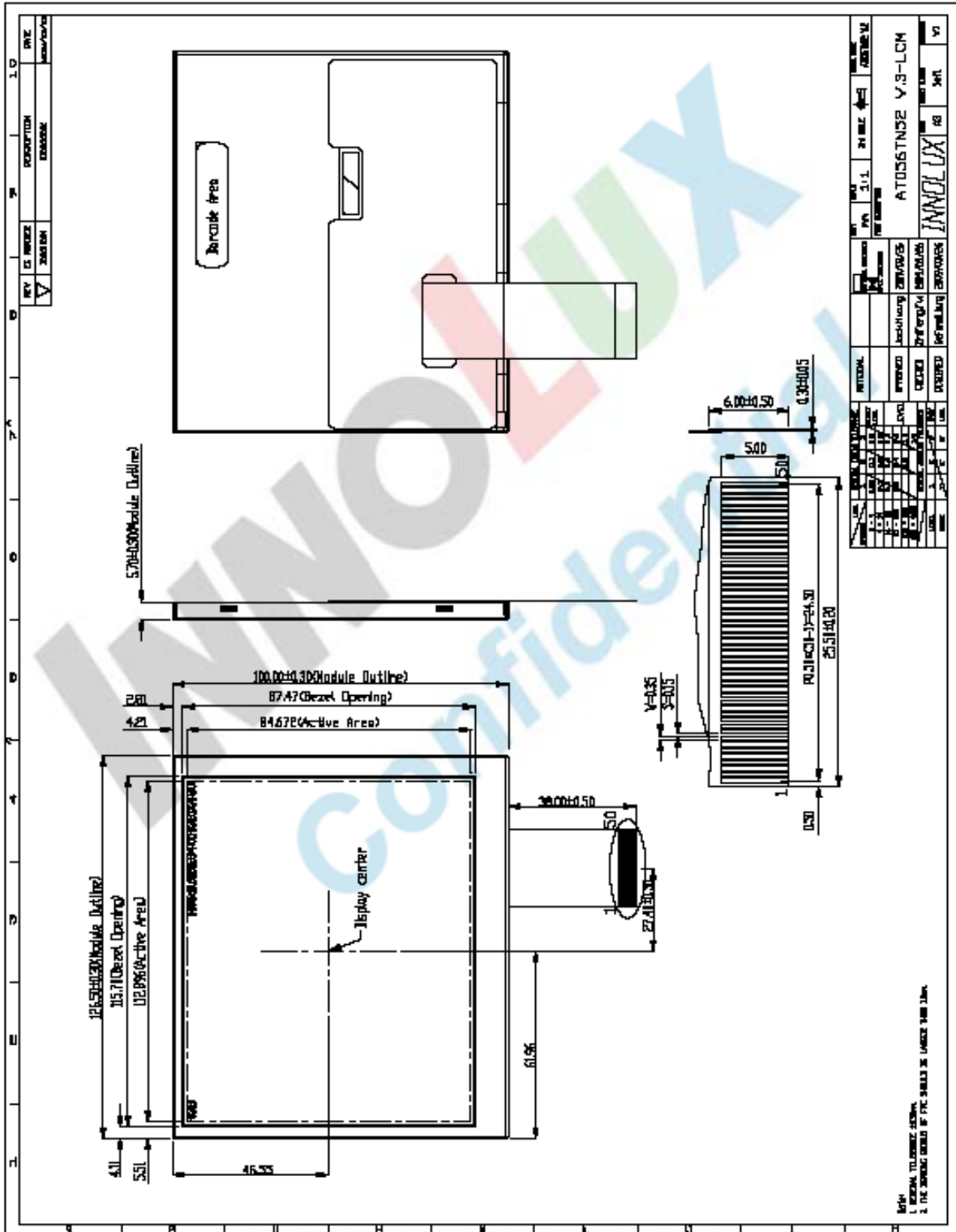



#### 6.2 PCBA dimension: 102.0(W) × 50.0 (H) × 6.8(D)mm

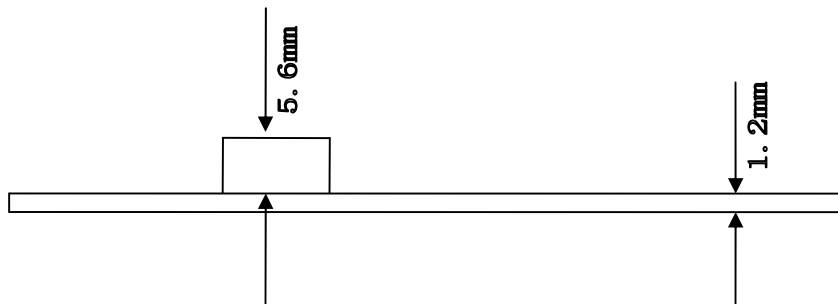
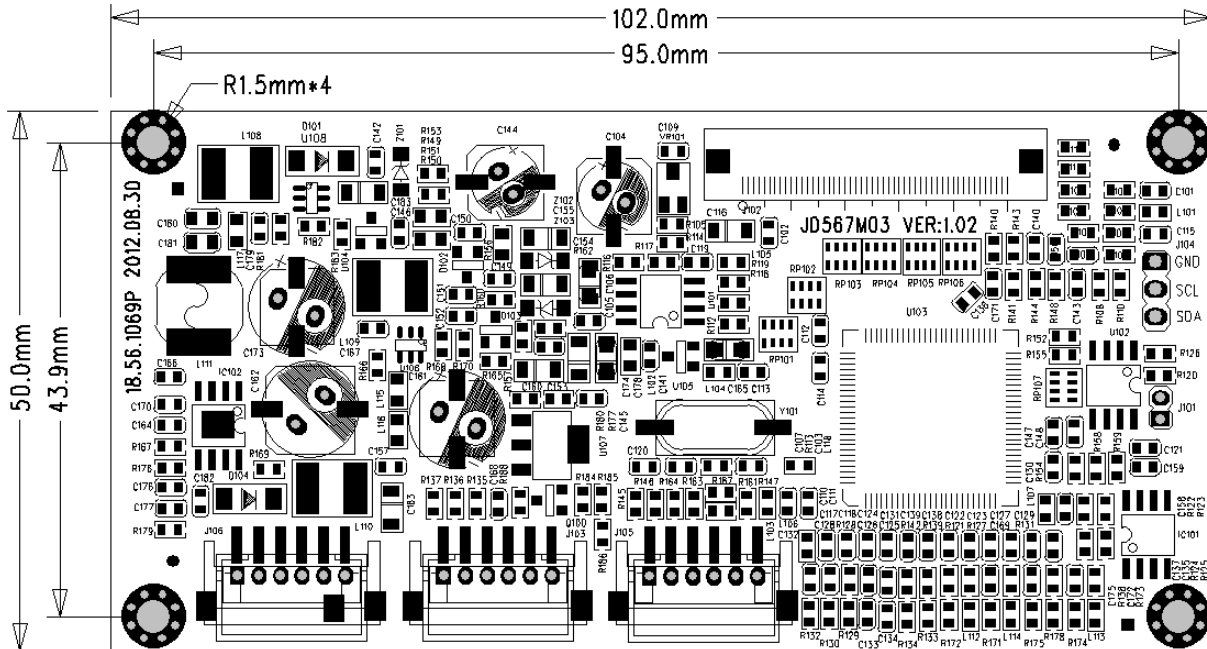

### 7. Product logo:

**AT056TN52 V.3**

### 8. Packing、 shipping and storage

#### 1. Packing

TBD

#### 2.Shipping and Storage

Avoid to crash and drench , chemicals stores with humidity products together that is rigidly prohibited.

### 9. Caution:

1. TFT have used by special instrument to adjust precision and aging、 test before leave factory, no need adjust again.
2. Please correctly connect power、 video signal before you adjust, should be on/off power and video signal to check the image's effect.
3. Due to this product is electronic product, please notice prevent static.
4. 5.6"TFT-LCD Panel is a glasswork, place carefully ,broken for fear.
5. The connection is "FPC", which connect 5.6"TFT-LCD panel with PCB, Please operate it carefully, in order to keep it well.
6. Don't touch pushbutton's pin feet when you adjust pushbuttons, due to person have resistance, you will effect pushbutton's function when touch it.

### 10.5.6" TFT- LCD PANEL Inspection standard:

Aim: Establishing the standard of PANLE for inspecting material & progress and for clients' inspection.

Scope: Apply to 5.6" TFT LCD

Content:

10.1. Inspection standard and method:

10.1.1. The method and determinant of inspecting the nick of panel of LCD:

10.1.1.1. Inspect vertically (or at 45° angle from left/right) under the light tube (the power is 20 W) in the distance of 30cm to the panel. If there is no nick, it is "OK". Otherwise "NG".

10.1.2. The method and determinative for black & white & color spots for the Panel of LCD:

10.1.2.1. Inspection methods

10.1.2.1.1. Black spots: under status of denote light, set the MASK of black spot inspection near the black spot then compare the big and small by eyes.

10.1.2.1.2. White & Color spots: under status of denote light, set the Mask of black spot inspection on the white spot (or color spot) then inspect them by eyes if it can hide.

10.1.2.2. Division of LCD Panel

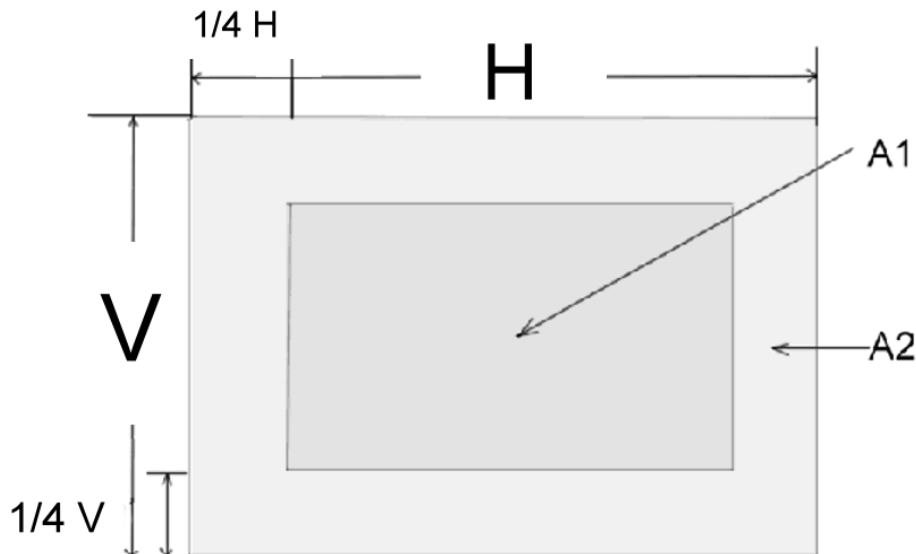

Remark: A1: The center of the available area for the picture

A2: The edge of the available area for the picture (around the central area)

### 10.1.3. The inspection standard for the spots:

Spot Diameter (mm)		Allowed Area	
		A1	A2
Black Spot	$d \leq 0.15$	Irrespective	Irrespective
	$0.15 < d \leq 0.3$	4	4
	$0.3 < d \leq 0.5$	2	3
	$0.5 < d < 0.8$	0	2
White or color spot	$d \leq 0.15$	Irrespective	Irrespective
	$0.15 < d \leq 0.3$	3	3
	$0.3 < d \leq 0.5$	1	2
	$0.5 < d < 0.8$	0	1

- Remark:
1. Size: Average Diameter = (Max. Diameter + Min. Diameter) / 2
  2. Using information above as a standard in order to judge while the spot is a dense.
  3. Black & White spot: To judge the obvious spots through the change of voltage by comparison.
  4. Total quantity of Black & white & color spot:  $A1 + A2 \leq 4$ .