

**SPECIFICATIONS FOR
LCD MODULE**

Module No. JH30240400D

E-mail: sales@jhlcd.com

Website: www.jhlcd.com

TABLE OF CONTENTS

| | |
|--|--------------|
| LCM NUMBER SYSTEM..... | |
| 1.GEBERAL INFORMATION..... | |
| 2.EXTERNAL DIMENSIONS..... | |
| 3.ABSOLUTE MAXIMUM RATINGS..... | |
| 4.ELECTRICAL CHARACTERISTICS..... | |
| 5.SYSTEM INTERFACE..... | |
| 6.BACKLIGHT CHARACTERISTICS..... | |
| 7.INTERFACE DESCRIPTION..... | |
| 8.RELIABILITY TEST..... | |
| 9.INSPECTION CRITERION..... | |
| 10.PRECAUTIONS FOR USING LCD MODULES..... | |
| 11.PACKING SPECIFICATION..... | |
| 12. REVISION HISTORY..... | |
| SAMPLE APPROVED REPORT..... | |

JEWEL HILL

LCM Number System

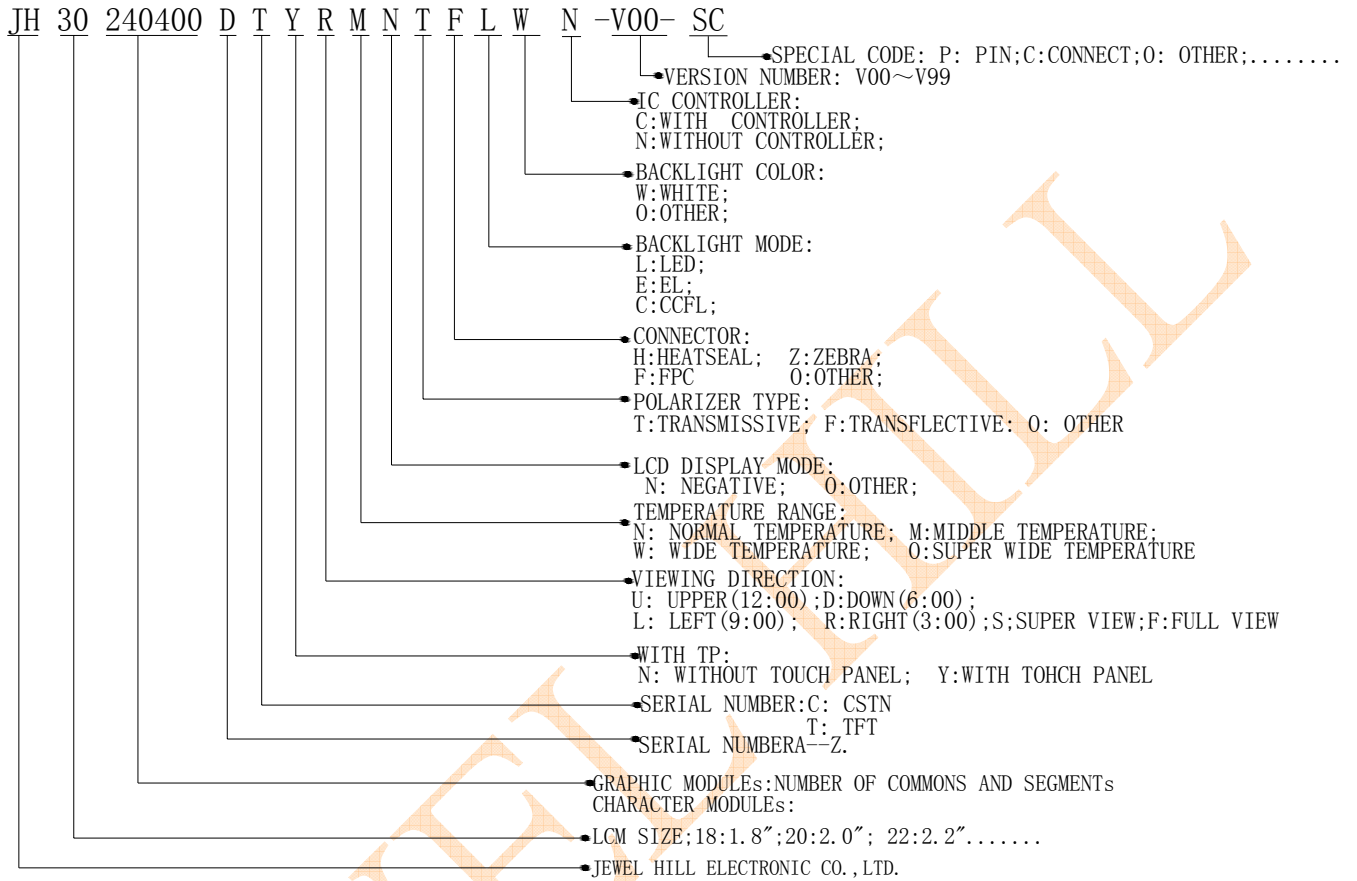

1.GENERAL INFORMATION.

| Item | Display Panel | Remark |
|--------------------|----------------------------------|--------|
| Display Mode | Normally White, Transmissive LCD | - |
| Viewing Direction | 3 O'CLOCK | - |
| Input Signals | 8/16 Bits | - |
| Outside Dimensions | 45.04mm(W)*77.0mm(H)*2.6mm(T) | - |
| Active Area | 38.88mm(W)*64.8mm(H) | - |
| Number of Pixels | 240xRGBx400Pixels | - |
| Pixel Pitch | 0.153mm(H)x0.153mm(W) | - |
| Pixel Arrangement | RGB Vertical stripes | - |
| Drive IC | ILI9326 | - |

2.EXTERNAL DIMENSIONS.

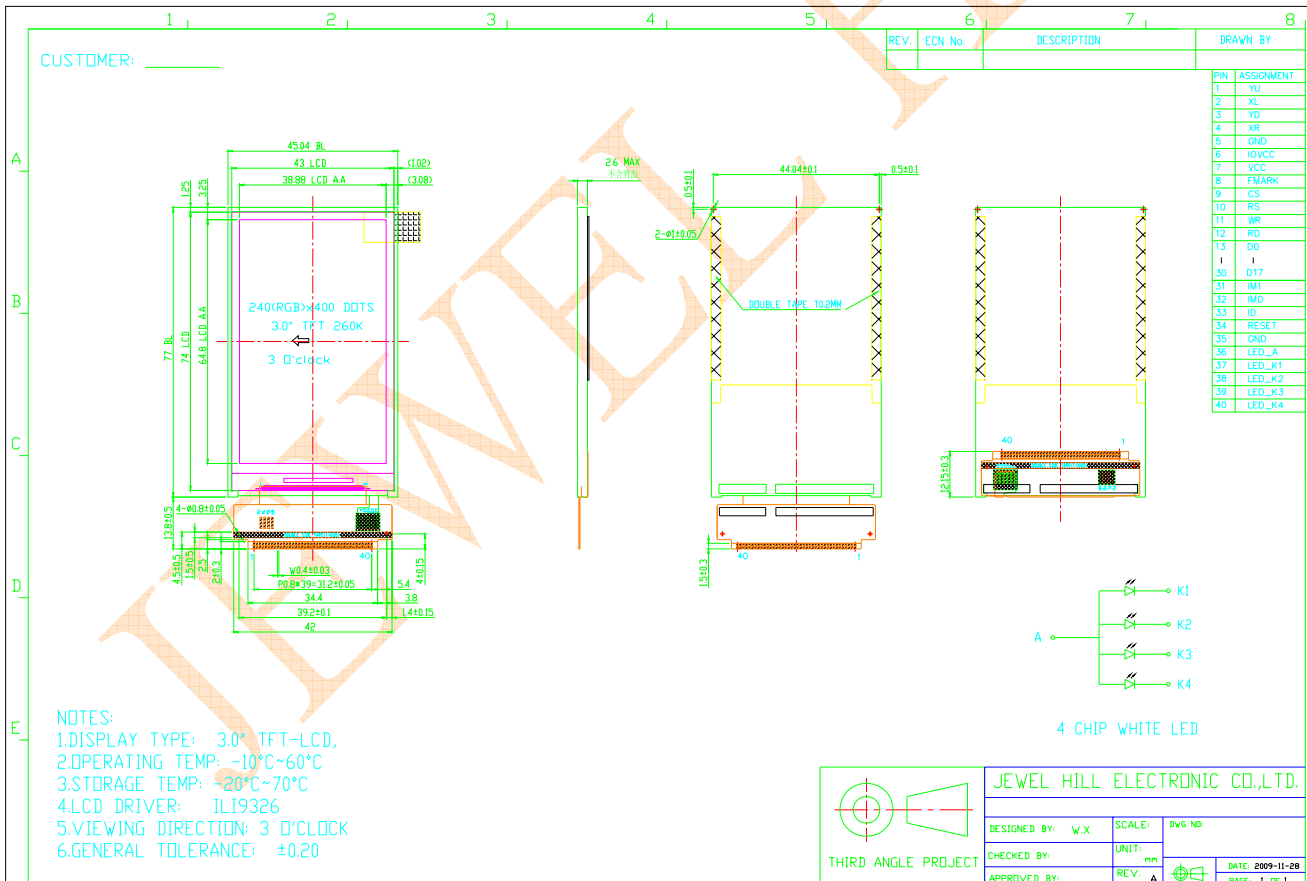

3.ABSOLUTE MAXIMUM RATINGS.

| Parameter | Symbol | Min | Max | Unit |
|--------------------------|------------------------------------|------|------------------------|------|
| Supply voltage for logic | IOV _{CC} /V _{CC} | -0.3 | 4.6 | V |
| Input voltage | V _{IN} | -0.3 | IOV _{CC} +0.3 | V |
| Operating temperature | T _{OP} | -10 | 60 | °C |
| Storage temperature | T _{ST} | -20 | 70 | °C |
| Humidity | RH | | 90%(Max60°C) | RH |

4.ELECTRICAL CHARACTERISTICS.

(V_{CC} = 2.40 ~ 3.30V, IOV_{CC} = 1.65 ~ 3.30V, Ta= -40 ~ 85 °C)

| Item | Symbol | Unit | Test Condition | Min. | Typ. | Max. | Note |
|--|------------------|------|--|-----------------------|---------------------------|-----------------------|------|
| Input high voltage | V _{IH} | V | V _{CC} = 1.8 ~ 3.3V | 0.8*IOV _{CC} | - | IOV _{CC} | - |
| Input low voltage | V _{IL} | V | V _{CC} = 1.8 ~ 3.3V | -0.3 | - | 0.2*IOV _{CC} | - |
| Output high voltage(1) (DB0-17 Pins) | V _{OHI} | V | IOH = -0.1 mA | 0.8*IOV _{CC} | - | - | - |
| Output low voltage (DB0-17 Pins) | V _{OL1} | V | IOV _{CC} =1.65~3.3V V _{CC} = 2.4 ~ 3.3V IOL = 0.1mA | - | - | 0.2*IOV _{CC} | - |
| I/O leakage current | I _{LI} | μA | V _{in} = 0 ~ V _{CC} | -0.1 | - | 0.1 | - |
| Current consumption during normal operation (V _{CC} - GND) | I _{OP} | μA | V _{CC} =2.8V , Ta=25°C , fOSC = 512KHz (Line) GRAM data = 0000h | - | 100 (V _{CC}) | - | - |
| Current consumption during standby mode (V _{CC} - GND) | I _{ST} | μA | V _{CC} =2.8V , Ta=25 °C | - | 5 | 10 | - |
| LCD Drive Power Supply Current (DDVDH-GND) | ILCD | mA | V _{CC} =2.8V , VREG1OUT =4.8V DDVDH=5.0V , fOSC = 512KHz (320 line) , Ta=25 °C , GRAM data = 0000h, REV="0", SAP="001", ON4-0="0", OP4-0="0", MP52-00="0", MN52-00="0", CP12-00="0" CN12-00="0" | - | 3.0 | - | - |
| LCD Driving Voltage (DDVDH-GND) | DDVDH | V | - | 4.5 | - | 6 | - |
| Output voltage deviation | | mV | - | - | 5 | - | - |
| Dispersion of the Average Output Voltage | V | mV | - | -10 | - | 10 | - |

5.SYSTEM INTERFACE

i80/18-bit System Interface

The i80/18-bit system interface is selected by setting the IM[2:0] as "000" levels.

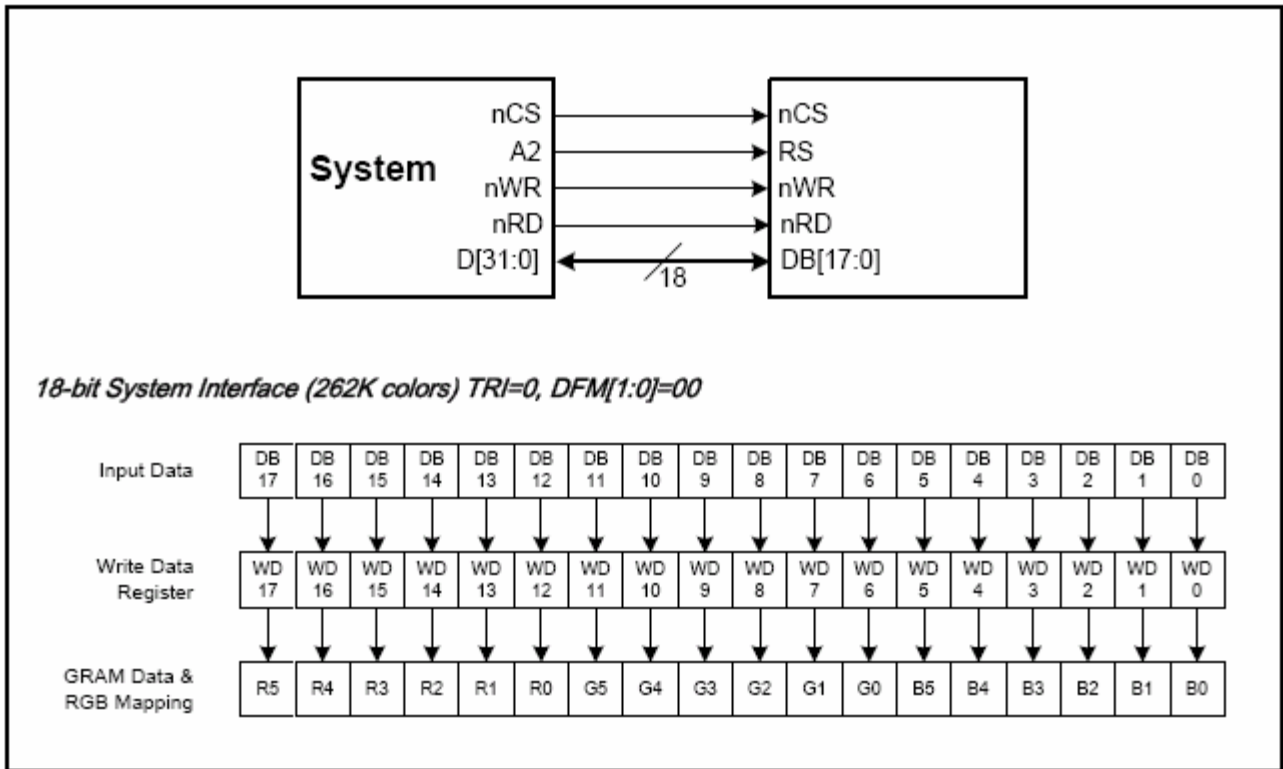

Figure2 18-bit System Interface Data Format

i80/16-bit System Interface

The i80/16-bit system interface is selected by setting the IM[2:0] as "010" levels. The 262K or 65K color can be display through the 16-bit MPU interface. When the 262K color is displayed, two transfers (1st transfer: 2 bits, 2nd transfer: 16 bits or 1st transfer: 16 bits, 2nd transfer: 2 bits) are necessary for the 16-bit CPU interface.

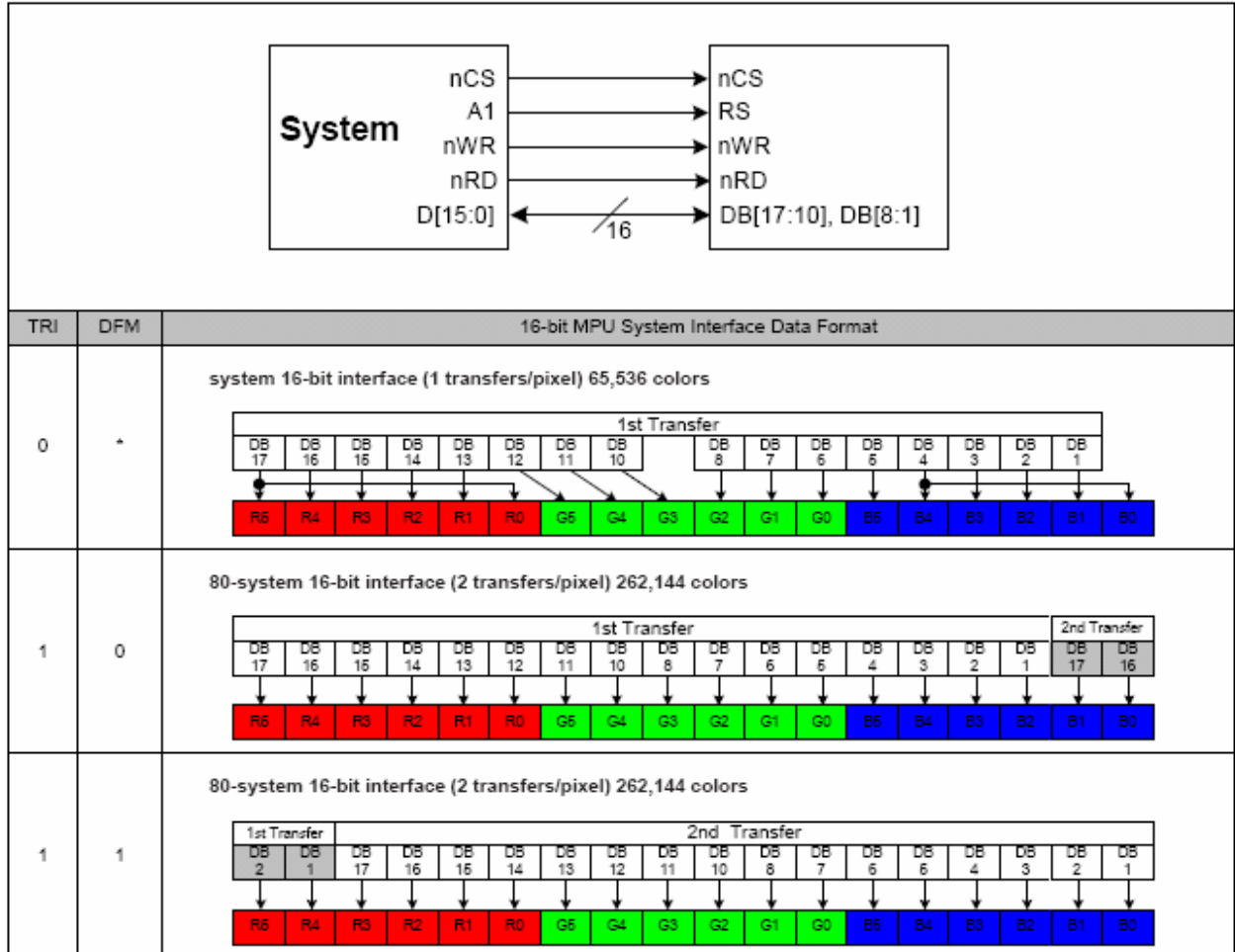
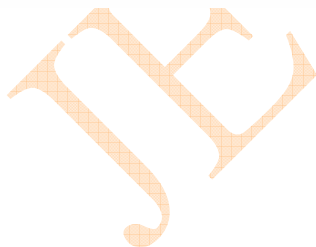

Figure3 16-bit System Interface Data Format



i80/9-bit System Interface

The i80/9-bit system interface is selected by setting the IM[2:0] as "001" and the DB17~DB9 pins are used to transfer the data. When writing the 16-bit register, the data is divided into upper byte (8 bits and LSB is not used) lower byte and the upper byte is transferred first. The display data is also divided in upper byte (9 bits) and lower byte, and the upper byte is transferred first. The unused DB[8:0] pins must be tied to either Vcc or AGND.

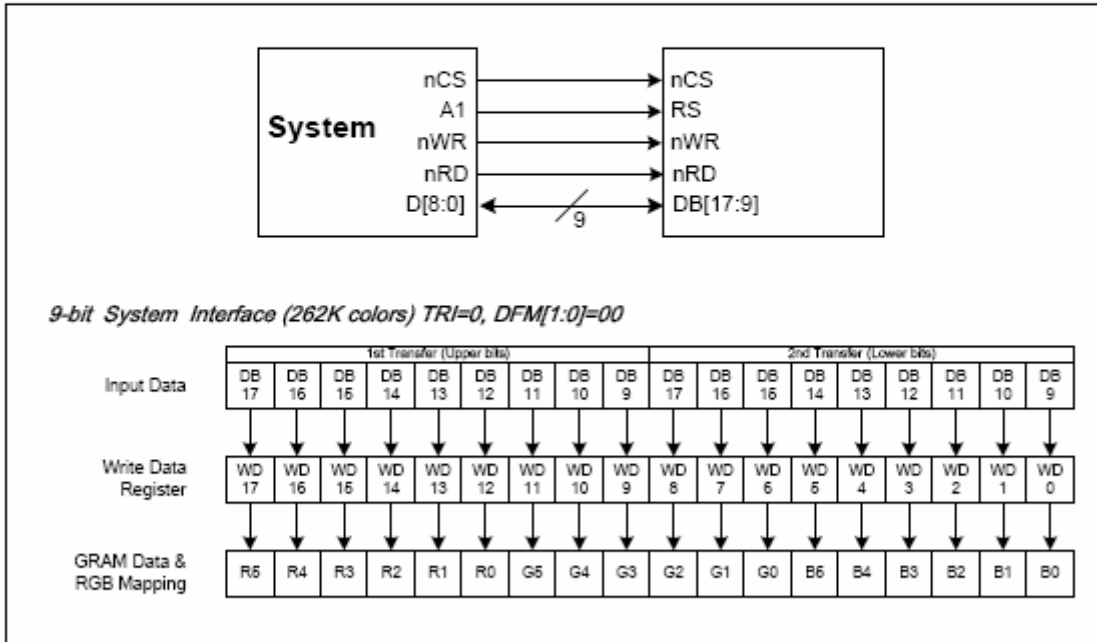

Figure4 9-bit System Interface Data Format

i80/8-bit System Interface

The i80/8-bit system interface is selected by setting the IM[2:0] as "011" and the DB17~DB10 pins are used to transfer the data. When writing the 16-bit register, the data is divided into upper byte (8 bits and LSB is not used) lower byte and the upper byte is transferred first. The display data is also divided in upper byte (8 bits) and lower byte, and the upper byte is transferred first. The written data is expanded into 18 bits internally (see the figure below) and then written into GRAM. The unused DB[9:0] pins must be tied to either Vcc or AGND.

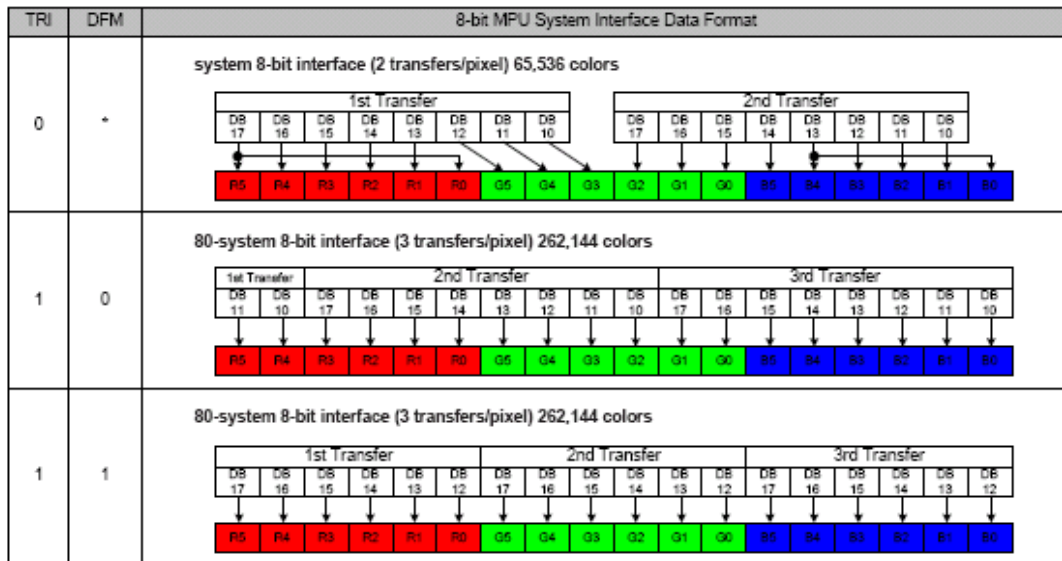

Figure5 8-bit System Interface Data Format

Data transfer synchronization in 8/9-bit bus interface mode

ILI9326 supports a data transfer synchronization function to reset upper and lower counters which count the transfers numbers of upper and lower byte in 8/9-bit interface mode. If a mismatch arises in the numbers of transfers between the upper and lower byte counters due to noise and so on, the "00'h register is written 4 times consecutively to reset the upper and lower counters so that data transfer will restart with a transfer of upper byte. This synchronization function can effectively prevent display error if the upper/lower counters are periodically reset.

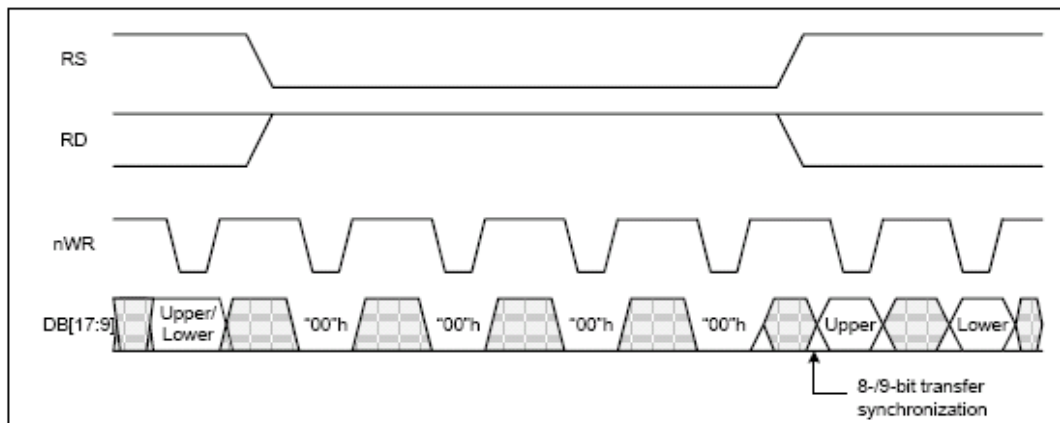

Figure6 Data Transfer Synchronization in 8/9-bit System Interface

6.BACKLIGHT CHARACTERISTICS.

| Item | Symbol | Min. | Typ. | Max. | Unit | Condition |
|-----------------|--------|----------|------|------|-------------------|-----------|
| Forward voltage | Vf | 3.0 | 3.2 | 3.4 | V | If=60mA |
| Luminance | Lv | 2800 | 3200 | 3600 | cd/m ² | Ta=25°C |
| Number of LED | - | 4 | | | Piece | - |
| Connection mode | P | Parallel | | | - | - |

ELECTEO-OPTICAL CHARACTERISTICS

| Item | Symbol | Condition | Min | Typ | Max | Unit | Remark | Note |
|-------------------------|-------------------|--|-------|-------|-------|-------------------|--------|------|
| Response time | Tr+ Tf | $\theta=0^\circ$ $\varnothing=0^\circ$ Ta=25°C | --- | 23 | 34.5 | ms | FIG 1. | 4 |
| Contrast ratio | Cr | | 400 | 800 | --- | --- | FIG 2. | 1 |
| Luminance uniformity | δ WHITE | | 80 | 89 | --- | % | FIG 2. | 3 |
| Surface Luminance | Lv | | 224 | 280 | --- | cd/m ² | FIG 2. | 2 |
| Viewing angle range | θ | $\varnothing = 90^\circ$ | 70 | 80 | --- | deg | FIG 3. | 6 |
| | | $\varnothing = 270^\circ$ | 70 | 80 | --- | deg | FIG 3. | |
| | | $\varnothing = 0^\circ$ | 70 | 80 | --- | deg | FIG 3. | |
| | | $\varnothing = 180^\circ$ | 70 | 80 | --- | deg | FIG 3. | |
| CIE (x, y) chromaticity | Red | x | 0.550 | 0.600 | 0.650 | --- | FIG 4. | 5 |
| | | y | 0.294 | 0.344 | 0.394 | | | |
| | Green | x | 0.282 | 0.332 | 0.382 | | | |
| | | y | 0.544 | 0.594 | 0.644 | | | |
| | Blue | x | 0.097 | 0.147 | 0.197 | | | |
| | | y | 0.021 | 0.071 | 0.121 | | | |
| | White | x | 0.241 | 0.301 | 0.361 | | | |
| | | y | 0.262 | 0.322 | 0.382 | | | |

Note 1. Contrast Ratio(CR) is defined mathematically as For more information see FIG 2.:

$$\text{Contrast Ratio} = \frac{\text{Average Surface Luminance with all white pixels (P 1,P2, P 3,P4, P5)}}{\text{Average Surface Luminance with all black pixels (P1, P2, P 3,P4, P5)}}$$

Note 2. Surface luminance is the LCD surface from the surface with all pixels displaying white. For more information see FIG 2.

$$L_v = \text{Average Surface Luminance with all white pixels (P1, P2, P 3,P4, P5)}$$

Note 3. The uniformity in surface luminance, δ WHITE is determined by measuring luminance at each test position 1 through 5, and then dividing the maximum luminance of 5 points luminance by minimum luminance of 5 points luminance. For more information see FIG 2.

$$\delta \text{ WHITE} = \frac{\text{Minimum Surface Luminance with all white pixels (P1, P2, P 3,P4, P5)}}{\text{Maximum Surface Luminance with all white pixels (P1, P2, P 3,P4, P5)}}$$

Note 4. Response time is the time required for the display to transition from White to black(Rise Time, Tr) and from black to white(Decay Time, Tf). For additional information see FIG 1. The test equipment is Autronic-Melchers's ConoScope. Series

Note 5. CIE (x, y) chromaticity, The x,y value is determined by measuring luminance at each test position 1 through 5, and then make average value

Note 6. Viewing angle is the angle at which the contrast ratio is greater than 2. For TFT module the contrast ratio is greater than 10. The angles are determined for the horizontal or x axis and the vertical or y axis with respect to the z axis which is normal to the LCD surface. For more information see FIG 3.

Note7. For Viewing angle and response time testing, the testing data is base on Autronic-Melchers's ConoScope. Series Instruments. For contrast ratio, Surface Luminance, Luminance uniformity, CIE The test data is base on TOPCON's BM-5 photo detector.

FIG.1 The definition of Response Time

The response time is defined as the following figure and shall be measured by switching the input signal for "black" and "white".

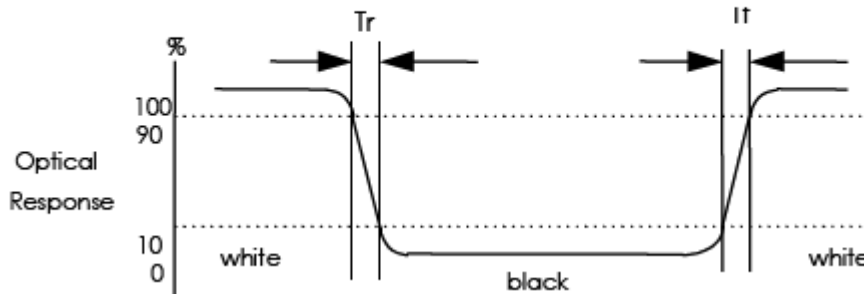

FIG.2 Measuring method for contrast ratio, surface luminance, luminance uniformity, CIE(x,y) Chromaticity

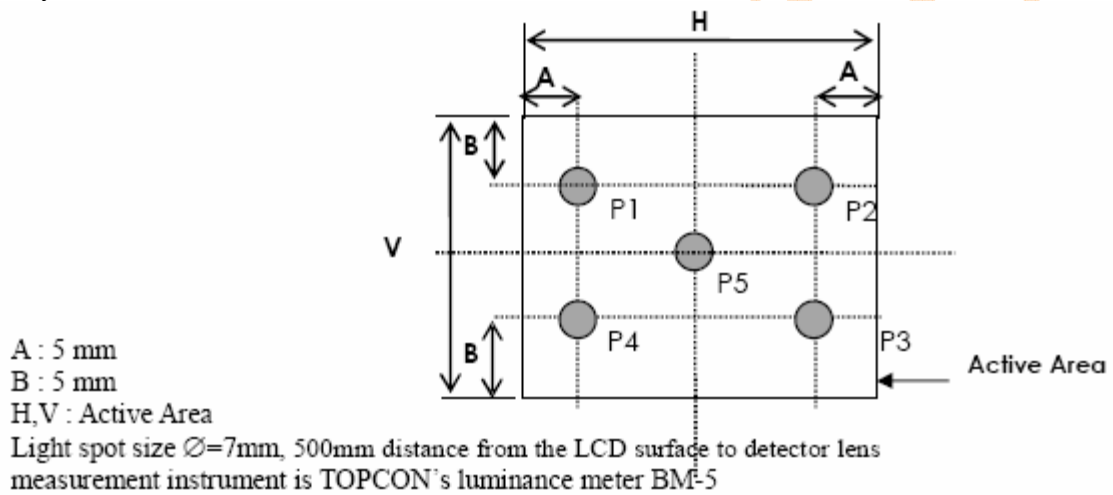
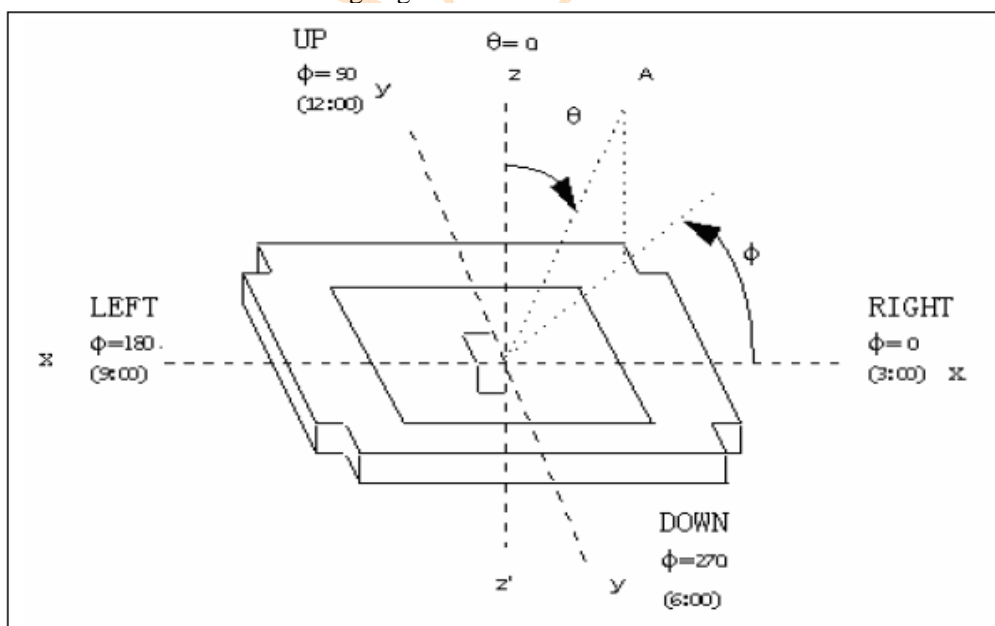

FIG.3 The definition of viewing angle



7.INTERFACE DESCRIPTION.

| Pin No. | Symbol | Level | Description | When not in use | | | | | | | | | | | | | | | | | | | | | | | | | | | | | | | | | | | | | | | | |
|--|----------|-----------|--|------------------------------------|----------------|--------------------|--------|--------|---|---|----------------------------|--------|---------|---|---|---------------------------|--------|---------|---|---|----------------------------|----------------|--------------------|---|---|---------------------------|---------|--------------------|---|-------|------------------------------------|---|--------|---|---|------------------|---|---|---|---|------------------|---|---|---|
| 1 | Y(U) | - | Touch panel coordinate in the up side of envisage drawing. | - | | | | | | | | | | | | | | | | | | | | | | | | | | | | | | | | | | | | | | | | |
| 2 | X(L) | - | Touch panel coordinate in the left side of envisage drawing. | - | | | | | | | | | | | | | | | | | | | | | | | | | | | | | | | | | | | | | | | | |
| 3 | Y(D) | - | Touch panel coordinate in the down side of envisage drawing. | - | | | | | | | | | | | | | | | | | | | | | | | | | | | | | | | | | | | | | | | | |
| 4 | X(R) | - | Touch panel coordinate in the right side of envisage drawing. | - | | | | | | | | | | | | | | | | | | | | | | | | | | | | | | | | | | | | | | | | |
| 5 | GND | VSS | Ground. | - | | | | | | | | | | | | | | | | | | | | | | | | | | | | | | | | | | | | | | | | |
| 6 | IOVCC | 1.65~3.1V | Power supply to the interface pins. | - | | | | | | | | | | | | | | | | | | | | | | | | | | | | | | | | | | | | | | | | |
| 7 | VCC | 2.5~3.1V | Power supply to internal logic regulator circuit. | - | | | | | | | | | | | | | | | | | | | | | | | | | | | | | | | | | | | | | | | | |
| 8 | FMARK | H/L | Frame head pulse signal. | Open | | | | | | | | | | | | | | | | | | | | | | | | | | | | | | | | | | | | | | | | |
| 9 | CS | H/L | Chip select signal. | GND or IOVCC | | | | | | | | | | | | | | | | | | | | | | | | | | | | | | | | | | | | | | | | |
| 10 | RS | H/L | Register select signal. | GND or IOVCC | | | | | | | | | | | | | | | | | | | | | | | | | | | | | | | | | | | | | | | | |
| 11 | WR | H/L | Write signal. | GND or IOVCC | | | | | | | | | | | | | | | | | | | | | | | | | | | | | | | | | | | | | | | | |
| 12 | RD | H/L | Read signal. | GND or IOVCC | | | | | | | | | | | | | | | | | | | | | | | | | | | | | | | | | | | | | | | | |
| 13~30 | DB0~DB17 | H/L | Data bus. | GND or IOVCC | | | | | | | | | | | | | | | | | | | | | | | | | | | | | | | | | | | | | | | | |
| 31 | IM1 | H/L | Select a mode to interface to an MPU. In serial interface operation, the IM0 pin is used to set the ID bit of device code. <table border="1" data-bbox="587 1093 1220 1592"> <thead> <tr> <th>IM1</th> <th>IM0/ID</th> <th>Interface Mode</th> <th>DB Pin</th> <th>Colors</th> </tr> </thead> <tbody> <tr> <td>0</td> <td>0</td> <td>80-system 18-bit interface</td> <td>DB17-0</td> <td>262,144</td> </tr> <tr> <td>0</td> <td>1</td> <td>80-system 9-bit interface</td> <td>DB17-9</td> <td>262,144</td> </tr> <tr> <td>1</td> <td>0</td> <td>80-system 16-bit interface</td> <td>DB17-10, DB8-1</td> <td>262,144 see Note 1</td> </tr> <tr> <td>1</td> <td>1</td> <td>80-system 8-bit interface</td> <td>DB17-10</td> <td>262,144 see Note 2</td> </tr> <tr> <td>0</td> <td>*(ID)</td> <td>Clock synchronous serial interface</td> <td>-</td> <td>65,536</td> </tr> <tr> <td>1</td> <td>0</td> <td>Setting disabled</td> <td>-</td> <td>-</td> </tr> <tr> <td>1</td> <td>1</td> <td>Setting disabled</td> <td>-</td> <td>-</td> </tr> </tbody> </table> | IM1 | IM0/ID | Interface Mode | DB Pin | Colors | 0 | 0 | 80-system 18-bit interface | DB17-0 | 262,144 | 0 | 1 | 80-system 9-bit interface | DB17-9 | 262,144 | 1 | 0 | 80-system 16-bit interface | DB17-10, DB8-1 | 262,144 see Note 1 | 1 | 1 | 80-system 8-bit interface | DB17-10 | 262,144 see Note 2 | 0 | *(ID) | Clock synchronous serial interface | - | 65,536 | 1 | 0 | Setting disabled | - | - | 1 | 1 | Setting disabled | - | - | - |
| IM1 | IM0/ID | | | Interface Mode | DB Pin | Colors | | | | | | | | | | | | | | | | | | | | | | | | | | | | | | | | | | | | | | |
| 0 | 0 | | | 80-system 18-bit interface | DB17-0 | 262,144 | | | | | | | | | | | | | | | | | | | | | | | | | | | | | | | | | | | | | | |
| 0 | 1 | | | 80-system 9-bit interface | DB17-9 | 262,144 | | | | | | | | | | | | | | | | | | | | | | | | | | | | | | | | | | | | | | |
| 1 | 0 | | | 80-system 16-bit interface | DB17-10, DB8-1 | 262,144 see Note 1 | | | | | | | | | | | | | | | | | | | | | | | | | | | | | | | | | | | | | | |
| 1 | 1 | | | 80-system 8-bit interface | DB17-10 | 262,144 see Note 2 | | | | | | | | | | | | | | | | | | | | | | | | | | | | | | | | | | | | | | |
| 0 | *(ID) | | | Clock synchronous serial interface | - | 65,536 | | | | | | | | | | | | | | | | | | | | | | | | | | | | | | | | | | | | | | |
| 1 | 0 | | | Setting disabled | - | - | | | | | | | | | | | | | | | | | | | | | | | | | | | | | | | | | | | | | | |
| 1 | 1 | | | Setting disabled | - | - | | | | | | | | | | | | | | | | | | | | | | | | | | | | | | | | | | | | | | |
| 32 | IM0 | | | | | | | | | | | | | | | | | | | | | | | | | | | | | | | | | | | | | | | | | | | |
| 33 | ID | | | | | | | | | | | | | | | | | | | | | | | | | | | | | | | | | | | | | | | | | | | |
| Notes: 1. 65,536 colors in one transfer mode 2. 65,536 colors in two transfers mode | | | | | | | | | | | | | | | | | | | | | | | | | | | | | | | | | | | | | | | | | | | | |
| 34 | RESET | H/L | Reset signal pin. | - | | | | | | | | | | | | | | | | | | | | | | | | | | | | | | | | | | | | | | | | |
| 35 | GND | 0V | Ground. | - | | | | | | | | | | | | | | | | | | | | | | | | | | | | | | | | | | | | | | | | |
| 36 | A | - | LED, anode. | - | | | | | | | | | | | | | | | | | | | | | | | | | | | | | | | | | | | | | | | | |
| 37~40 | K1~K4 | - | LED, cathode. | - | | | | | | | | | | | | | | | | | | | | | | | | | | | | | | | | | | | | | | | | |

CN2

| Pin No. | Symbol | Level | Description | When not in use |
|---------|--------|-------|---|-----------------|
| 1 | Y(U) | - | Touch panel coordinate in the up side of envisage drawing. | - |
| 2 | X(L) | - | Touch panel coordinate in the left side of envisage drawing. | - |
| 3 | Y(D) | - | Touch panel coordinate in the down side of envisage drawing. | - |
| 4 | X(R) | - | Touch panel coordinate in the right side of envisage drawing. | - |

8.RELIABILITY TEST.

| No. | Test Item | Test Condition | Inspection after test |
|-----|----------------------------|---|--|
| 1 | High Temperature Storage | 80±2℃/200 hours | Inspection after 2~4 hours storage at room temperature , the sample shall be free from defects: 1. Air bubble in the LCD; 2. Sealleak; 3.Non-display; 4.missing segments; 5.Glass crack; 6.Current Idd is twice higher than initial value. |
| 2 | Low Temperature Storage | -30±2℃/200 hours | |
| 3 | High Temperature Operating | 70±2℃/120 hours | |
| 4 | Low Temperature Operating | -20±2℃/120 hours | |
| 5 | Temperature Cycle | -20 ± 2 ℃ ~25~70 ± 2 ℃ × 10cycles (30min.) (5min.) (30min.) | |
| 6 | Damp Proof Test | 50℃±5℃×90%RH/120 hours | |
| 7 | Vibration Test | Frequency: 10Hz~55Hz~10Hz Amplitude: 1.5mm, X, Y, Z direction for total 3hours (Packing condition) | |
| 8 | Drooping test | Drop to the ground from 1m height, one time, every side of carton. (Packing condition) | |
| 9 | ESD test | Voltage: ± 8KV R: 330 Ω C: 150pF Air discharge, 10time | |

Remark:

- 1.The test samples should be applied to only one test item.
- 2.Sample size for each test item is 5~10pcs.
- 3.For Damp Proof Test, Pure water(Resistance>10MΩ) should be used.
- 4.In case of malfunction defect caused by ESD damage, if it would be recovered to normal state after resetting, it would be judge as a good part.
- 5.EL evaluation should be excepted from reliability test with humidity and temperature: Some defects such as black spot/blemish can happen by natural chemical reaction with humidity and Fluorescence EL has.
- 6.Please use automatic switch menu(or roll menu) testing mode when test operating mode.

9.INSPECTION CRITERION.

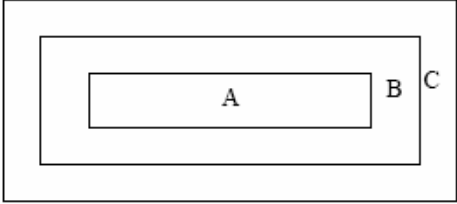
| | |
|---|-------------|
| OUTGOING QUALITY STANDARD | PAGE 1 OF 7 |
| TITLE:FUNCTIONAL TEST & INSPECTION CRITERIA | MDS Product |
| <p>This specification is made to be used as the standard acceptance/rejection criteria for Color mobile phone LCM with touch pannel.</p> <p>1 Sample plan</p> <p>Sampling plan according to GB/T2828.1-2003/ISO 2859-1: 1999 and ANSI/ASQC Z1.4-1993, normal level 2 and based on:</p> <p style="padding-left: 40px;">Major defect: AQL 0.65</p> <p style="padding-left: 40px;">Minor defect: AQL 1.5</p> <p>2. Inspection condition</p> <p>Viewing distance for cosmetic inspection is about 30cm with bare eyes, and under an environment of 20~40W light intensity, all directions for inspecting the sample should be within 45° against perpendicular line.</p> <p>3. Definition of inspection zone in LCD.</p> <div style="text-align: center; margin: 20px 0;">  </div> <p>Zone A: character/Digit area Zone B: viewing area except Zone A (ZoneA+ZoneB=minimum Viewing area) Zone C: Outside viewing area (invisible area after assembly in customer's product)</p> <p>Fig.1 Inspection zones in an LCD.</p> <p>Note: As a general rule, visual defects in Zone C are permissible, when it is no trouble for quality and assembly of customer's product.</p> | |

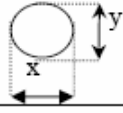
| OUTGOING QUALITY STANDARD | | PAGE 2 OF 7 | | | | | | | | | | | | | | | | | | | | | | | | |
|---|---|--|---------------------------|----------------|--|---|---|---|-----------------|-----------------|--------|--|-------------------------|-------------------------|---|--|-------------------------|-------------------------|---|--|---------------|---------------|---|--|-------|-------|
| TITLE:FUNCTIONAL TEST & INSPECTION CRITERIA | | MDS Product | | | | | | | | | | | | | | | | | | | | | | | | |
| 4. Inspection standards | | | | | | | | | | | | | | | | | | | | | | | | | | |
| 4.1 Major Defect | | | | | | | | | | | | | | | | | | | | | | | | | | |
| Item No | Items to be inspected | Inspection Standard | Classification of defects | | | | | | | | | | | | | | | | | | | | | | | |
| 4.1.1 | All functional defects | 1) No display 2) Display abnormally 3) Missing vertical, horizontal segment 4) Short circuit 5) Back-light no lighting, flickering and abnormal lighting. | Major | | | | | | | | | | | | | | | | | | | | | | | |
| 4.1.2 | Missing | Missing component | | | | | | | | | | | | | | | | | | | | | | | | |
| 4.1.3 | Outline dimension | Overall outline dimension beyond the drawing is not allowed. | | | | | | | | | | | | | | | | | | | | | | | | |
| 4.1.4 | linearity | No more than 1.5% | | | | | | | | | | | | | | | | | | | | | | | | |
| 4.2 Cosmetic Defect | | | | | | | | | | | | | | | | | | | | | | | | | | |
| Item No | Items to be inspected | Inspection Standard | Classification of defects | | | | | | | | | | | | | | | | | | | | | | | |
| 4.2.1 | Clear Spots Black and white Spot defect Pinhole, Foreign Particle, polarizer Dirt | For dark/white spot, size Φ is defined as $\Phi = \frac{(x+y)}{2}$  1. <table border="1" style="margin-left: 20px;"> <thead> <tr> <th rowspan="2">Zone Size(mm)</th> <th colspan="3">Acceptable Qty</th> </tr> <tr> <th>A</th> <th>B</th> <th>C</th> </tr> </thead> <tbody> <tr> <td>$\Phi \leq 0.1$</td> <td colspan="3">Ignore</td> </tr> <tr> <td>$0.10 < \Phi \leq 0.15$</td> <td colspan="3">2</td> </tr> <tr> <td>$0.15 < \Phi \leq 0.20$</td> <td colspan="3">1</td> </tr> <tr> <td>$0.20 < \Phi$</td> <td colspan="3">0</td> </tr> </tbody> </table> | Zone Size(mm) | Acceptable Qty | | | A | B | C | $\Phi \leq 0.1$ | Ignore | | | $0.10 < \Phi \leq 0.15$ | 2 | | | $0.15 < \Phi \leq 0.20$ | 1 | | | $0.20 < \Phi$ | 0 | | | Minor |
| | Zone Size(mm) | Acceptable Qty | | | | | | | | | | | | | | | | | | | | | | | | |
| A | | B | C | | | | | | | | | | | | | | | | | | | | | | | |
| $\Phi \leq 0.1$ | Ignore | | | | | | | | | | | | | | | | | | | | | | | | | |
| $0.10 < \Phi \leq 0.15$ | 2 | | | | | | | | | | | | | | | | | | | | | | | | | |
| $0.15 < \Phi \leq 0.20$ | 1 | | | | | | | | | | | | | | | | | | | | | | | | | |
| $0.20 < \Phi$ | 0 | | | | | | | | | | | | | | | | | | | | | | | | | |
| Clear Spots TP Dirt | 2. <table border="1" style="margin-left: 20px;"> <thead> <tr> <th rowspan="2">Zone Size(mm)</th> <th colspan="3">Acceptable Qty</th> </tr> <tr> <th>A</th> <th>B</th> <th>C</th> </tr> </thead> <tbody> <tr> <td>$\Phi \leq 0.1$</td> <td colspan="3">Ignore</td> </tr> <tr> <td>$0.10 < \Phi \leq 0.15$</td> <td colspan="3">3</td> </tr> <tr> <td>$0.15 < \Phi \leq 0.25$</td> <td colspan="3">2</td> </tr> <tr> <td>$0.25 < \Phi$</td> <td colspan="3">0</td> </tr> </tbody> </table> | Zone Size(mm) | Acceptable Qty | | | A | B | C | $\Phi \leq 0.1$ | Ignore | | | $0.10 < \Phi \leq 0.15$ | 3 | | | $0.15 < \Phi \leq 0.25$ | 2 | | | $0.25 < \Phi$ | 0 | | | Minor | |
| Zone Size(mm) | Acceptable Qty | | | | | | | | | | | | | | | | | | | | | | | | | |
| | A | B | C | | | | | | | | | | | | | | | | | | | | | | | |
| $\Phi \leq 0.1$ | Ignore | | | | | | | | | | | | | | | | | | | | | | | | | |
| $0.10 < \Phi \leq 0.15$ | 3 | | | | | | | | | | | | | | | | | | | | | | | | | |
| $0.15 < \Phi \leq 0.25$ | 2 | | | | | | | | | | | | | | | | | | | | | | | | | |
| $0.25 < \Phi$ | 0 | | | | | | | | | | | | | | | | | | | | | | | | | |

| OUTGOING QUALITY STANDARD | | | | PAGE 3 OF 7 | | | | | | | | | | | | | | | | | | | | | | | | | | |
|--|---|--|-----------------------|----------------|---------------------|---------------------------|--|--|---|---|---|-----------------|--------|--|--|-------------------------|---|--|--|-------------------------|---|--|--|---------------|---|--|--|-------|--|--|
| TITLE: FUNCTIONAL TEST & INSPECTION CRITERIA | | | | MDS Product | | | | | | | | | | | | | | | | | | | | | | | | | | |
| | Dim Spots Circle shaped and dim edged defects | 3. <table border="1"> <thead> <tr> <th rowspan="2">2. Zone Size(mm)</th> <th colspan="3">Acceptable Qty</th> </tr> <tr> <th>A</th> <th>B</th> <th>C</th> </tr> </thead> <tbody> <tr> <td>$\Phi \leq 0.2$</td> <td colspan="3">Ignore</td> </tr> <tr> <td>$0.20 < \Phi \leq 0.40$</td> <td colspan="3">2</td> </tr> <tr> <td>$0.40 < \Phi \leq 0.60$</td> <td colspan="3">1</td> </tr> <tr> <td>$0.60 < \Phi$</td> <td colspan="3">0</td> </tr> </tbody> </table> | | | 2. Zone Size(mm) | Acceptable Qty | | | A | B | C | $\Phi \leq 0.2$ | Ignore | | | $0.20 < \Phi \leq 0.40$ | 2 | | | $0.40 < \Phi \leq 0.60$ | 1 | | | $0.60 < \Phi$ | 0 | | | Minor | | |
| 2. Zone Size(mm) | Acceptable Qty | | | | | | | | | | | | | | | | | | | | | | | | | | | | | |
| | A | B | C | | | | | | | | | | | | | | | | | | | | | | | | | | | |
| $\Phi \leq 0.2$ | Ignore | | | | | | | | | | | | | | | | | | | | | | | | | | | | | |
| $0.20 < \Phi \leq 0.40$ | 2 | | | | | | | | | | | | | | | | | | | | | | | | | | | | | |
| $0.40 < \Phi \leq 0.60$ | 1 | | | | | | | | | | | | | | | | | | | | | | | | | | | | | |
| $0.60 < \Phi$ | 0 | | | | | | | | | | | | | | | | | | | | | | | | | | | | | |
| 4.2 Cosmetic Defect | | | | | | | | | | | | | | | | | | | | | | | | | | | | | | |
| Item No | Items to be inspected | Inspection Standard | | | | Classification of defects | | | | | | | | | | | | | | | | | | | | | | | | |
| 4.2.2 | Line defect Black line, White line, Foreign material on polarizer | size(mm) | | Acceptable Qty | | | | | | | | | | | | | | | | | | | | | | | | | | |
| | | L(Length) | W(Width) | zone | | | | | | | | | | | | | | | | | | | | | | | | | | |
| | | | | A | B | C | | | | | | | | | | | | | | | | | | | | | | | | |
| | | Ignore | $W \leq 0.02$ | Ignore | | | | | | | | | | | | | | | | | | | | | | | | | | |
| | | $L \leq 3.0$ | $0.02 < W \leq 0.03$ | 2 | | | | | | | | | | | | | | | | | | | | | | | | | | |
| | | $L \leq 2.0$ | $0.03 < W \leq 0.05$ | 1 | | | | | | | | | | | | | | | | | | | | | | | | | | |
| | | $0.05 < W$ | Define as spot defect | | | | | | | | | | | | | | | | | | | | | | | | | | | |
| | Foreign material on TP film | The line can be seen after mobile phone in the operating condition: | | | | | | | | | | | | | | | | | | | | | | | | | | | | |
| | | size(mm) | | Acceptable Qty | | | | | | | | | | | | | | | | | | | | | | | | | | |
| | | L(Length) | W(Width) | zone | | | | | | | | | | | | | | | | | | | | | | | | | | |
| | | | A | B | C | | | | | | | | | | | | | | | | | | | | | | | | | |
| Ignore | | $W \leq 0.03$ | Ignore | | | | | | | | | | | | | | | | | | | | | | | | | | | |
| | $L \leq 5.0$ | $0.03 < W \leq 0.05$ | 3 | | | | | | | | | | | | | | | | | | | | | | | | | | | |
| | | $0.05 < W$ | Define as spot defect | | | | | | | | | | | | | | | | | | | | | | | | | | | |
| | | If the scratch can be seen after mobile phone cover assembling or in the operating condition, judge by the line defect of 4.2.2. If the scratch can be seen only in non-operating condition or some special angle, judge by the following. | | | | | | | | | | | | | | | | | | | | | | | | | | | | |

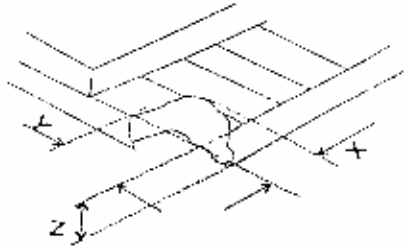
| OUTGOING QUALITY STANDARD | | | | PAGE 4 OF 7 | | | | | | | | |
|---|---|---|----------------------|----------------|--------|---------------------------|-------|---|------------|----------|-----------|-------|
| TITLE:FUNCTIONAL TEST & INSPECTION CRITERIA | | | | MDS Product | | | | | | | | |
| 4.2.3 | Dim line defect Polarizer scratch TP film scratch | Size(mm) | | Acceptable Qty | | | Minor | | | | | |
| | | L(Length) | W(Width) | Zone | | | | | | | | |
| | | | | A | B | C | | | | | | |
| | | Ignore | $W \leq 0.03$ | Ignore | | Ignore | | | | | | |
| | | $5.0 < L \leq 10.0$ | $0.03 < W \leq 0.05$ | 2 | | | | | | | | |
| | | $L \leq 5.0$ | $0.05 < W \leq 0.08$ | 1 | | | | | | | | |
| | $0.08 < W$ | 0 | | | | | | | | | | |
| 4.2.4 | Polarize Air bubble | Air bubbles between glass & polarizer | | | | | Minor | | | | | |
| | | 2. Zone Size(mm) | Acceptable Qty | | | | | | | | | |
| | | | A | B | C | | | | | | | |
| | | $\Phi \leq 0.2$ | Ignore | | Ignore | | | | | | | |
| | | $0.20 < \Phi \leq 0.30$ | 2 | | | | | | | | | |
| | | $0.30 < \Phi \leq 0.50$ | 1 | | | | | | | | | |
| $0.50 < \Phi$ | 0 | | | | | | | | | | | |
| 4.3. Cosmetic Defect | | | | | | | | | | | | |
| Item No | Items to be inspected | Inspection Standard | | | | Classification of defects | | | | | | |
| | | (i) Chips on corner A:LCD Glass defect  <table border="1" data-bbox="571 1751 1177 1848"> <tr> <td>X</td> <td>Y</td> <td>Z</td> </tr> <tr> <td>≤ 2.0</td> <td>$\leq S$</td> <td>Disregard</td> </tr> </table> <p>Notes: S=contact pad length Chips on the corner of terminal shall not be allowed to extend into the ITO pad or expose perimeter seal.</p> | | | | X | Y | Z | ≤ 2.0 | $\leq S$ | Disregard | Minor |
| X | Y | Z | | | | | | | | | | |
| ≤ 2.0 | $\leq S$ | Disregard | | | | | | | | | | |

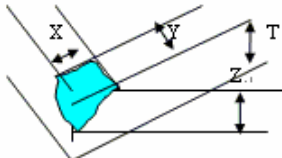
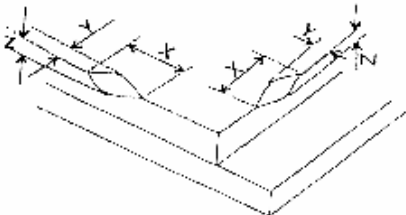
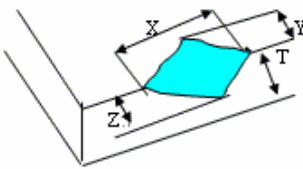
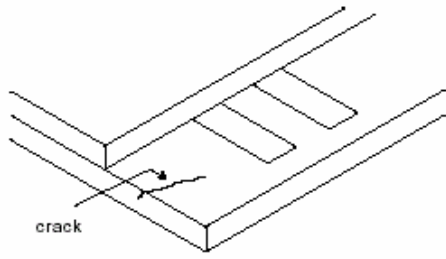



| OUTGOING QUALITY STANDARD | | PAGE 5 OF 7 | | | | | | | | | | | |
|--|--------------------------------|--|-------|-----------|--------------------------------|-----------|-------|-----------|-------|------|------|-----------|-------|
| TITLE:FUNCTIONAL TEST & INSPECTION CRITERIA | | MDS Product | | | | | | | | | | | |
| 4.3.5 | Glass defect | <p>B:TP Glass defect</p>  <table border="1"> <thead> <tr> <th>X(mm)</th> <th>Y(mm)</th> <th>Z(mm)</th> </tr> </thead> <tbody> <tr> <td>≤3.0</td> <td>≤3.0</td> <td>Disregard</td> </tr> </tbody> </table> | X(mm) | Y(mm) | Z(mm) | ≤3.0 | ≤3.0 | Disregard | | | | | |
| | | X(mm) | Y(mm) | Z(mm) | | | | | | | | | |
| | | ≤3.0 | ≤3.0 | Disregard | | | | | | | | | |
| <p>(ii) Usual surface cracks</p> <p>A:LCD Glass defect</p>  <table border="1"> <thead> <tr> <th>X</th> <th>Y</th> <th>Z</th> </tr> </thead> <tbody> <tr> <td>≤3.0</td> <td><Inner border line of the seal</td> <td>Disregard</td> </tr> </tbody> </table> <p>B:TP Glass defect</p>  <table border="1"> <thead> <tr> <th>X(mm)</th> <th>Y(mm)</th> <th>Z(mm)</th> </tr> </thead> <tbody> <tr> <td>≤6.0</td> <td><2.0</td> <td>Disregard</td> </tr> </tbody> </table> | X | Y | Z | ≤3.0 | <Inner border line of the seal | Disregard | X(mm) | Y(mm) | Z(mm) | ≤6.0 | <2.0 | Disregard | Minor |
| X | Y | Z | | | | | | | | | | | |
| ≤3.0 | <Inner border line of the seal | Disregard | | | | | | | | | | | |
| X(mm) | Y(mm) | Z(mm) | | | | | | | | | | | |
| ≤6.0 | <2.0 | Disregard | | | | | | | | | | | |
| <p>(iii) Crack</p> <p>Cracks tend to break are not allowed.</p>  | Major | | | | | | | | | | | | |

| | |
|---------------------------|-------------|
| OUTGOING QUALITY STANDARD | PAGE 6 OF 7 |
|---------------------------|-------------|

| | |
|---|-------------|
| TITLE:FUNCTIONAL TEST & INSPECTION CRITERIA | MDS Product |
|---|-------------|

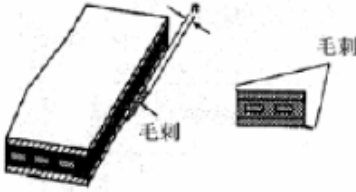
4.4 Parts Defect

| Item No | Items to be inspected | Inspection Standard | Classification of defects |
|---------|----------------------------|---|---------------------------|
| | 4.4.1 Parts contraposition | 1、 Not allow IC and FPC/heat-seal lead width is more than 50% beyond lead pattern. 2、 Not allow chip or solder component is off center more than 50% of the pad outline. | Major |
| | 4.4.2 SMT | According to the <Acceptability of electronic assemblies> IPC-A-610C class 2 standard. Component missing or function defect are Major defect, the others are Minor defect. | |

| OUTGOING QUALITY STANDARD | | PAGE 7 OF 7 | |
|--|----------------------------|---|--------------|
| TITLE: FUNCTIONAL TEST & INSPECTION CRITERIA | | MDS Product | |
| | <p>4.4.3 TP Defect</p> | <p>1、 Pattern font: Pattern fonts are clear and symmetrical, pattern fonts filter lightly are allowed; The font line is not allow to thinner or thicker than 1/3of normal size, and swing is not more than 0.1mm. the line is smooth and not broken.</p>  <p>图案字体 Pattern font</p> <p>2、 The wing forward in the side of Visual Area: The length of wing forward inside of the Visual Area: $n \leq 0.2\text{mm}$; Not excess 3 point, and the distance $D \geq 20\text{mm}$.</p>  <p>3、 Film impression: With operation, must be invisibility.</p> <p>4、 Touch panel knob: if writing function normally, it could be allowed.</p>  <p>TP鼓 TP knob</p> <p>5、 Newton ring Without operation, the color circle of Regularity or Non-regularity from the normal or slope angle of view.</p> <p>1、 Regularity: The area of the newton ring is less than 1/3 area of the touch panel; and no character affected and line distorted after touch panel lightening. It's ok.</p> <p>2、 Non-regularity : The area of the Newton ring is less than the 1/2 area of touch panel with lightening. And no character affected and line</p>  <p>规律形</p>  <p>非规律形</p> | <p>Minor</p> |

10.PRECAUTIONS FOR USING LCD MODULES.

Handling Precautions

(1) The display panel is made of glass and polarizer. As glass is fragile. It tends to become or chipped during handling especially on the edges. Please avoid dropping or jarring. Do not subject it to a mechanical shock by dropping it or impact.

(2) If the display panel is damaged and the liquid crystal substance leaks out, be sure not to get any in your mouth. If the substance contacts your skin or clothes, wash it off using soap and water.

(3) Do not apply excessive force to the display surface or the adjoining areas since this may cause the color tone to vary. Do not touch the display with bare hands. This will stain the display area and degraded insulation between terminals (some cosmetics are determined to the polarizer).

(4) The polarizer covering the display surface of the LCD module is soft and easily scratched. Handle this polarizer carefully. Do not touch, push or rub the exposed polarizers with anything harder than an HB pencil lead (glass, tweezers, etc.). Do not put or attach anything on the display area to avoid leaving marks on. Condensation on the surface and contact with terminals due to cold will damage, stain or dirty the polarizer. After products are tested at low temperature they must be warmed up in a container before coming is contacting with room temperature air.

(5) If the display surface becomes contaminated, breathe on the surface and gently wipe it with a soft dry cloth. If it is heavily contaminated, moisten cloth with one of the following solvents

- Isopropyl alcohol
- Ethyl alcohol

Do not scrub hard to avoid damaging the display surface.

(6) Solvents other than those above-mentioned may damage the polarizer. Especially, do not use the following.

- Water
- Ketone
- Aromatic solvents

Wipe off saliva or water drops immediately, contact with water over a long period of time may cause deformation or color fading. Avoid contacting oil and fats.

(7) Exercise care to minimize corrosion of the electrode. Corrosion of the electrodes is accelerated by water droplets, moisture condensation or a current flow in a high-humidity environment.

(8) Install the LCD Module by using the mounting holes. When mounting the LCD module make sure it is free of twisting, warping and distortion. In particular, do not forcibly pull or bend the I/O cable or the backlight cable.

(9) Do not attempt to disassemble or process the LCD module.

(10) NC terminal should be open. Do not connect anything.

(11) If the logic circuit power is off, do not apply the input signals.

(12) Electro-Static Discharge Control, Since this module uses a CMOS LSI, the same careful attention should be paid to electrostatic discharge as for an ordinary CMOS IC. To prevent destruction of the elements by static electricity, be careful to maintain an optimum work environment.

- Before remove LCM from its packing case or incorporating it into a set, be sure the module and your body have the same electric potential. Be sure to ground the body when handling the LCD modules.

- Tools required for assembling, such as soldering irons, must be properly grounded. make certain the AC power source for the soldering iron does not leak. When using an electric screwdriver to attach LCM, the screwdriver should be of ground potentiality to minimize as much as possible any transmission of electromagnetic waves produced sparks coming from the commutator of the motor.

- To reduce the amount of static electricity generated, do not conduct assembling and other work under dry conditions. To reduce the generation of static electricity be careful that the air in the work is not too dried. A relative humidity of 50%-60% is recommended. As far as possible make the electric potential of your work clothes and that of the work bench the ground potential

- The LCD module is coated with a film to protect the display surface. Exercise care when peeling off this protective film since static electricity may be generated

(13) Since LCM has been assembled and adjusted with a high degree of precision, avoid applying excessive shocks to the module or making any alterations or modifications to it.

- Do not alter, modify or change the shape of the tab on the metal frame.
- Do not make extra holes on the printed circuit board, modify its shape or change the position of components to be attached.
- Do not damage or modify the pattern writing on the printed circuit board.
- Absolutely do not modify the zebra rubber strip (conductive rubber) or heat seal connector.
- Except for soldering the interface, do not make any alterations or modifications with a soldering iron.
- Do not drop, bend or twist LCM.

Handling precaution for LCM

LCM is easy to be damaged.
Please note below and be careful for handling!

Correct handling:



As above picture, please handle with anti-static gloves around LCM edges.

Incorrect handling:

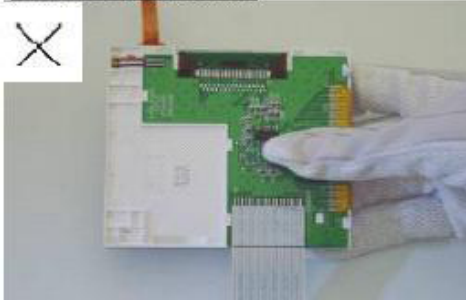

Please don't touch IC directly.

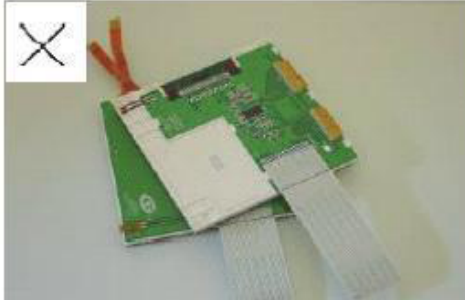

Please don't stack LCM.

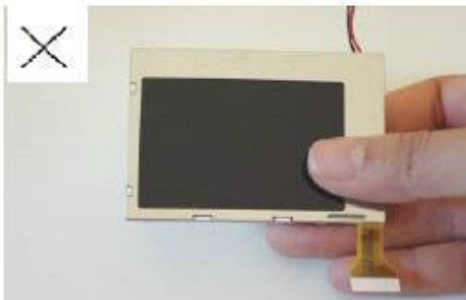

Please don't hold the surface of panel.

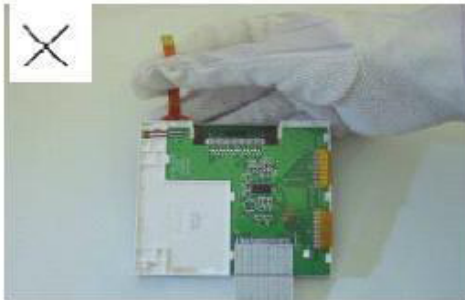

Please don't stretch interface of output, such as FPC cable.

Handling precaution for LCD

LCD is easy to be damaged.
Please note below and be careful for handling!

Correct handling:

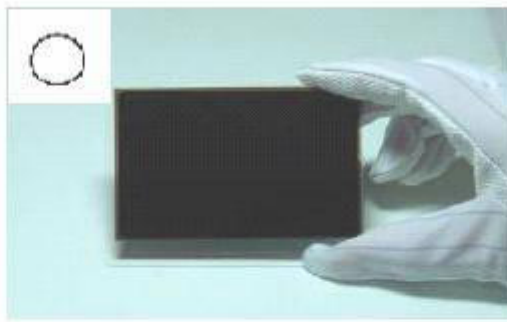

As above photo, please handle with anti-static gloves around LCD edges.

Incorrect handling:



Please don't stack the LCDS.



Please don't hold the surface of LCD.



Please don't operate with sharp stick such as pens.

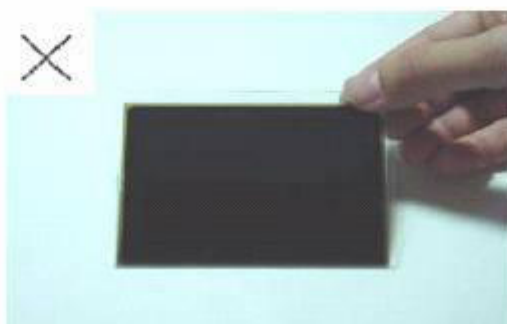

Please don't touch ITO glass without anti-static gloves.

Handling precaution for Touch panel

Touch Panel is easy to be damaged.
Please note below and be careful for handling!

Correct handling:

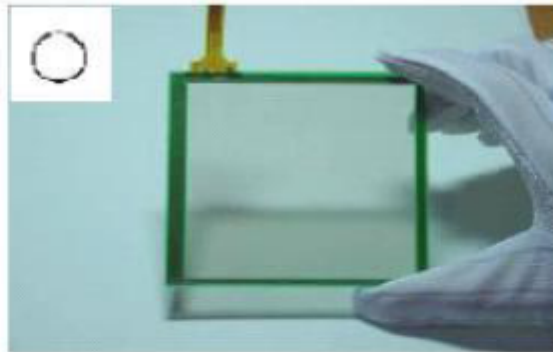
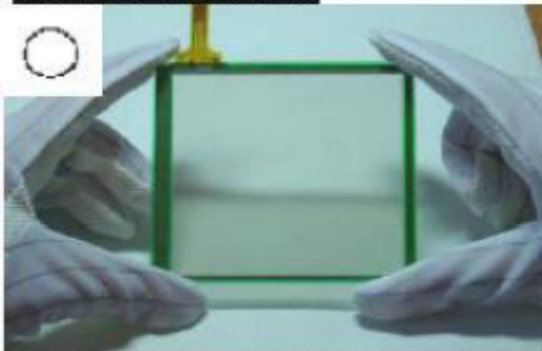

As above picture, please handle with anti-static gloves around touch panel edges.

Incorrect handling:



Please don't operate with sharp stick such as pencil.

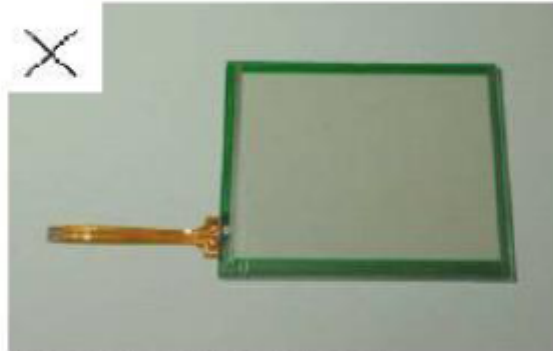

Please keep film surface on upper side.

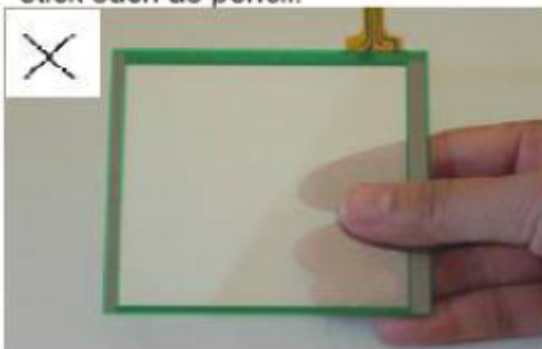

Please don't hold the surface of touch panel.

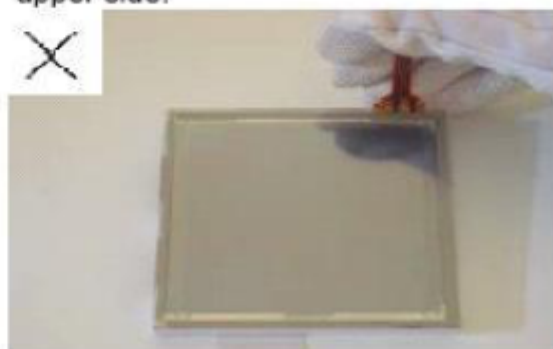

Please don't hold FPC, stretch FPC, or twist FPC.

Storage Precautions

When storing the LCD modules, the following precaution is necessary.

- (1) Store them in a sealed polyethylene bag. If properly sealed, there is no need for the dessicant.
- (2) Store them in a dark place. Do not expose to sunlight or fluorescent light, keep the temperature between 0°C and 35°C, and keep the relative humidity between 40%RH and 60%RH.
- (3) The polarizer surface should not come in contact with any other objects. (We advise you to store them in the anti-static electricity container in which they were shipped.

Others

Liquid crystals solidify under low temperature (below the storage temperature range) leading to defective orientation or the generation of air bubbles (black or white). Air bubbles may also be generated if the module is subject to a low temperature.

If the LCD modules have been operating for a long time showing the same display patterns, the display patterns may remain on the screen as ghost images and a slight contrast irregularity may also appear. A normal operating status can be regained by suspending use for some time. It should be noted that this phenomenon does not adversely affect performance reliability.

To minimize the performance degradation of the LCD modules resulting from destruction caused by static electricity etc., exercise care to avoid holding the following sections when handling the modules.

- Exposed area of the printed circuit board.
- Terminal electrode sections.

■ USING LCD MODULES

Installing LCD Modules

The hole in the printed circuit board is used to fix LCM as shown in the picture below. Attend to the following items when installing the LCM.

- (1) Cover the surface with a transparent protective plate to protect the polarizer and LC cell.

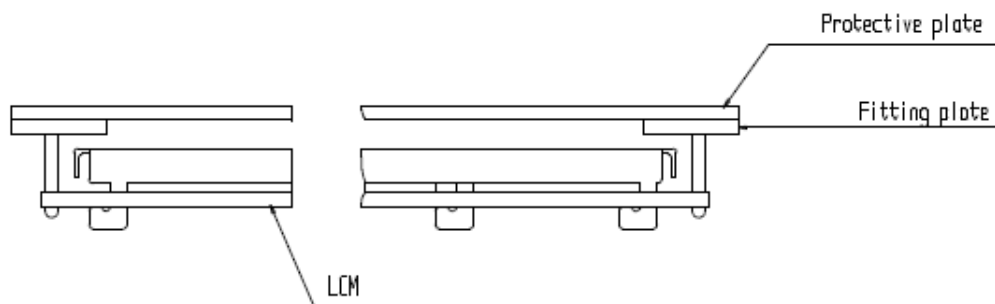

- (2) When assembling the LCM into other equipment, the spacer to the bit between the LCM and the fitting plate should have enough height to avoid causing stress to the module surface, refer to the individual specifications for measurements. The measurement tolerance should be ± 0.1 mm.

Precaution for assemble the module with BTB connector:

Please note the position of the male and female connector position, don't assemble or assemble like the method which the following picture shows



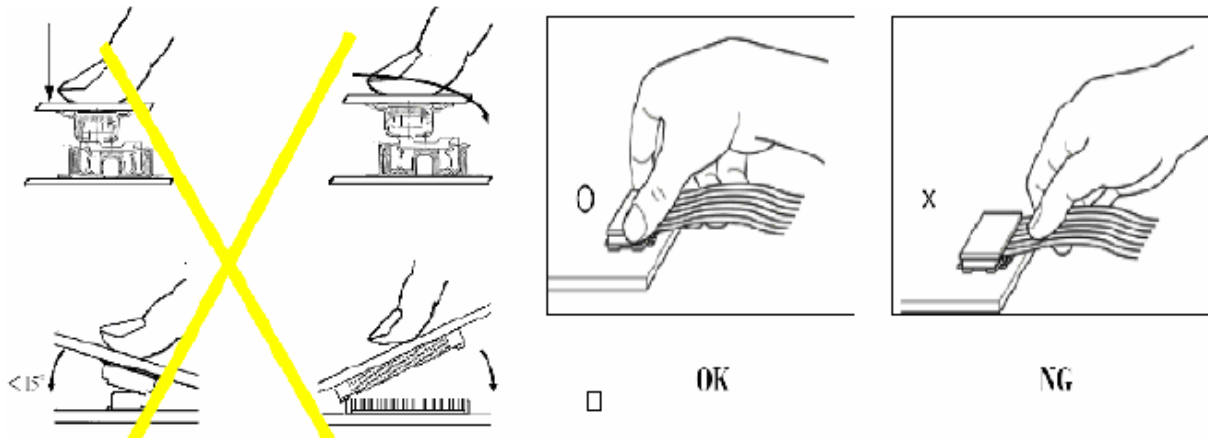

Precaution for soldering the LCM

| | Manual soldering | Machine drag soldering | Machine press soldering |
|-----------------|-------------------------------|------------------------------------|--|
| No ROHS product | 290°C ~350°C. Time : 3-5S. | 330°C ~350°C. Speed : 4-8 mm/s. | 300°C ~330°C. Time : 3-6S. Press: 0.8~1.2Mpa |
| ROHS product | 340°C ~370°C. Time : 3-5S. | 350°C ~370°C. Time : 4-8 mm/s. | 330°C ~360°C. Time : 3-6S. Press: 0.8~1.2Mpa |

(1) If soldering flux is used, be sure to remove any remaining flux after finishing to soldering operation. (This does not apply in the case of a non-halogen type of flux.) It is recommended that you protect the LCD surface with a cover during soldering to prevent any damage due to flux spatters.

(2) When soldering the electroluminescent panel and PC board, the panel and board should not be detached more than three times. This maximum number is determined by the temperature and time conditions mentioned above, though there may be some variance depending on the temperature of the soldering iron.

(3) When remove the electroluminescent panel from the PC board, be sure the solder has completely melted, the soldered pad on the PC board could be damaged.

Precautions for Operation

(1) Viewing angle varies with the change of liquid crystal driving voltage (VLCD). Adjust VLCD to show the best contrast.

(2) It is an indispensable condition to drive LCD's within the specified voltage limit since the higher voltage then the limit cause the shorter LCD life. An electrochemical reaction due to direct current causes LCD's undesirable deterioration, so that the use of direct current drive should be avoided.

(3) Response time will be extremely delayed at lower temperature than the operating temperature range and on the other hand at higher temperature LCD's show dark color in them. However those phenomena do not mean malfunction or out of order with LCD's, Which will come back in the specified operating temperature.

(4) If the display area is pushed hard during operation, the display will become abnormal. However, it will return to normal if it is turned off and then back on.

(5) A slight dew depositing on terminals is a cause for electro-chemical reaction resulting in terminal open circuit. Usage under the maximum operating temperature, 50%RH or less is required.

(6) Input each signal after the positive/negative voltage becomes stable.

(7) Please keep the temperature within specified range for use and storage. Polarization degradation, bubble generation or polarizer peel-off may occur with high temperature and high humidity.

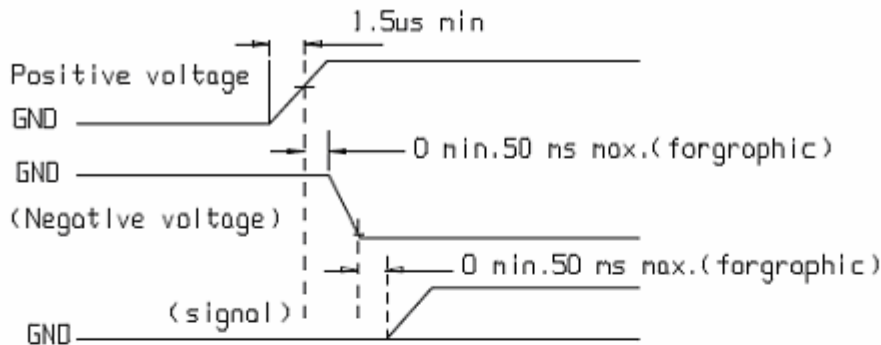

Safety

- (1) It is recommended to crush damaged or unnecessary LCDs into pieces and wash them off with solvents such as acetone and ethanol, which should later be burned.
- (2) If any liquid leaks out of a damaged glass cell and comes in contact with the hands, wash off thoroughly with soap and water.

Limited Warranty

Unless agreed between TRULY and customer, TRULY will replace or repair any of its LCD modules which are found to be functionally defective when inspected in accordance with TRULY LCD acceptance standards (copies available upon request) for a period of one year from date of shipments. Cosmetic/visual defects must be returned to TRULY within 90 days of shipment. Confirmation of such date shall be based on freight documents. The warranty liability of TRULY limited to repair and/or replacement on the terms set forth above. TRULY will not be responsible for any subsequent or consequential events.

Return LCM under warranty

No warranty can be granted if the precautions stated above have been disregarded. The typical examples of violations are :

- Broken LCD glass.
- PCB eyelet is damaged or modified.
- PCB conductors damaged.
- Circuit modified in any way, including addition of components.
- PCB tampered with by grinding, engraving or painting varnish.
- Soldering to or modifying the bezel in any manner.

Module repairs will be invoiced to the customer upon mutual agreement. Modules must be returned with sufficient description of the failures or defects. Any connectors or cable installed by the customer must be removed completely without damaging the PCB eyelet, conductors and terminals.

11. PACKING SPECIFICATION.

TBD



12. REVISION HISTORY

| Version | Revise record | Date |
|---------|---|----------|
| 1.0 | Original version | 09-11-28 |
| 1.1 | Perfect the VER1.0 spec, Commany internal modify. | 13-08-01 |
| | | |
| | | |
| | | |
| | | |
| | | |
| | | |
| | | |
| | | |
| | | |
| | | |
| | | |
| | | |
| | | |
| | | |
| | | |
| | | |
| | | |
| | | |

JEWEL HILL



SAMPLE APPROVED REPORT
(样品确认单)

| | |
|---|---------------|
| SAMPLE MODEL NO. (样品型号) | JH30240400D |
| SAMPLE SERIES NUMBER NO. (样品序号) | |
| SAMPLE QUANTITY (样品数量) | |
| COLOR/TYPE (底色/类型) | TFT/NEGATIVE |
| VIEWING DIRECTION (视角) | 3H |
| DRIVING METHOD (驱动参数) | 1/400DUTY |
| LOGIC VOLTAGE (工作电压) | 2.8V |
| LCD VOP (LCD 驱动电压) | |
| OPERATING TEMP. (操作温度) °C | -10~60°C |
| STORAGE TEMP. (储存温度) °C | -20~70°C |
| POLARIZER----FRONT (首偏光片) | TRANSMISSIVE |
| POLARIZER----BACK (后偏光片) | |
| CONTROLLER/DRIVER IC(控制/驱动 IC) | ILI9326 (COG) |
| BACKLIGHT COLOR/TYPE (背光源类型/颜色) | LED/WHITE |
| DRAWING REV/NO./QUANTITY (图纸版本/数量) | - |
| SPECIFICATION (规格书 份数) | 1BATE |
| REMARKS: (备注) | |
| WRIT BY: _____ DATE: _____ APROV BY: _____ DATE: _____ | |
| CUSTOMER'S APPROVAL (客户确认): | |
| 1) FUNCTION (功能): <input type="checkbox"/> OK <input type="checkbox"/> N.G. | |
| 2) DRIVER CONDITION (驱动条件): <input type="checkbox"/> OK <input type="checkbox"/> N.G. | |
| 3) DISPLAY MODE (显示模式): <input type="checkbox"/> OK <input type="checkbox"/> N.G. | |
| 4) VIEWING ANGLE (视角): <input type="checkbox"/> OK <input type="checkbox"/> N.G. | |
| 5) BACKLIGHT (背光源): <input type="checkbox"/> OK <input type="checkbox"/> N.G. | |
| 6) DISPLAYING PATTERN (显示效果): <input type="checkbox"/> OK <input type="checkbox"/> N.G. | |
| CUSTOMER'S CONCLUSIONS (客户意见): _____ | |
| _____ | |
| _____ | |
| CUSTOMER'S SIGNATURE (客户签名): _____ DATE (日期): _____ | |