



NTC Thermistors

QUALITY POLICY

品質政策

QUALITY RELIABLE & STABLE

CUSTOMER SECURE & DELIGHTFUL

品質穩定 客戶安心

CONTENTS

目錄

Characteristics and function introduction 特性與功能介紹	01-05
Ordering code 料號系統	06
Dimension of components 尺寸規格	07
S series specification S 系列規格	08-17
Taping specification 編帶規格	18
Marking & packaging 打印及包裝	19
JD series specification JD系列規格	20
JF series specification JF 系列規格	21
JT series specification JT 系列規格	22
JS series specification JS 系列規格	23
R/T Table R/T 對照表格	24
JSR series specification JSR系列規格	25-27
Assembly series specification 組合系列規格	28

NTC THERMISTOR-INRUSH CURRENT LIMITING DEVICES

Joyin NTC Thermistor(JNR) devices are made of a specially formulated metal oxide ceramic material which is capable of suppressing high inrush current surges.

JNR devices, being of relatively high resistance, shall limit the inrush current for 1 ~ 2 seconds during which time the device decreased in resistance substantially to a point where its voltage drop is negligible. The devices are especially useful in power supplies (see FigA) because of the extremely low impedance of the capacitor being charged, of which the bridge is usually subjected to an exceedingly high current surge at turn-on point.

FEATURES

- High inrush current restriction effect.
- Small power loss in stationary state.
(Normally 1W or less than 50W power.)
- High thermal and electrical stability.
- Wide selection of electrical characteristics.

APPLICATION

As shown in Fig. B, the current surge can be eliminated by placing a NTC thermistor in series with a filament string. Yet, if the resistance of one NTC thermistor does not provide sufficient inrush current limiting functions for your application, two or more may be used in series or in separate legs of the supply circuit(Fig. A). Be noticed, the thermistor can not be used in parallel since one unit will tend to conduct nearly all the current available. Thus, JNR thermistor may be used in the AC(point A1 or A2) or the DC(point D1 or D2) locations in the circuit.(See Fig. A)

The resistance of NTC thermistor is designed higher than the total resistance of filaments when the circuit is turned on.

As current begins flowing, the thermistor shall immediately "self-heat". Then, in 1 ~ 2 seconds, its resistance will be reduced to a minimum and become insignificant to the total resistance of a circuit. With the same concept, current surges in electric motors can be held to minimum. Fig. C shows a typical DC motor's turn on surge before and after the application of a JNR thermistor to the circuit.

NTC熱敏電阻-突流限制元件

久尹的NTC熱敏電阻器(定名為JNR)係由特殊配製的金屬氧化物陶瓷材料製成,它可用來抑制高的突波電流。相對於受保護電路,JNR熱敏電阻器具有較高的電阻;因此會抑制突波電流約1~2秒,在這一段時間內JNR的電阻將因溫度升高而下降,直至熱敏電阻兩端壓降到可被忽略的電阻值為止。如圖A以電源供應器為例,在電源開的瞬間,電容器一般阻抗極低,橋式整流器通常承受很大的電流,故JNR熱敏電阻器特別適用於保護電源供應器。

特質

- 有效抑制突波電流。
- 穩定狀態下功率損耗極小(通常僅有1W或小於50W)。
- 熱及電特性穩定性高。
- 寬廣的電性規格可供選擇。

應用概述

如圖B所示,將一NTC熱敏電阻與一白熱燈絲串聯時,可以消除突波電流。若一只NTC熱敏電阻無法提供足夠之突流限制功能時,二只或更多的熱敏電阻可用於串聯電路上或供應電路的各個分路上(如圖A)。但要注意的是NTC熱敏電阻,不可並聯於電路上,因為其中一只NTC就可能會傳導幾乎所有的電流。JNR熱敏電阻最好用於圖A所示AC電路的A1或A2處,或是DC電路D1或D2處。在設計上,當電路剛被打開的瞬間,NTC熱敏電阻的阻值高於電路上所有白熱燈絲的總電阻值。當電流開始通過時,熱敏電阻隨即產生「自熱」現象,並在1到2秒內,阻值會降到幾可忽略。以同樣的構想來看電動馬達的突波電流,亦可以被抑制到最低限度。圖C表示應用JNR熱敏電阻保護直流馬達前後突波電流波形的差異。

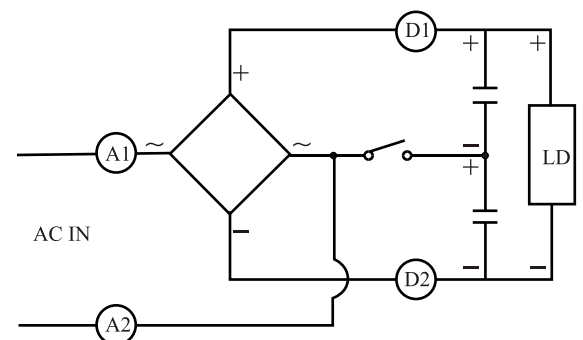

Fig.A

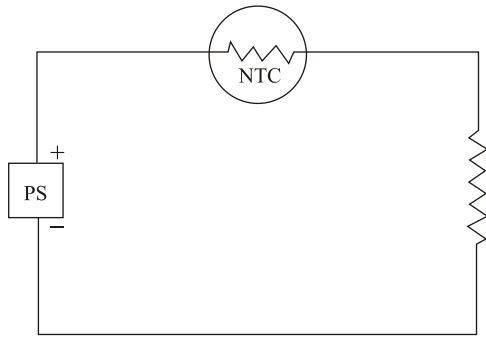

Fig.B

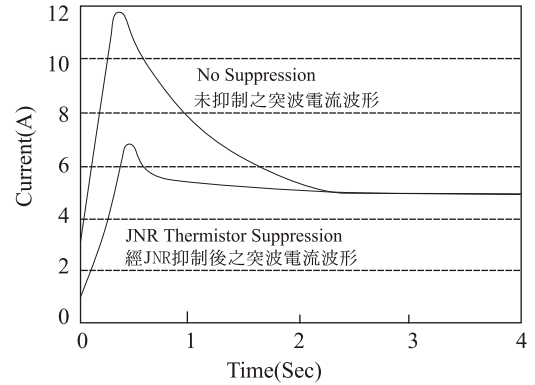

Fig.C

NTC THERMISTOR CHARACTERISTICS

To choose for application or take as referable parameters, the NTC thermistors are usually decided by the following three fundamental characteristics:

Temperature-Resistance Characteristic:

The resistance value of NTC thermistor is decreased while The ambient temperature or itself temperature is increased.

(See Fig.D)

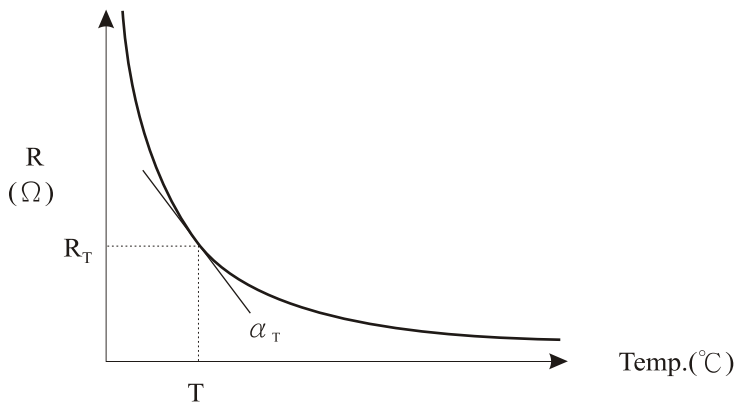

Fig.D

NTC熱敏電阻之特性

應用上NTC元件的參數,通常由下列三種基本特性決定:

溫度-電阻特性:

當NTC熱敏電阻之環境溫度或它本身的溫度上升時, NTC的電阻值隨之減小(如圖D)。

(如左圖D)

- Nominal resistance at 25°C(Ω) R_{25}
- Zero-power resistance(Ω) R_T
- Tolerance on the resistance nominal
 $\Delta R_{25}/R_{25}=15\%(L), 20\%(M)$
- Material constant(Sensibility index)(°K) β
- Temperature coefficient of resistance(% / °C) α_T

- 25°C時之電阻值(Ω) R_{25}
- 零功率電阻值(Ω) R_T
- 電阻值之容許差
 $\Delta R_{25}/R_{25}=15\%(L), 20\%(M)$
- 材料常數(敏感度指數)(°K) β
- 電阻溫度係數(% / °C) α_T

Voltage-Current Characteristic:

When operating in small current (see fig.E), due to very low power is unable to make the NTC thermistor self-heated, so its resistance value is thus maintained constant and displayed with a linear curve (in conformity with ohm-law $V/R=I$). if the current is increased, the NTC thermistor will follow Joule-efficiency($P=V \times I$) and make itself self-heated that results in a resistance value decreasing and thus displays with a status of "voltage descending while current increased."

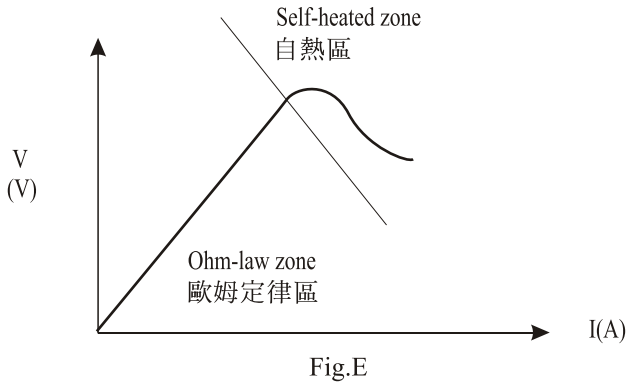

(如左圖E)

- Thermal dissipation coefficient($mW/^{\circ}C$) δ
- Maximum steady-state current(A) I_{max} .
- Resistance at maximum current(Ω) $R_{I_{max}}$.

電壓-電流特性:

當NTC熱敏電阻在小電流下工作時(如圖E),由於功率太低,其電阻值保持固定而表現線性關係(符合歐姆定律 $V/R=I$)。如果電流增加,NTC熱敏電阻就會產生焦耳效應($P=V \times I$)而使自己發熱,其電阻值隨即減小表現「電流增加,電壓下降」的狀態。

- 熱散逸係數($mW/^{\circ}C$) δ
- 最大穩定電流(A) I_{max} .
- 最大電流時之電阻(Ω) $R_{I_{max}}$.

Temperature-Time Characteristic:

As shown in Fig. F which explains the time needed to reach the thermal equilibrium of NTC components with the environment. This characteristic depends on two important parameters. If a step change in temperature is applied to a component e.g. from high(T_1) to low(T_0) temperature, the energy lost ($\delta (T-T_0)dt$) by the component($-HdT$)is equal to the energy dissipated by it. $-HdT = \delta (T-T_0)dt$
This equation yields: $T-T_1 = (T_0-T_1) \times e^{-t/\tau}$, $\tau = H/\delta$

溫度-時間特性:

(如圖F),說明NTC元件與環境達成熱平衡所需的時間,主要決定於材料熱容量(H)及散熱係數(δ)。當元件溫度由 T_1 降到 T_0 ,則可得到下列平衡式:
 $-HdT = \delta (T-T_0)dt$ 其中 $-HdT$ =元件熱損失
 $\delta (T-T_0)dt$:元件散熱量
積分後可得溫度與時間關係式 $T-T_1 = (T_0-T_1) \times e^{-t/\tau}$
其中 $\tau = H/\delta$

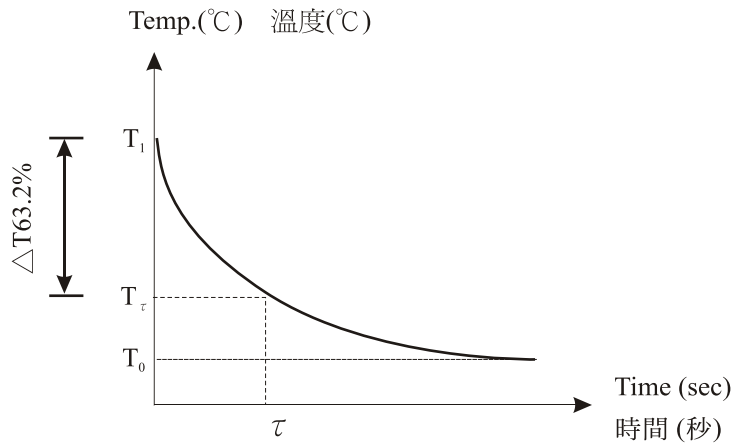

(如左圖F)



DERATING CURVE OF SURGE CURRENT LIMITING THERMISTOR

The maximum power of thermistor will decrease with the change of ambient temperature.

(See Fig.G)

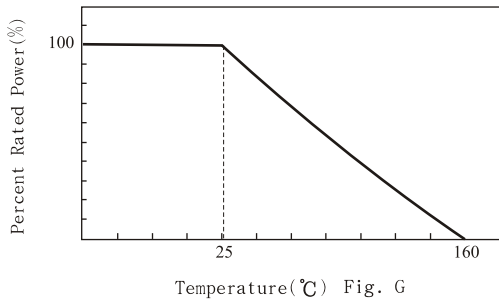

熱敏電阻的遞減曲線

熱敏電阻之最大電功率將隨其周邊溫度之變化而遞減。

(如圖G)

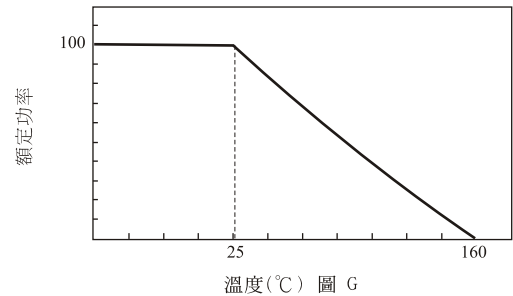

PARAMETERS DEFINITION

Thermistor

A thermistor is a thermally sensitive resistor of which its primary function is to exhibit a change in resistance accompanying with a change in itself temperature.

Negative Temperature Coefficient (NTC) Thermistor

NTC thermistor is a thermistor of which the zero-power resistance decreases while itself temperature is increased.

Inrush current

Inrush current is the initial surge of current that results when power is firstly applied to a load having a low starting impedance, such as a discharged capacitor, a cold lamp filament, or a stopped motor, etc.

Inrush current limiter

Specially designed and constructed NTC thermistor may be used as an inrush current limiter. JOYIN inrush current limiter(JNR) is available in a wide range of current handling and zero-power resistance value combinations.

Zero-power resistance(R₀)

The zero-power resistance is the direct current resistance value of a thermistor measured at a specified temperature "T" with a power dissipation by the thermistor low enough that any further decrease in power will result in less than 0.1 percent change in resistance.

Maximum steady-state current(I_{max}.)

The maximum steady-state current is the rating of the maximum current, normally expressed in amperes(A), allowable to be conducted by an inrush limiting NTC thermistor for an extended period of time.

Resistance at maximum current(R_{I_{max}}.)

The resistance at maximum current is the approximate resistance of an inrush current limiting thermistor, expressed in ohms(Ω), when it is conducting its rated maximum Steady-state current.

參數定義

熱敏電阻

熱敏電阻是一種對熱敏感的電阻器，其電阻值隨元件本身溫度變化而改變。

負溫度係數(NTC)熱敏電阻

NTC熱敏電阻是零功率電阻隨本身溫度上升而下降的電阻。

突波電流(衝擊電流)

譬如已放電的電容器，已冷卻的燈絲，或者一個靜止的馬達等等。有極低的起始阻抗，當負載的初期有較高的初始電流稱為衝擊電流。

突波電流抑制器

經過特殊設計和製造的NTC熱敏電阻就是一種突波電流抑制器。久尹製造的突波電流抑制器(JNR)有寬廣的電流及零功率電阻範圍可供搭配選擇。

零功率電阻(R₀)

在特定溫度(T)下，熱敏電阻所消耗之功率極低時所量到的直流電阻值。該電功率消耗低到如果電功率的再次下降，電阻值變化率仍小於0.1%。

最大穩定電流(I_{max}.)

NTC熱敏電阻能允許長時間通過的最大電流值，通常以安培(A)表示。

最大電流電阻(R_{I_{max}}.)

NTC熱敏電阻通過額定最大穩定電流時的殘餘電阻，以歐姆(Ω)表示。

Thermal dissipation coefficient(δ)

The thermal dissipation coefficient is the ratio, normally expressed in milliwatts per degree C(mW/°C), at a specified ambient temperature, of a change in power dissipation in a thermistor to the resultant body temperature change. ($\delta = V \times I / \Delta T$)

Thermal time Constant (τ)

The thermal time constant is the time required for a thermistor to change 63.2 percent of total difference between its initial and final body temperature when subjected to a step function change in ambient temperature under zero-power condition and is normally expressed in second.

Material constant(β)

The material constant of a NTC thermistor is a measure of its resistance at one temperature compared to its resistance at a different temperature. Its value may be calculated by the formula shown below and is expressed in degrees kelvin (°K). The reference temperature used in this formula for determining material constant rating of JOYIN thermistor is 298.15°K and 323.15°K $\beta = \text{Ln}(R_1/R_2) / (\frac{1}{T_1} - \frac{1}{T_2})$

Temperature coefficient of resistance(α_r)

The temperature coefficient of resistance is the ratio at a specified temperature T, of the rate of change of zero-power resistance with temperature to the zero-power resistance of the thermistor. The temperature coefficient is commonly expressed in percent per degree C(%/°C). $\alpha = 1/R \text{ dR/dT}$

Surge energy:

Surge energy is the maximum energy of pulses. The thermistor is capable of tolerating surge energy more than 1000 times with the resistance changing rate within $\pm 10\%$. This energy varies with voltage and capacitance.

Storage temperature range:-40 to +125°C

Operating temperature range:-30 to +125°C

WARNING

- The JNR thermistor shall not be touched by hand at the large power consumption for preventing burns.
- The JNR thermistor shall not be operated beyond the specified "Maximum Current" in the catalog.
- The JNR thermistor shall not be operated and stored under following environmental condition.
 - a. To be exposed directly to water or drop of water.
 - b. To be exposed directly to oil, gasoline or organic solvent and/or atmospheres of them.
 - c. Under condition of deoxidized or corrosive atmospheres such as chlorine, hydrogen sulfide, sulphur oxide and craked gas from vinyl chloride.....etc.

熱散逸係數(δ)

在一特定的環境溫度下,熱敏電阻電功率消耗對本體溫度變化量的比值,通常以mW/°C表示。
($\delta = V \times I / \Delta T$)

熱時常數(τ)

在零功率條件下,熱敏電阻之溫度依照「步級函數」下降到其最初溫度與最終溫度差之63.2%時所需的時間,通常以秒數(Sec.)表示。參考(圖F)。

材料常數(β)

材料常數又稱貝他常數,即NTC熱敏電阻在某一溫度之電阻與另一溫度之電阻的比較值,可由下面的公式計算得到,並以卡氏溫度(°K)表示之。

久尹的材料常數是 $T_1=298.15^\circ\text{K}$, $T_2=323.15^\circ\text{K}$
 $\beta = \text{Ln}(R_1/R_2) / (\frac{1}{T_1} - \frac{1}{T_2})$

電阻之溫度係數(α_r)

熱敏電阻在某一特定溫度(T),零功率電阻對溫度變化率及零功率電阻之比值,通常以(%/°C)表示。
 $\alpha = 1/R \text{ dR/dT}$

突波能量

熱敏電阻能承受最少6000次而電阻變化率在 $\pm 20\%$ 以內之突波能量。此能量與所加之電壓及電容值有關。可經由V-I圖形積分而得。

儲存溫度:-40 to +125°C

操作溫度:-30 to +125°C

注意事項:

- JNR熱敏電阻在大功率工作時不可用手直接碰觸。
- JNR熱敏電阻不可在超過目錄最大電流情況下工作。
- JNR產品工作或儲存環境注意事項:
 - a. 產品不可與水接觸
 - b. 產品不可與油、揮發性油類、有機溶劑接觸或曝露在油、揮發性油類、有機溶劑之氣氛中。
 - c. 產品不可在氯化物、硫酸、爆炸性氣體.....等還原或腐蝕氣氛下工作或儲存。



ORDERING CODE

JNR 05 S 050 M 6 5 Y AW

Joyin NTC Thermistor

Element Size(disc dia.)

- 05 = 5mm 07 = 7mm
- 08 = 8mm 09 = 9mm
- 10 = 10 mm 13 = 13mm
- 15 = 15mm 20 = 20mm

Series

S = Inrush current limiting

Resistance of thermistor at 25°C

- 0R7 = 0.7Ω 1R3 = 1.3Ω 1R5 = 1.5Ω 2R5 = 2.5Ω
- 030 = 3Ω 040 = 4Ω 050 = 5Ω 060 = 6Ω
- 070 = 7Ω 080 = 8Ω 100 = 10Ω 120 = 12Ω
- 130 = 13Ω 150 = 15Ω 160 = 16Ω 180 = 18Ω
- 200 = 20Ω 220 = 22Ω 250 = 25Ω 300 = 30Ω
- 470 = 47Ω 500 = 50Ω 800 = 80Ω 121 = 120Ω
- 221 = 220Ω

Tolerance

- L = ± 15%
- M = ± 20%

Lead Wire Diameter

- 6 = 0.6 ± 0.05mm
- 8 = 0.8 ± 0.05mm
- 1 = 1.0 ± 0.05mm

Lead Length & Packaging

- U4 = 24mm min. for Bulk and Kink lead
- U5 = 25mm min. for Bulk and Straight lead
- AW= H0 16mm for Ammo and Kink lead
- AY = H0 20mm for Ammo and Straight lead
- RW= H0 16mm for T/R and Kink lead
- RY = H0 20mm for T/R and Straight lead

* Special lead length & packaging per request.

Lead Style

- Y=Vertical Kink Lead (standard)
- P=Straight Lead

* Special lead styles per request

Lead Spacing

- 5=5.0mm
- 7=7.5mm
- 1=10mm

Dimension Table

unit:mm

Diameter	5mm	7mm	8mm	9mm	10mm	13mm	15mm	20mm
D max.	7.0	9.0	10.0	11.0	12.0	15.0	17.5	23.0
$d \pm 0.05$	0.6	0.6	0.6	0.6	0.8	0.8	0.8	1.0
$F \pm 1.0$	5.0	5.0	5.0	5.0	7.5	7.5	7.5	10.0
H max.	11.0	13.0	14.0	17.0	18.0	21.0	23.0	28.0
H1 max.	10.0	12.0	13.0	15.0	17.0	19.0	22.0	27.0
L1 min.	25.0	25.0	25.0	25.0	25.0	25.0	25.0	25.0
L min.	24.0	24.0	24.0	24.0	24.0	24.0	24.0	24.0

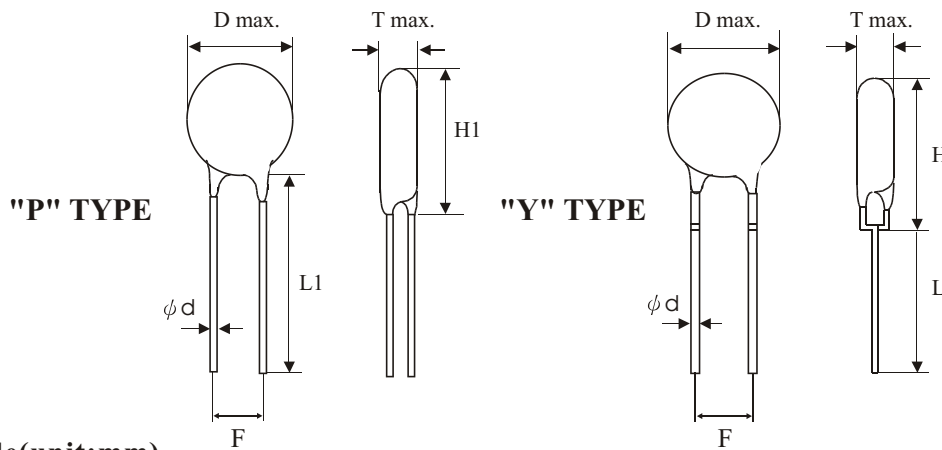

T max. Table(unit:mm)

Part No.	5mm	7mm	8mm	9mm	10mm	13mm	15mm	20mm
0R7M	---	---	---	---	---	---	---	6.0
1R3M	---	---	---	---	---	5.0	5.0	6.0
1R5M	---	---	---	---	---	---	5.0	---
2R5M	---	---	---	---	5.0	5.5	6.5	6.0
4R7M	---	---	4.5	---	---	---	---	---
030M	---	---	---	4.5	5.0	6.0	6.5	---
040M	---	---	4.5	---	5.5	---	5.5	---
050M	---	4.5	4.5	4.5	5.5	5.0	6.5	6.0
060L	---	---	4.5	---	6.0	5.0	7.0	6.0
070L	---	---	5.0	---	6.0	6.0	5.0	---
080L	---	4.5	5.5	5.5	7.0	6.5	5.0	---
100L	5.0	5.0	5.5	6.5	6.0	7.5	5.5	7.0
120L	---	5.0	---	5.5	7.0	5.5	5.5	7.5
130L	---	---	---	---	6.0	---	---	---
150L	---	---	5.0	---	7.0	5.5	6.0	---
160L	---	5.0	---	7.0	5.0	5.5	6.0	---
180L	---	---	5.0	---	---	6.0	6.5	---
200L	5.0	---	5.5	---	5.5	6.0	6.5	---
220L	---	5.5	5.5	7.0	---	---	---	---
250L	---	---	---	---	5.5	6.5	5.5	---
300L	---	6.0	---	---	6.0	---	5.5	---
400L	---	---	---	---	---	---	6.0	---
470L	---	---	---	---	6.5	---	6.5	---
500L	---	6.0	---	6.0	7.0	6.0	---	---
800L	---	---	---	---	6.0	---	5.5	---
121L	---	---	---	---	6.5	---	6.0	8.0
221L	---	---	---	---	---	---	7.0	---



JNR THERMISTOR SPECIFICATIONS

Ordering Code	Resistance at 25°C	Tolerance	I _{max}	R _I max	Thermal dissipation coefficient	Thermal Time constant	Maximum Capacitance AC(μF)	Material constant B(±10%)	Certification
	(Ohms)								
JNR05S100L	10	±15%	1	0.848	12	50	47	2750	★
JNR05S200L	20	±15%	0.3	0.246	12	50	47	2750	★
JNR07S050M	5	±20%	3.0	0.171	10	45	47	2750	★
JNR07S080L	8	±15%	2.5	0.245	10	45	47	2750	★
JNR07S100L	10	±15%	2.3	0.298	11	45	68	2750	★
JNR07S120L	12	±15%	2.3	0.327	13	50	100	2750	★
JNR07S160L	16	±15%	2.0	0.516	13	50	100	2800	★
JNR07S220L	22	±15%	1.5	0.714	13	51	100	2800	★
JNR07S300L	30	±15%	1.5	0.771	13	51	100	2800	★
JNR07S500L	50	±15%	1.2	0.638	13	46	100	3100	★
JNR08S040M	4	±20%	2.0	0.274	13	42	100	2750	★
JNR08S4R7M	4.7	±20%	2.0	0.285	13	42	100	2750	★
JNR08S050M	5	±20%	2.0	0.348	16	55	100	2750	★
JNR08S060L	6	±15%	2.0	0.325	16	55	100	2750	★
JNR08S070L	7	±15%	2.0	0.387	16	44	100	2750	★
JNR08S080L	8	±15%	2.0	0.720	16	44	100	2750	★
JNR08S100L	10	±15%	2.0	0.357	12	44	100	2750	★
JNR08S150L	15	±15%	2.0	0.375	12	47	100	2850	★
JNR08S180L	18	±15%	2.0	0.442	12	47	100	2850	★
JNR08S200L	20	±15%	1.0	0.460	12	47	100	2850	★
JNR08S220L	22	±15%	1.0	1.238	12	57	100	2850	★
JNR09S030M	3	±20%	4.0	0.121	17	56	68	2750	★
JNR09S050M	5	±20%	3.8	0.143	17	63	68	2750	★
JNR09S080L	8	±15%	3.5	0.139	17	77	100	2750	★
JNR09S100L	10	±15%	3.0	0.172	17	88	100	2750	★
JNR09S120L	12	±15%	3.0	0.408	17	99	100	2800	★
JNR09S160L	16	±15%	2.5	0.359	17	103	100	2800	★
JNR09S220L	22	±15%	2.0	0.402	19	79	150	2850	★
JNR09S500L	50	±15%	1.4	0.392	17	66	150	3100	★
JNR10S2R5M	2.5	±20%	5.0	0.653	14	45	150	2750	★
JNR10S030M	3	±20%	4.0	0.103	15	45	150	2750	★
JNR10S040M	4	±20%	4.0	0.139	17	45	150	2750	★
JNR10S050M	5	±20%	4.0	0.153	17	80	150	2750	★
JNR10S060L	6	±15%	3.0	0.969	17	80	330	2750	★
JNR10S070L	7	±15%	3.0	0.258	18	80	330	2750	★
JNR10S080L	8	±15%	3.0	0.286	19	80	330	2750	★
JNR10S100L	10	±15%	3.0	0.298	19	86	330	2800	★
JNR10S120L	12	±15%	2.5	0.379	19	86	330	2800	★
JNR10S130L	13	±15%	2.5	0.406	19	88	330	2850	★
JNR10S150L	15	±15%	2.5	0.428	18	88	330	2850	★
JNR10S160L	16	±15%	2.5	0.283	18	57	330	3100	★
JNR10S200L	20	±15%	2.0	0.501	19	57	330	3100	★
JNR10S250L	25	±15%	2.0	0.517	19	57	330	3100	★
JNR10S300L	30	±15%	2.0	0.579	19	64	330	3100	★
JNR10S470L	47	±15%	2.0	0.691	20	70	330	3100	★
JNR10S500L	50	±15%	2.0	0.787	22	97	330	3100	★
JNR10S800L	80	±15%	1.0	1.928	17	66	390	3400	★
JNR10S121L	120	±15%	1.0	2.342	17	95	390	3400	★



JNR THERMISTOR SPECIFICATIONS

Ordering Code	Resistance at 25°C	Tolerance	I _{max}	R _I max	Thermal dissipation coefficient	Thermal Time constant	Maximum Capacitance AC(μF)	Material constant B(±10%)	Certification
	(Ohms)								
JNR13S1R3M	1.3	±20%	7.0	0.048	19	68	47	2750	☆
JNR13S2R5M	2.5	±20%	5.0	0.098	21	92	68	2750	☆
JNR13S030M	3	±20%	5.0	0.106	22	95	68	2750	☆
JNR13S050M	5	±20%	5.0	0.083	22	110	100	2850	☆
JNR13S060L	6	±15%	5.0	0.157	22	110	150	2850	☆
JNR13S070L	7	±15%	4.0	0.287	22	110	330	2850	☆
JNR13S080L	8	±15%	4.0	0.306	22	110	330	2850	☆
JNR13S100L	10	±15%	4.0	0.126	22	110	330	2850	☆
JNR13S120L	12	±15%	3.0	0.267	18	75	390	3100	☆
JNR13S150L	15	±15%	3.0	0.338	18	82	560	3100	☆
JNR13S160L	16	±15%	3.0	0.310	18	82	560	3100	☆
JNR13S180L	18	±15%	2.8	0.372	22	82	470	3100	☆
JNR13S200L	20	±15%	2.8	0.340	22	82	470	3100	☆
JNR13S250L	25	±15%	2.0	0.664	22	94	560	3100	☆
JNR13S500L	50	±15%	2.0	0.201	22	94	560	3400	☆
JNR15S1R3M	1.3	±20%	8.0	0.047	23	94	47	2750	☆
JNR15S1R5M	1.5	±20%	8.0	0.049	23	94	100	2750	☆
JNR15S2R5M	2.5	±20%	8.0	0.062	23	112	150	2750	☆
JNR15S030M	3	±20%	7.0	0.082	23	150	330	2750	☆
JNR15S040M	4	±20%	6.0	0.112	24	110	330	2850	☆
JNR15S050M	5	±20%	6.0	0.111	25	110	390	2850	☆
JNR15S060L	6	±15%	5.0	0.137	25	114	390	2850	☆
JNR15S070L	7	±15%	5.0	0.117	19	72	470	3100	☆
JNR15S080L	8	±15%	5.0	0.126	21	76	470	3100	☆
JNR15S100L	10	±15%	5.0	0.140	21	96	560	3100	☆
JNR15S120L	12	±15%	4.0	0.206	21	100	560	3100	☆
JNR15S150L	15	±15%	4.0	0.224	21	120	680	3100	☆
JNR15S160L	16	±15%	4.0	0.219	26	120	680	3100	☆
JNR15S180L	18	±15%	4.0	0.244	26	125	680	3100	☆
JNR15S200L	20	±15%	4.0	0.248	26	125	680	3100	☆
JNR15S250L	25	±15%	3.0	0.321	19	84	680	3400	☆
JNR15S300L	30	±15%	3.0	0.349	24	97	680	3400	☆
JNR15S400L	40	±15%	3.0	0.398	25	99	1000	3400	☆
JNR15S470L	47	±15%	3.0	0.414	25	123	1000	3400	☆
JNR15S800L	80	±15%	2.5	0.492	25	94	680	3600	☆
JNR15S121L	120	±15%	2.0	0.906	25	97	1000	3600	☆
JNR15S221L	220	±15%	1.0	2.917	25	138	1500	3600	☆
JNR20S0R7M	0.7	±20%	12.0	0.037	29	118	470	2750	☆
JNR20S1R3M	1.3	±20%	8.0	0.057	31	157	470	2750	☆
JNR20S2R5M	2.5	±20%	8.0	0.080	31	98	330	2850	☆
JNR20S050M	5	±20%	7.0	0.095	31	90	390	3100	☆
JNR20S060L	6	±15%	6.0	0.120	31	118	470	3100	☆
JNR20S080L	8	±15%	6.0	0.119	31	130	470	3100	☆
JNR20S100L	10	±15%	6.0	0.130	37	152	560	3100	☆
JNR20S120L	12	±15%	5.0	0.214	37	210	680	3100	☆
JNR20S121L	120	±15%	2.0	2.993	22	215	1500	3600	☆



5mm

V-I Characteristics Chart

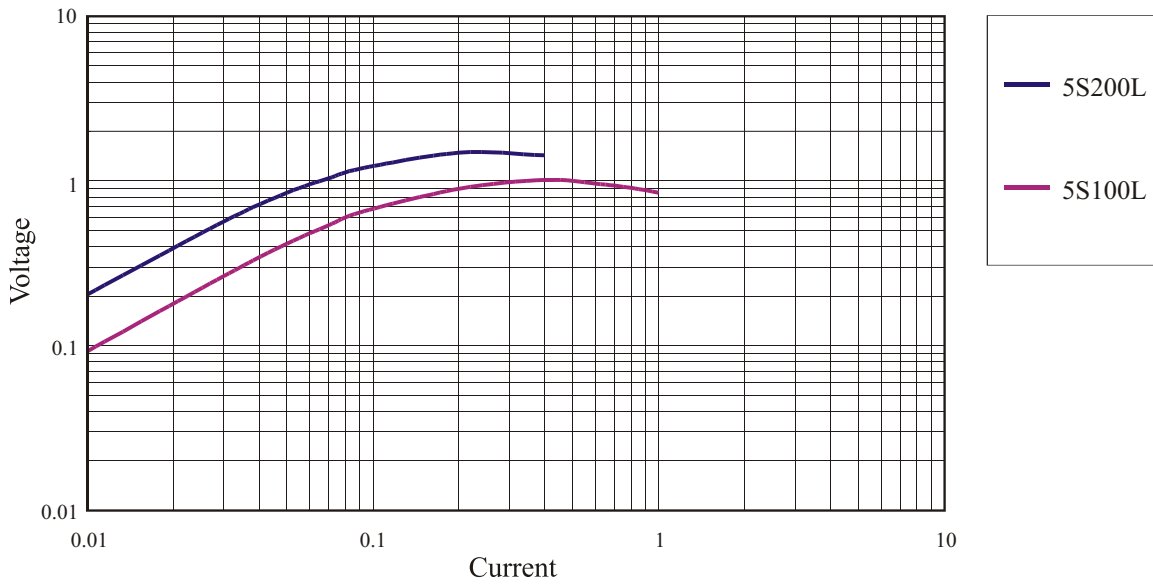

R-T Curve

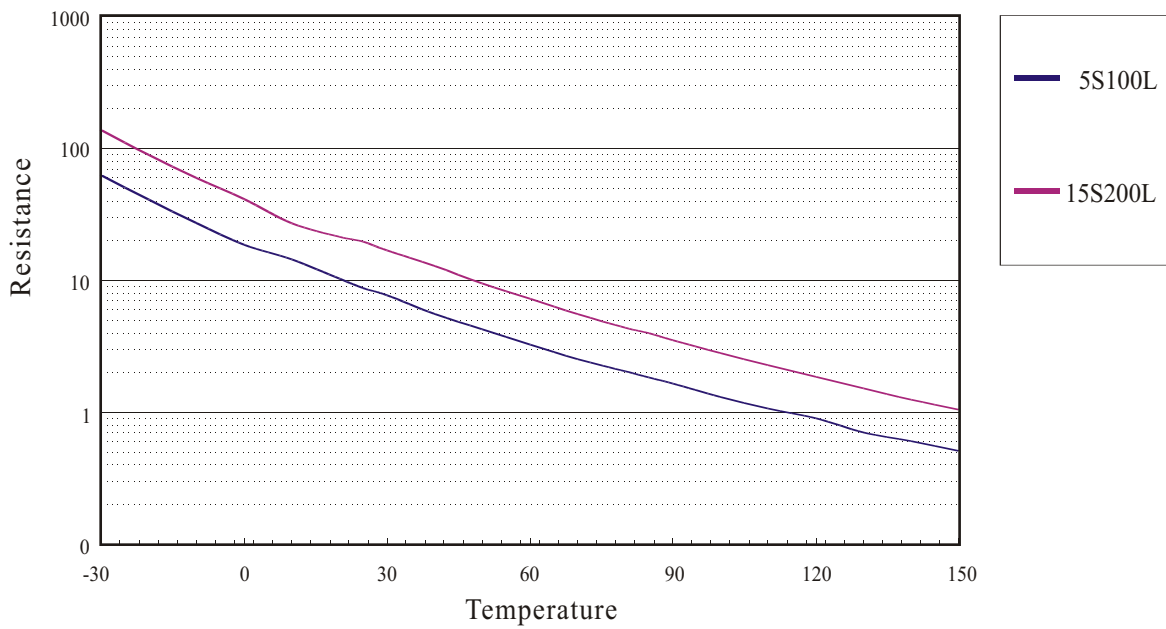

7mm

V-I Characteristics Chart

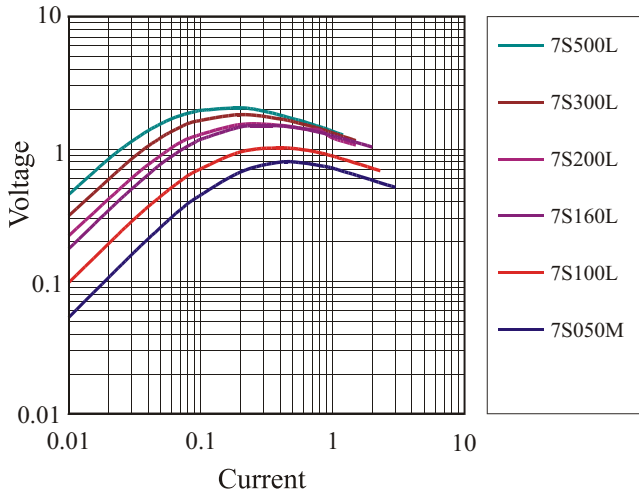

V-I Characteristics Chart

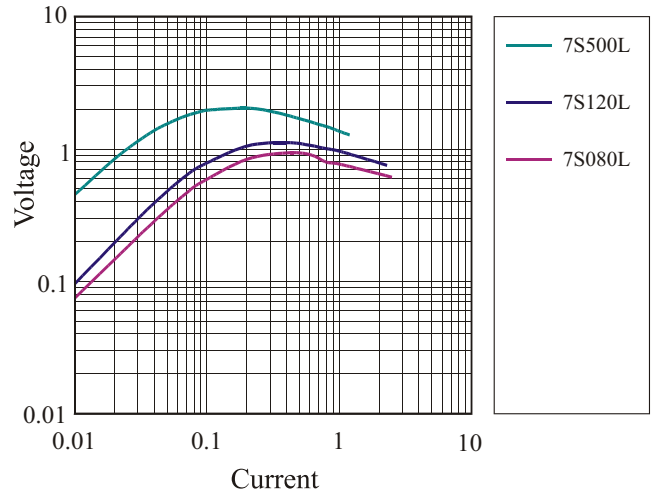

R-T Curve

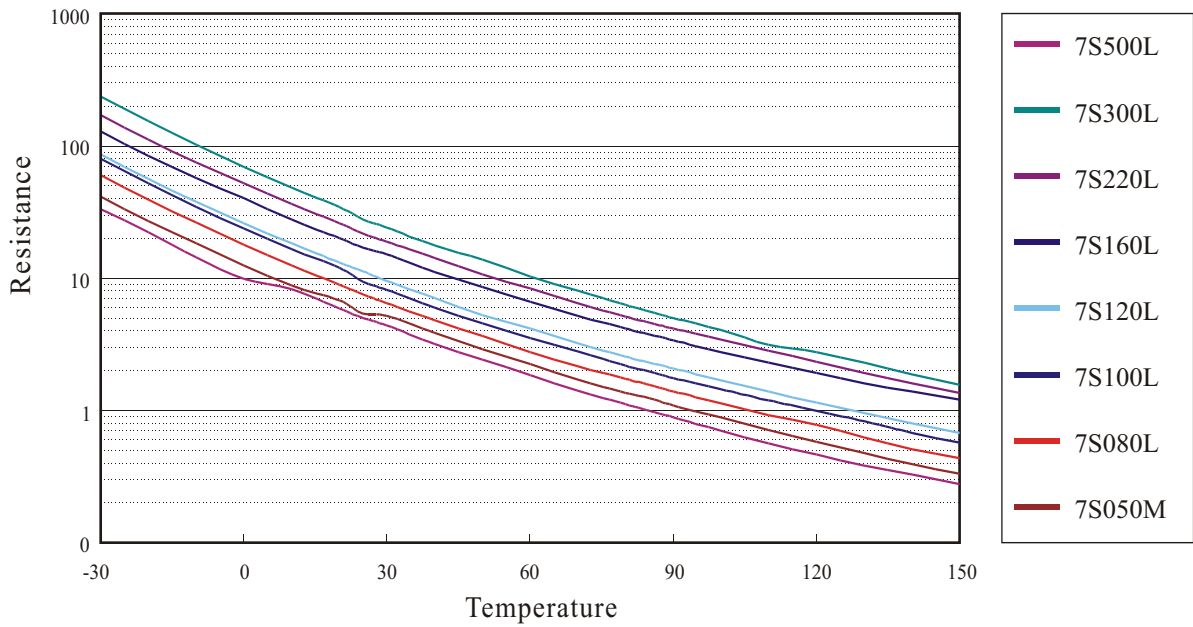



8mm

V-I Characteristics Chart

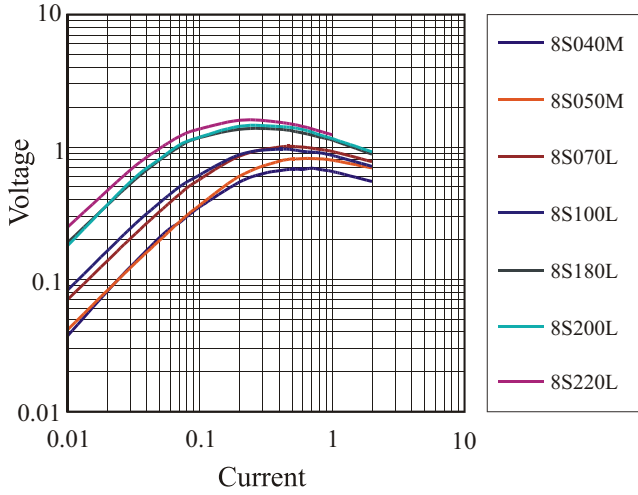

V-I Characteristics Chart

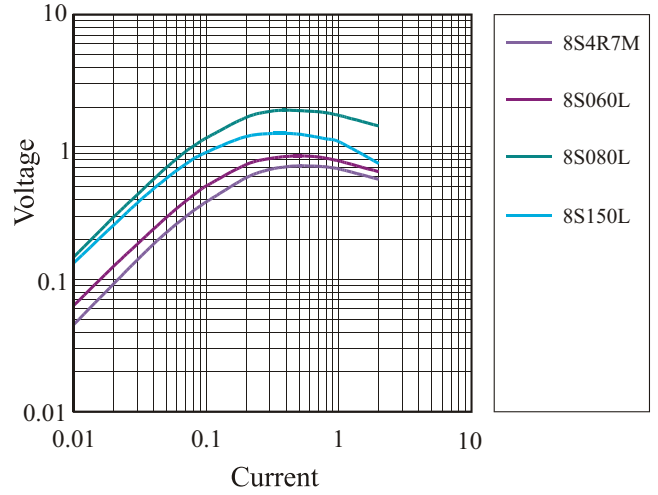

R-T Curve

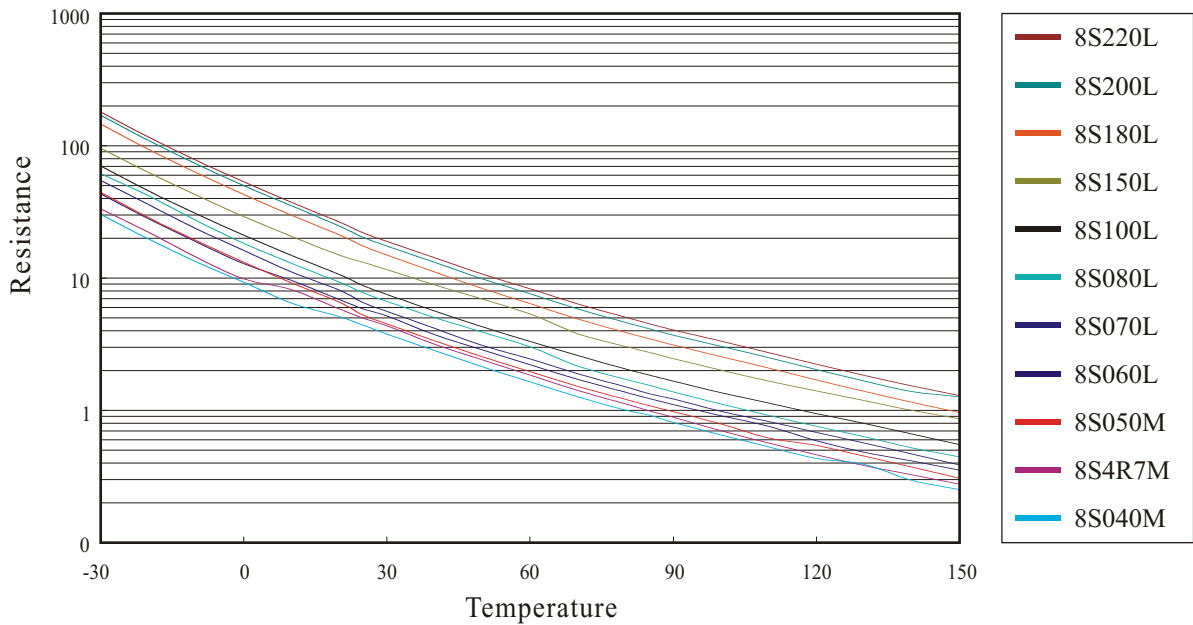

9mm

V-I Characteristics Chart

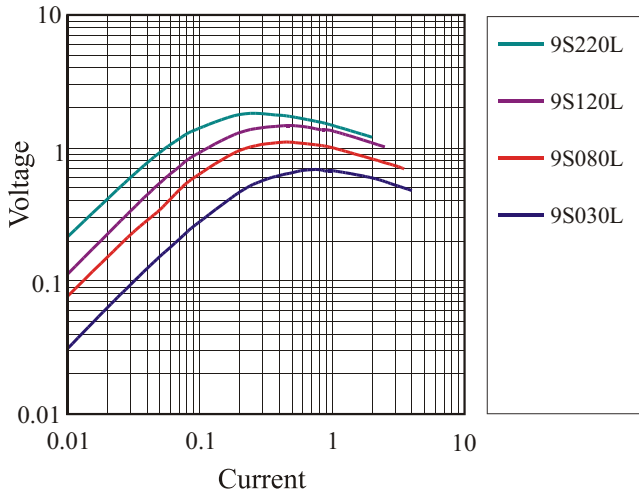

V-I Characteristics Chart

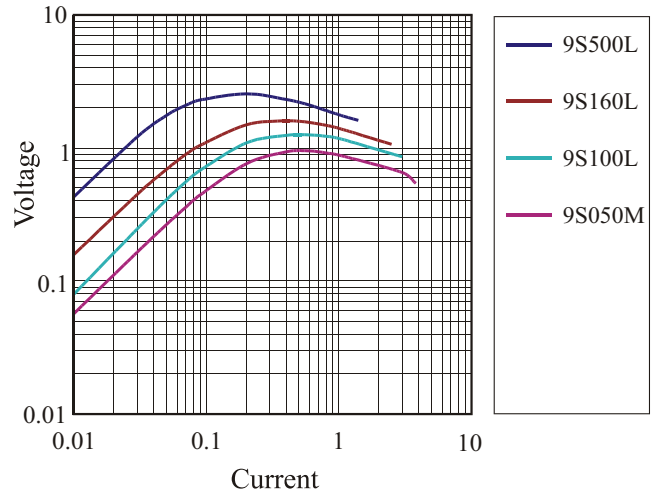

R-T Curve

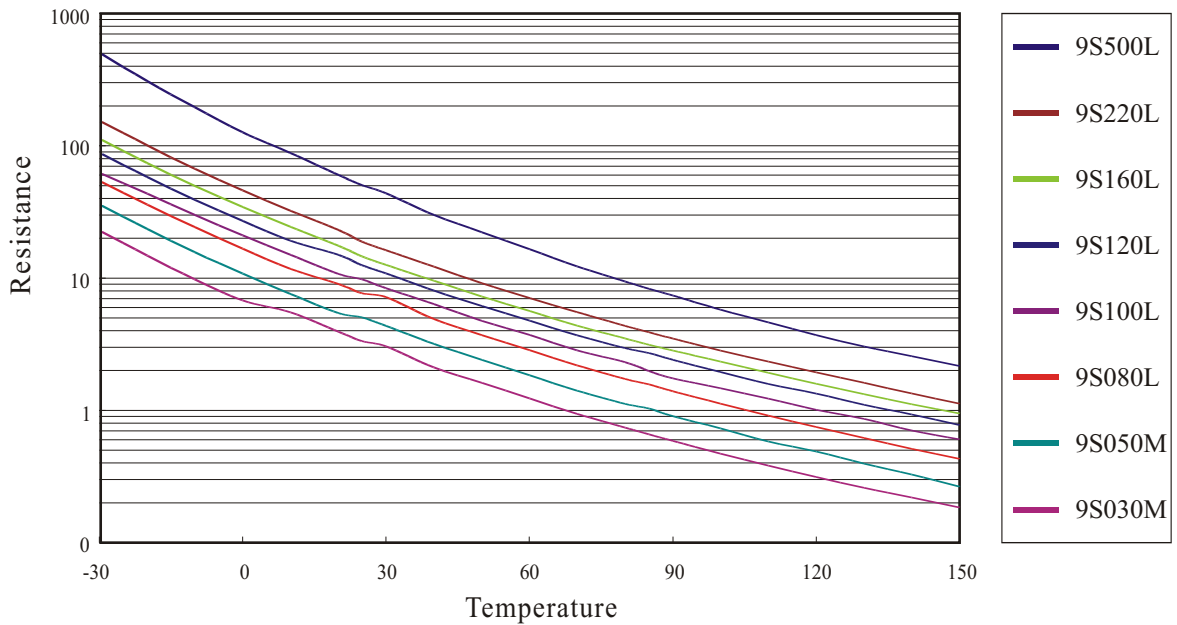



10mm

V-I Characteristics Chart

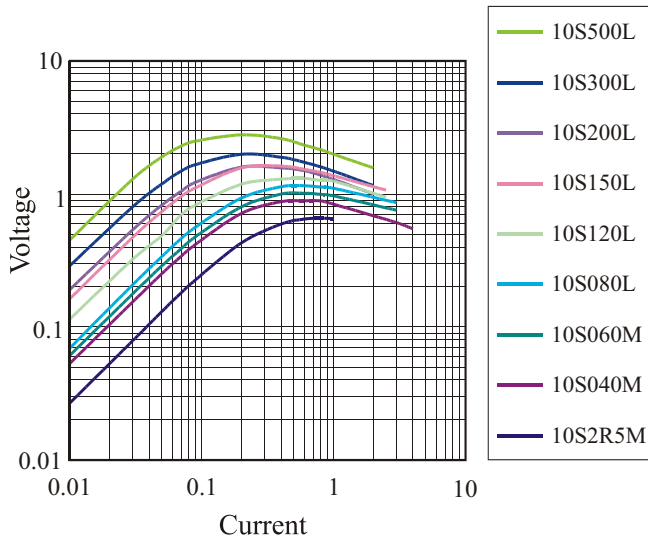

V-I Characteristics Chart

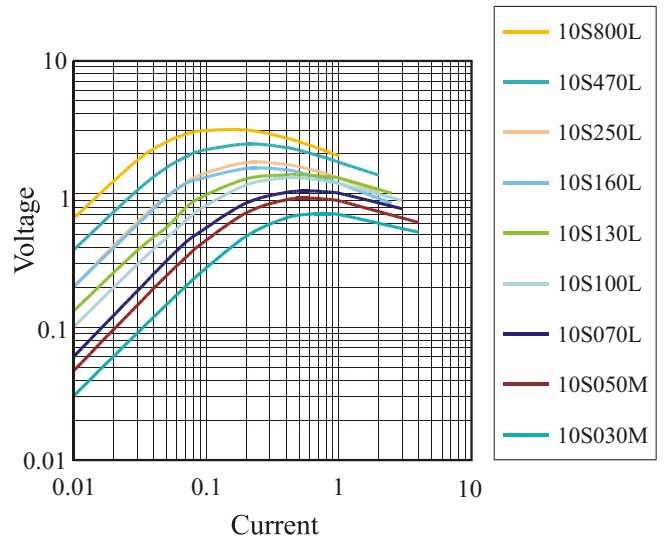

R-T Curve

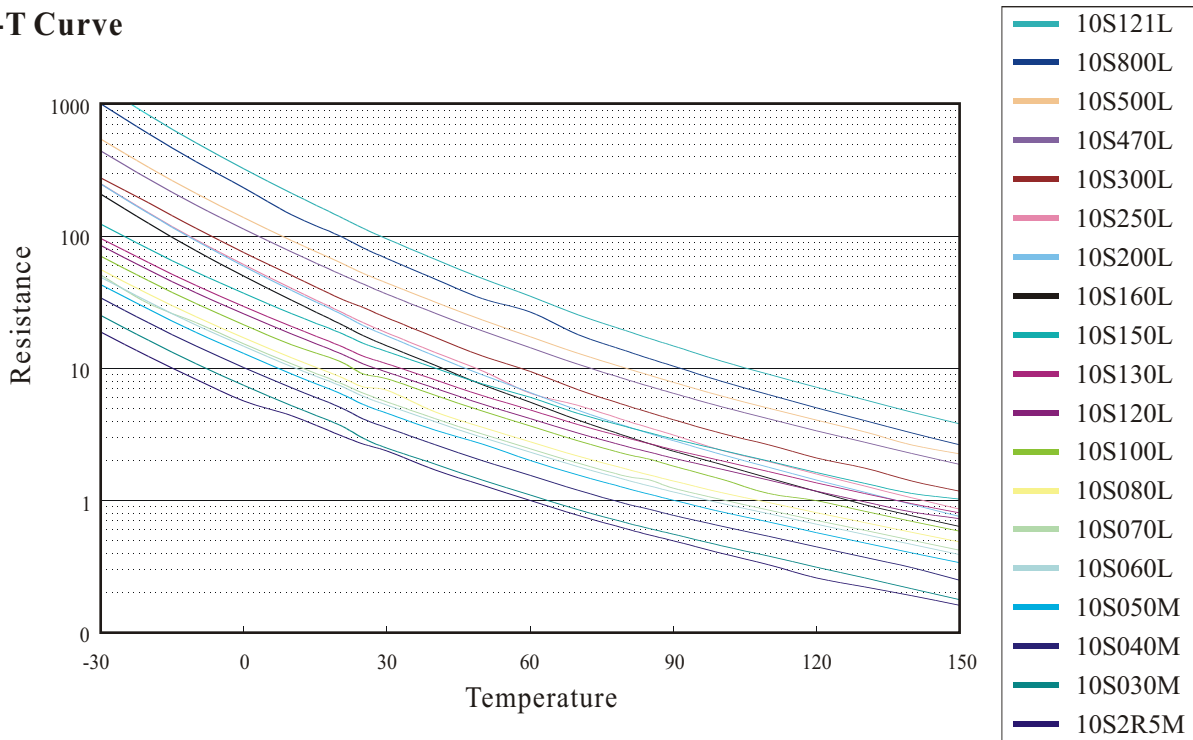

13mm

V-I Characteristics Chart

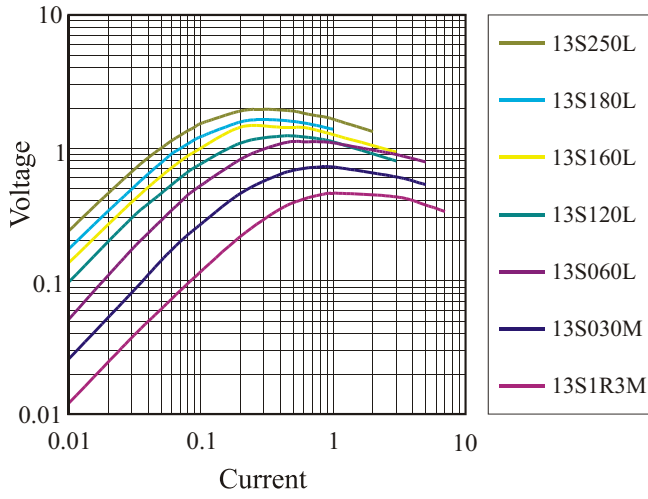

V-I Characteristics Chart

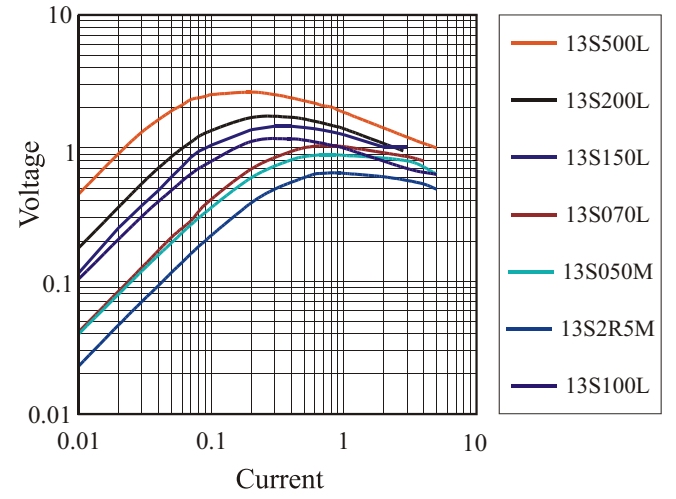

R-T Curve

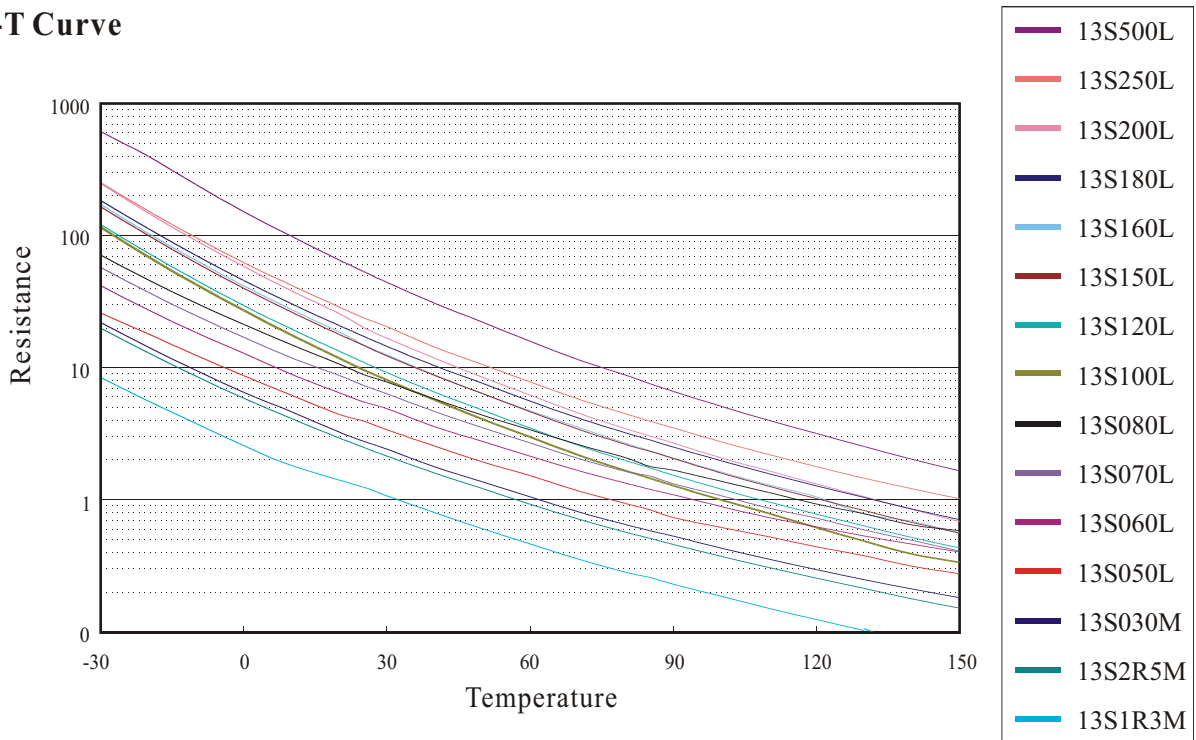



15mm

V-I Characteristics Chart

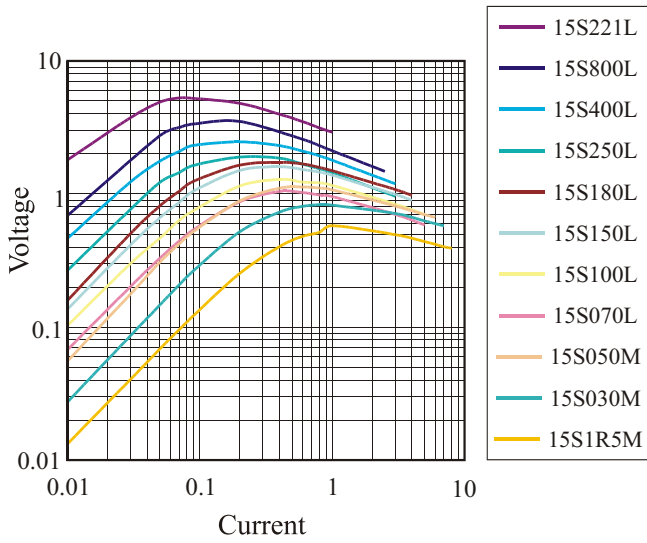

V-I Characteristics Chart

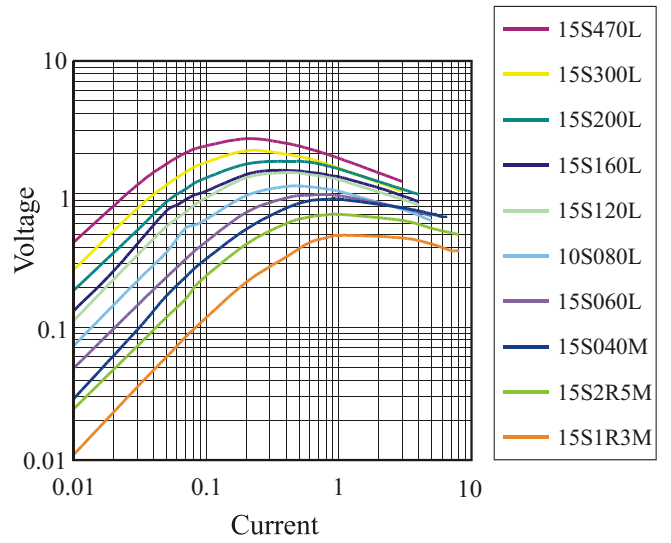

R-T Curve

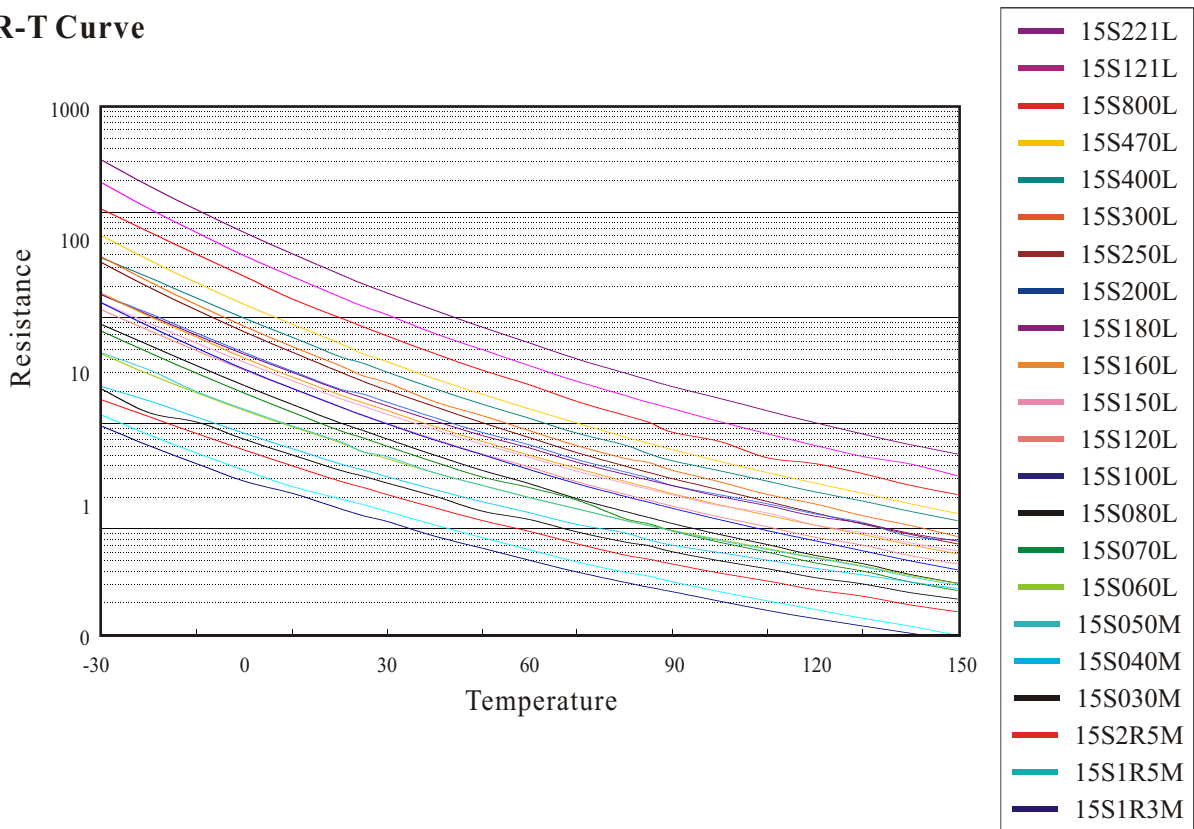

20mm

V-I Characteristics Chart

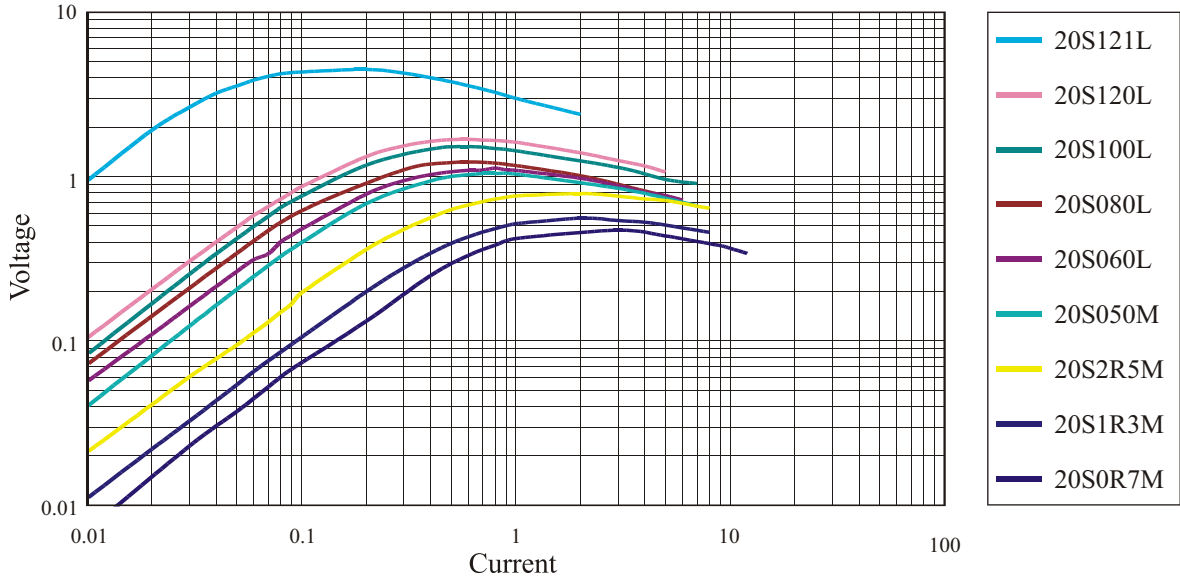

R-T Curve

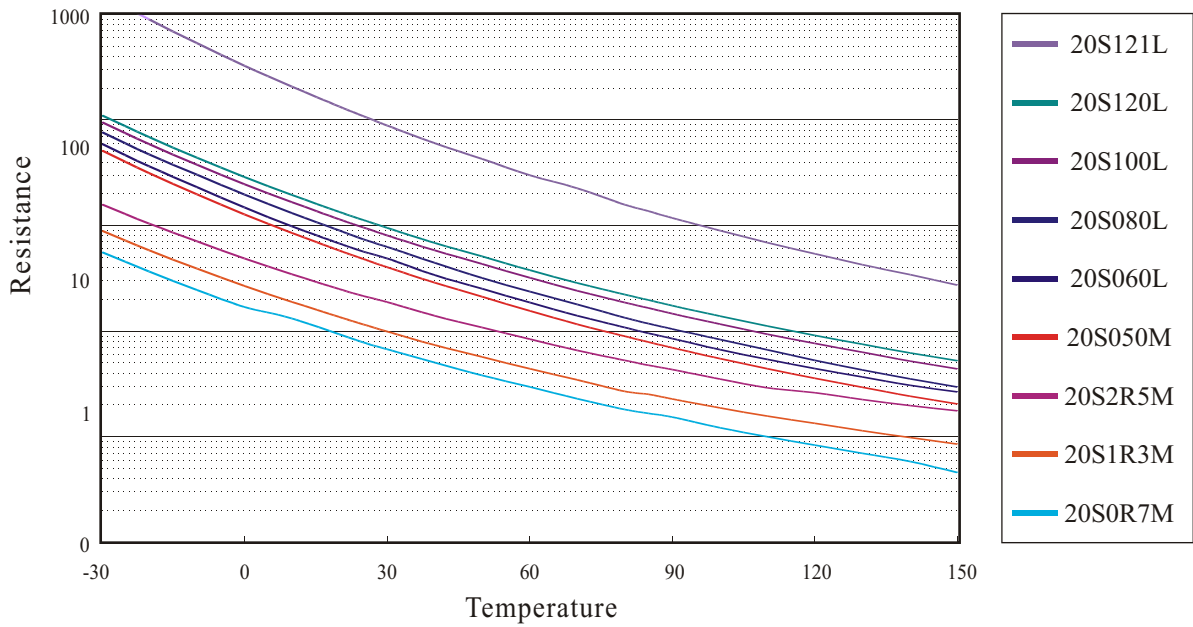



Tape and Reel Dimensions

1/2" pitch

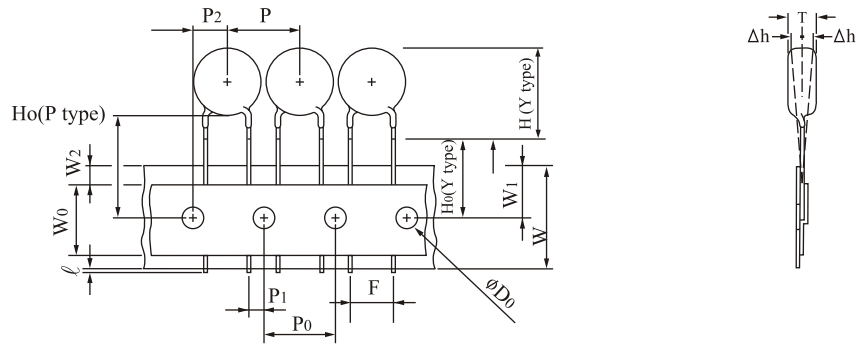

1.0" pitch

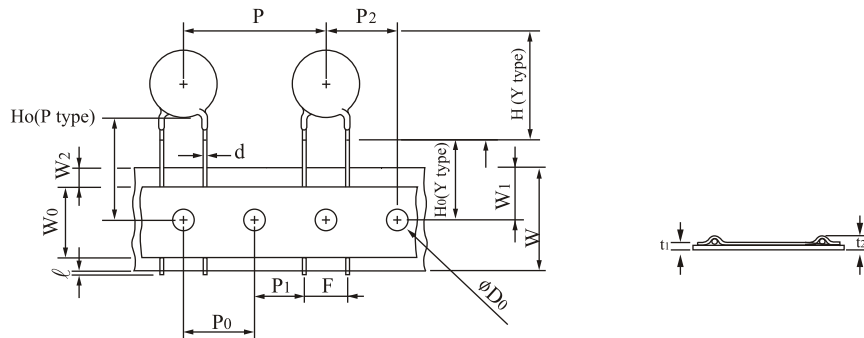

Symbols	Item	5/7/8/9/10mm	8/9/10/13/15/20mm	20mm
ℓ	Cut out length	1.1 mm max.	1.1 mm max.	
H (Y type)	Height of Top	See H max. table		
Ho(Y type)	Height to seating plane	16.0 ± 0.5 mm	16.0 ± 0.5 mm	
Ho(P type)	Height of component from hole center	16.0~21.0 mm	16.0~21.0 mm	
Δh	Front to back deviation	0 ± 2.0 mm	0 ± 2.0 mm	
W	Carrier tape width	18.0 ^{+1.0} / _{-0.5} mm	18.0 ^{+1.0} / _{-0.5} mm	
W ₀	Hold down tape width	10.0 mm	12.0 mm	
W ₁	Sprocket hole position	9.0 ^{+0.75} / _{-0.5} mm	9.0 ^{+0.75} / _{-0.5} mm	
W ₂	Adhesive tape position	3.0 mm max.	3.0 mm max.	
F	Component lead spacing	5.0 ^{+0.8} / _{-0.2} mm	7.5 ^{+0.8} / _{-0.2} mm	10.0 ^{+0.8} / _{-0.2} mm
P	Pitch of component	12.7 ± 1.0 mm	25.4 ± 1.0 mm	
P ₀	Sprocket hole pitch	12.7 ± 0.3 mm	12.7 ± 0.3 mm	
P ₁	Lead length from hole center to lead	3.85 ± 0.7 mm	8.95 ± 0.7 mm	7.7 ± 0.7 mm
P ₂	Length from hole center to disk center	6.35 ± 1.3 mm	12.7 ± 1.3 mm	
D ₀	Sprocket hole diameter	4.0 ± 0.2 mm	4.0 ± 0.2 mm	
d	Lead wire diameter	0.6 ± 0.05 mm	0.8 ± 0.05 mm	1.0 ± 0.05 mm
T	Disk thickness	See T max. table	See T max. table	
t ₁	Total thickness tape	0.7 ± 0.05 mm	0.7 ± 0.05mm	
t ₂	Total thickness	1.6 mm max.	1.8 mm max.	

MARKING

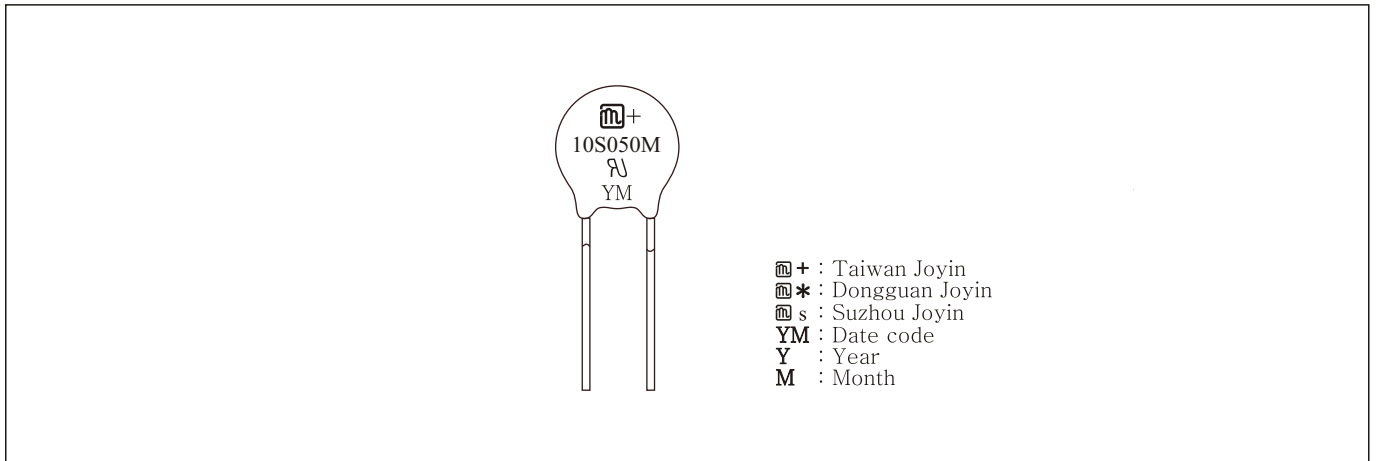

PACKAGING

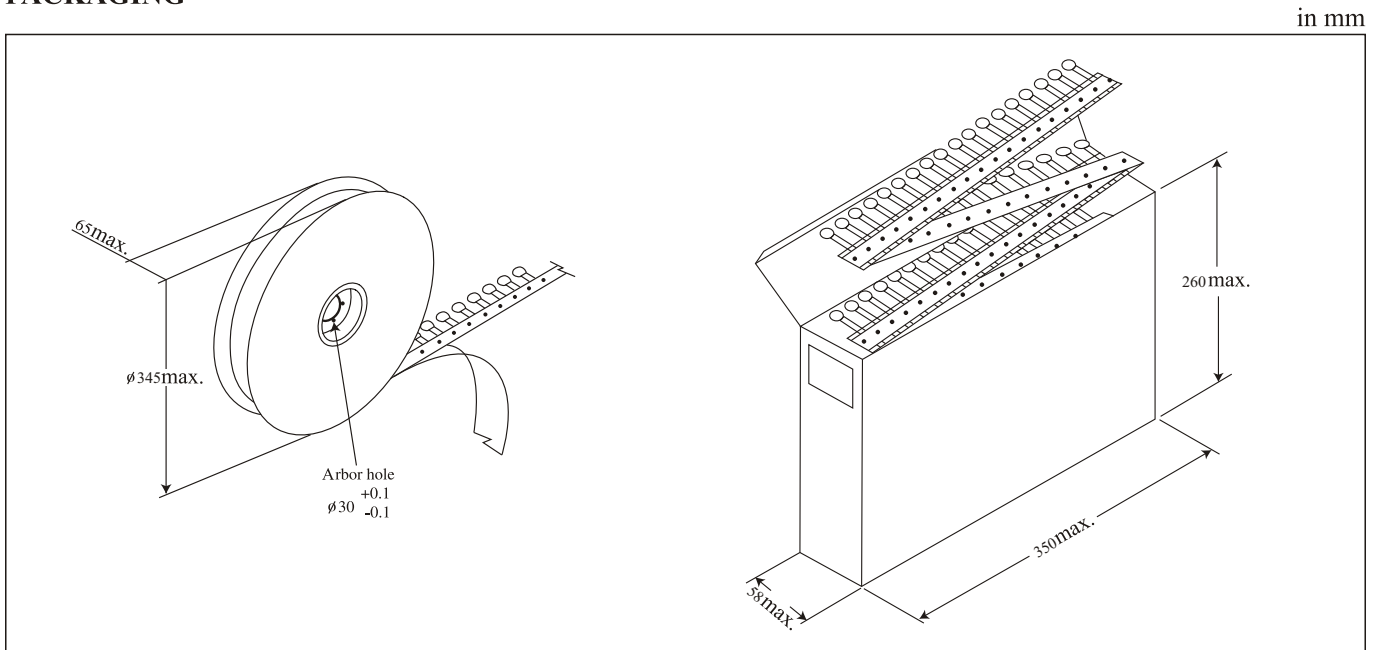

Quantity per Packing Unit

Diameter \ Packaging	5mm	7mm	8mm	9mm	10mm	13mm	15mm	20mm
Bulk (pcs/box)	5000	5000	4000	1250-2500	1250-2500	750-2000	750-1500	500-750
Reel	1500	1500	1500	750-1000	750-1000	750-1000	500-750	—
Ammo	1500	1500	1500	750-1000	750-1000	750-1000	—	—

Packaging	Bulk (box)	Reel	Reel (15mm, 20mm)	Ammo (5mm, 7mm)	Ammo (10mm, 15mm) 180K-471K	Ammo (10mm, 15mm) 511-751K	Ammo (20mm) 180K-471K
Box size (mm)	290x155x110	350x350x108	350x350x74	330x240x46	343x210x52	343x260x52	343x220x58
Carton size (mm)	310x328x250	371x371x590	370x370x468	350x500x270	363x440x250	363x540x250	363x460x250
One carton with	4 Boxes	5 Boxes (10 reels)	6 Boxes(6 reels)	10 Boxes	8 Boxes	8 Boxes	8 Boxes